

AUSTRALIAN DEFENCE FORCE  
FLIGHT INFORMATION PUBLICATION  
(EN ROUTE)



**FLIGHT INFORMATION HANDBOOK  
AUSTRALIA**

Effective: **28 NOV 24**

Next Issue: **20 MAR 25**

**WARNING**

**Consult AsA SUP/AIC and NOTAM for latest information**





© Commonwealth of Australia 2024

This work is copyright. Apart from any use as permitted under the *Copyright Act 1968*, no part may be reproduced by any process without prior written permission from the Commonwealth. Requests and inquiries concerning reproduction and rights should be addressed to the Commonwealth Copyright Administration, Attorney General's Department, National Circuit, Barton ACT 2600 or posted at <http://www.ag.gov.au/> copyright. Alternatively, contact the Department of Defence, AIS-AF, VBM-M-2, Victoria Barracks, St Kilda Road, Southbank VIC 3006 or mail your request/inquiry to: Department of Defence, AIS-AF, GPO Box 393, VBM-M-2, Melbourne VIC 3001.

## SUMMARY OF NOTEWORTHY AMENDMENTS

*Note 1: This summary does not necessarily include all details of the amendment and should not be substituted for reading the amended text.*

*Note 2: Not all amendments are included in this summary - only those amendments considered noteworthy.*

Airservices is working towards the introduction of an electronic Aeronautical Information Publication (eAIP) to align, as far as practicable, with ICAO specifications. Content that is no longer current, duplicated, of an informative rather than instructional nature or contained in other documents (such as legislation, guides or websites), is being removed from the AIP and consequently FIHA.

AIP content that is owned by CASA refers to legislation and guidance material that is being amended WEF 02 December 2021. The AIP will be aligned with these changes, which includes multiple references to CASA guidance material that will not be available after 02 December, resulting in extensive deletion or replacement and involves significant paragraph re-numbering.

### 28 NOV 24

#### **Holding Approach and Departure Procedures.**

Updating the visual approach requirements that apply to IFR flights, VFR flights and what applies to both. *ENR 1.5 para 1.14, 1.15, 1.16 and 1.23.*

#### **Military Airspace.**

Amberley and Williamstown restricted airspace updated in *ENR 5.2 - para 2.3 and 2.9.*

#### **Other Activities of Dangerous Nature and Potential Hazards.**

Existing information moved from ERSA, Special Procedures, Fly Neighbourly Advice GEN-SP FN22 and FN24, around bushfires and warships. Volcanic ash hazards included with reference to newly created *AC 91-33. ENR 5.3.*

#### **Balloon Operations.**

Reflect new requirements as stated in *Part 131 MOS* and including statement referencing *AC 131-02 and AIP SUP H118/21 - ENR 5.5, para 3.3.1 and 3.3.2.*





## GEN 0.1 PREFACE

### 1. NAME OF PUBLISHING AUTHORITY

1.1 FIHA is issued by AIS-AF under the authority of the Defence Aviation Authority (Defence AA).

### 2. APPLICABLE DOCUMENTS

2.1 FIHA is prepared in accordance with the Standards and Recommended Practices of the following ICAO documents:

- a. Facilitation - Annex 9
- b. Aeronautical Information Services - Annex 15
- c. Aeronautical Information Services Manual (Doc 8126-AN/872)
- d. Aeronautical Charts - Annex 4
- e. Aeronautical Chart Manual (Doc 8697-AN/889/2)

### 3. ADF AIP - DOCUMENTS INVOLVED

3.1 ADF AIP is designed to be used as a complete package and component documents include FIHA, GPA and aeronautical charts, and should not be used in isolation without reference to other applicable components of the ADF AIP.

3.2 **CASA Publications Applicability.** References to Civil Aviation Safety Authority Airworthiness Circulars (AC), Civil Aviation Advisory Publications (CAAP) or Manuals of Standards (MOS) direct the user to explanatory information and airmanship considerations associated with the related rules and procedures. Military and State aviation operations are not bound by civil regulation, however, these publications augment knowledge and understanding of the intended outcomes when conducting those operations. AC, CAAP or MOS information do not override authorised military OIP.

3.3 **Publication hierarchy.** To ensure conflicts between operational documents do not lead to confusion between the flight crew and service provider, within Australian airspace the following Orders, Instructions and Publication (OIP) hierarchy applies where there are differences between the civil Aeronautical Information Publication Australia (AIP AUS), the Defence General Planning Australia (GPA) and Flight Information Handbook Australia (FIHA), the joint civil-military Manual of Air Traffic Services (MATS) and 44 Wing Military Air Traffic Manual (MATMAN):

- a. AIP AUS, GPA and FIHA have precedence over MATS and MATMAN.
- b. For military aircraft and approved operators, GPA and FIHA have precedence over AIP AUS.

3.4 When a conflict between GPA or FIHA and other documents is identified, notify HQAC A9 OPAW (hqac.a9opaw@defence.gov.au) with details.

3.5 When a conflict between MATS or MATMAN and ADF AIP is identified, notify HQSRG A7 ANSP STAND (hqsrgr7.anspstand@defence.gov.au) with details.

### 4. LAYOUT

4.1 **Purpose.** The purpose of FIHA is to consolidate important planning, procedures and regulatory information of a lasting nature, relevant to ADF flying operations, for aircrew and support personnel. As a component of ADF AIP, FIHA contains that information which aircrew will require access to both during flight planning and in flight. It is produced in a bound A5 format suitable for both cockpit and desktop use.

4.2 The rules of the air and air traffic control procedures are, to the extent practicable, incorporated into the main text of FIHA in plain language.

#### 4.3 Rules of Interpretation.

- a. 'must' is used in the imperative sense. Use of other commonly used imperatives such as 'shall', 'is to' or 'will' should not occur.
- b. 'shall' is analogous to the word must.
- c. 'may' is used in the permissive sense to state authority or permission to do the act described, and the words 'no person may...' or 'a person may not' mean that no person is required, authorised or permitted to do the act described.
- d. 'should' is used to imply an act or process identified for inclusion in a desired outcome is complied with, unless sound reasoning may determine otherwise.

4.4 Various requirements of FIHA may be over-riden by appropriately authorised orders and instructions by commanders.

4.5 **Heading Prefixes.** The heading prefixes ADF, ARMY, RAAF and RAN are added to sections, paragraphs and notes to identify where ADF/ARMY/RAAF/RAN aeronautical procedures differ from Australian civil aviation rules of the air. Minor textual differences are not identified. The term ADF identifies procedures applicable to all three Services. Heading prefixes and their associated subjects are listed in the Index.

## 5. ORDERING PUBLICATIONS AND AMENDMENT SERVICES

5.1 Publications can be obtained via Unit PUBSO by sending an email to [ais.af@defence.gov.au](mailto:ais.af@defence.gov.au). Details should include:

- a. User code (if known)
- b. Contact name
- c. Contact details
- d. Delivery address
- e. Product requested
- f. Quantity
- g. Date required

5.2 Verbal product orders will be accepted under exceptional circumstances by calling the AIS-AF Distribution Coordinator on +61 3 8531 6667.

5.3 Requests for amendments to procedures contained within FIHA are to be forwarded to the AIS-AF Air Liaison Officer through the originator's Wing Aviation Safety Officer (WASO) or equivalent. Requests for amendment should be submitted on a Publication Improvement Report and Reply form (AO011), available via Web Forms at <http://intranet.defence.gov.au>. The originating authority must ensure that all necessary information has been included and is correct in detail.

5.4 **Customer Change of Address.** All customers shall promptly advise AIS-AF of any change of address.

5.5 Mail returned "Address Unknown" suspends the address record of the subscriber, and no further mail will be forwarded until advice is received of an address change.

## 6. NOTIFICATION TO USERS OF AMENDMENTS

6.1 Product is amended by NOTAM and Aircservices AIP SUP, and is produced in accordance with the AIS-AF Production Schedule available on the AIS-AF WEBSITE (DRN only).

6.2 Any rescheduling of the above will be notified via AIB, and/or, in certain circumstances, by NOTAM.

6.3 Significant changes are indicated by a vertical black line (change bar) and deletions have a "D" added to the vertical line. Amendments to Table of Contents or Index are not identified by change bars.

## 7. QUERIES ABOUT DOCUMENTATION

7.1 Contact with AIS-AF is generally to be via Unit AIO/PUBSO/NAVO during working hours (0800 - 1630h AEST, MON-FRI), to the following appointments:

- |                     |                          |     |                 |
|---------------------|--------------------------|-----|-----------------|
| a. Distribution     | Distribution Coordinator | ☎   | +61 3 8531 6667 |
| b. Technical advice | Air Liaison Officer      | ☎   | +61 3 8531 6362 |
|                     |                          | MOB | +61 412 814 225 |

7.2 Written feedback can be submitted via email to [ais.af@defence.gov.au](mailto:ais.af@defence.gov.au). or using the online General Customer Feedback survey available on the AIS-AF website (DRN only).

7.3 All e-mail requests are to be forwarded to [ais.af@defence.gov.au](mailto:ais.af@defence.gov.au) and marked for the attention of the relevant appointment.

7.4 All urgent after-hours requests are to be directed to the duty officer +61 412 814 225. As AIS-AF does not maintain a formal after-hours capability, the majority of requests will be dealt with on the next working day. Urgent operational matters will be dealt with in as timely a manner as possible.

## 8. NON STANDARD PRODUCT REQUESTS

8.1 All requests for products outside the published AIS-AF Production and Delivery Schedule should be discussed with the AIS-AF Air Liaison Officer. This may result in a recommendation to submit a formal request via e-mail [ais.af@defence.gov.au](mailto:ais.af@defence.gov.au). Please ensure sufficient lead time (minimum 6 to 8 weeks) is allowed for customised AI products to be designed and published.

### GEN 0.2 RECORD OF AMENDMENTS

1. FIHA consists only of a complete book, therefore no record of amendments is required.

### GEN 0.3 RECORD OF Airservices Australia AIP SUPPLEMENTS

1. This section from Airservices Australia AIP not applicable to ADF.

#### 2. DEFENCE AERODROMES NOT CERTIFIED OR REGISTERED:

The following applies to non-certified and unregistered Defence aerodromes:

- a. No active obstacle management;
- b. May not be subject to regular technical inspections;
- c. Do not receive a regular aerodrome NOTAM service. Refer to Head Office NOTAMs for updates on Instrument Flight Procedures.
- d. Prior to commencing a flight, a pilot or operator MUST contact the Aerodrome Operator or Responsible Authority to check currency of aerodrome information.
- e. Additional information is included in the Notes section of the Instrument Flight Procedures chart.
- f. Instrument Flight Procedures are designed to ICAO PANSOPS and CASA MOS Part 173 standards but are not compliant with airfield survey data quality requirements. An additional 360FT is added to Instrument Approach safety heights to account for unknown vertical obstructions. It is the responsibility of the pilot to determine suitability of the facility and to avoid obstacles in the Visual Segment of the procedure below the minimum descent altitude.
- g. Instrument Flight Procedures for non-certified aerodromes will permit flight to a promulgated minima in Instrument Meteorological Conditions. Flight below circling height is to be IAW relevant OIP.

### GEN 0.4 CHECKLIST OF PAGES

1. FIHA consists only of a complete book, therefore no checklist of pages is required.

### GEN 0.5 LIST OF HAND AMENDMENTS

1. FIHA consists only of a complete book, therefore no hand amendments are required.

## GEN 0.6 TABLE OF CONTENTS

<b>GEN 0.1 PREFACE</b> .....	<b>GEN 0 - 1</b>
<b>GEN 0.2 RECORD OF AMENDMENTS</b> .....	<b>GEN 0 - 3</b>
<b>GEN 0.3 RECORD OF AIRSERVICES AUSTRALIA AIP SUPPLEMENTS</b> .....	<b>GEN 0 - 3</b>
<b>GEN 0.4 CHECKLIST OF PAGES</b> .....	<b>GEN 0 - 3</b>
<b>GEN 0.5 LIST OF HAND AMENDMENTS</b> .....	<b>GEN 0 - 3</b>
<b>GEN 0.6 TABLE OF CONTENTS</b> .....	<b>GEN 0 - 4</b>
<b>ENR 1.1 GENERAL RULES</b> .....	<b>ENR 1.1 - 1</b>
GENERAL RULES OF THE AIR .....	ENR 1.1 - 1
ADF - Minimum Safe Heights .....	ENR 1.1 - 1
ADF - Low Flying/Terrain Flight .....	ENR 1.1 - 1
ADF - Aerobatics .....	ENR 1.1 - 1
ADF - Negligent or Reckless Operation of Aircraft .....	ENR 1.1 - 2
ADF - Rules of the Air .....	ENR 1.1 - 2
ADF - Surface Movement of Aircraft .....	ENR 1.1 - 3
ADF - Dropping Objects .....	ENR 1.1 - 3
ADF - Pick Up Objects In-flight .....	ENR 1.1 - 3
ADF - Parachute Descents .....	ENR 1.1 - 3
ADF - Towing Objects .....	ENR 1.1 - 3
ADF - Aircraft Lighting .....	ENR 1.1 - 3
ARMY - Aircraft Lighting .....	ENR 1.1 - 4
OPERATIONS IN CONTROLLED AIRSPACE .....	ENR 1.1 - 4
Separation .....	ENR 1.1 - 4
Air Traffic Control Clearances and Instructions .....	ENR 1.1 - 4
Ground Movement .....	ENR 1.1 - 7
Take-Off .....	ENR 1.1 - 8
Visual Departure - IFR Flights .....	ENR 1.1 - 9
VFR Departure by an Aircraft Planned IFR .....	ENR 1.1 - 9
After Take-Off .....	ENR 1.1 - 10
VFR Climb and Descent - IFR Flights .....	ENR 1.1 - 10
VFR-On-Top - IFR Flights .....	ENR 1.1 - 11
En Route .....	ENR 1.1 - 12
Descent and Approach .....	ENR 1.1 - 13
Landing .....	ENR 1.1 - 16
Circuit Operations .....	ENR 1.1 - 19
Go Around and Missed Approach Procedure in VMC .....	ENR 1.1 - 20
Taxiing After Landing .....	ENR 1.1 - 20
OPERATIONS IN CLASS E AIRSPACE .....	ENR 1.1 - 21
ATC Traffic Services .....	ENR 1.1 - 21
VFR Flights in Class E Airspace .....	ENR 1.1 - 21
NAVIGATION REQUIREMENTS .....	ENR 1.1 - 21
Flight Under the IFR .....	ENR 1.1 - 21
Flight Under the VFR .....	ENR 1.1 - 22
Time .....	ENR 1.1 - 22
Track Keeping .....	ENR 1.1 - 22
Position Fixing .....	ENR 1.1 - 23
Aircraft Deviations in Controlled Airspace - Advice to ATC .....	ENR 1.1 - 23
Long Over-Water Flights .....	ENR 1.1 - 23
GNSS - Operations Without RAIM .....	ENR 1.1 - 23
AIR ROUTE SPECIFICATIONS .....	ENR 1.1 - 24
RADIO COMMUNICATION AND NAVIGATION REQUIREMENTS .....	ENR 1.1 - 24
Summary of Report and Broadcast Requirements .....	ENR 1.1 - 24
Inoperative Radio and No Radio Procedures .....	ENR 1.1 - 29
GNSS Reporting Requirements and Procedures .....	ENR 1.1 - 30

LAND AND HOLD SHORT OPERATIONS (LAHSO) .....	ENR 1.1 - 31
Introduction .....	ENR 1.1 - 31
Locations Where LAHSO are Used .....	ENR 1.1 - 31
A Dependent Procedure .....	ENR 1.1 - 31
Participation .....	ENR 1.1 - 31
Conditions for LAHSO .....	ENR 1.1 - 32
Pilot Advice of LAHSO Approval .....	ENR 1.1 - 32
ATIS Broadcast .....	ENR 1.1 - 33
Directed Traffic Information .....	ENR 1.1 - 33
Readback Requirements .....	ENR 1.1 - 33
Landing Distance Assessments .....	ENR 1.1 - 33
Go Around During LAHSO .....	ENR 1.1 - 33
VERTICAL SEPARATION IN THE AUSTRALIAN FIR .....	ENR 1.1 - 34
Reduced Vertical Separation Minimum (RVSM) .....	ENR 1.1 - 34
RVSM Operations .....	ENR 1.1 - 34
Operational Procedures Before Entering the RVSM Flight Level Band - RVSM Approved Aircraft .....	ENR 1.1 - 34
Operational Procedures After Entering the RVSM Flight Level Band - RVSM Approved Aircraft - .....	ENR 1.1 - 35
ATC Responsibilities .....	ENR 1.1 - 36
Weather and Wake Turbulence, and System Alerts .....	ENR 1.1 - 36
Flight Level Deviation Reporting .....	ENR 1.1 - 36
OPERATIONS IN CLASS G AIRSPACE .....	ENR 1.1 - 37
Communications .....	ENR 1.1 - 37
Circuit Information .....	ENR 1.1 - 39
Separation Minima for Take-off .....	ENR 1.1 - 40
Circuit Height .....	ENR 1.1 - 40
Taxiing .....	ENR 1.1 - 40
Departure Information .....	ENR 1.1 - 41
Climb and Cruise Procedures .....	ENR 1.1 - 41
Position Reports .....	ENR 1.1 - 42
Descent from Controlled Airspace .....	ENR 1.1 - 42
Arrival Information .....	ENR 1.1 - 42
Landing Manoeuvres .....	ENR 1.1 - 42
Circuit Entry .....	ENR 1.1 - 43
Straight-in Approach .....	ENR 1.1 - 45
Joining on Base .....	ENR 1.1 - 45
Military Initial and Pitch Circuit Procedures .....	ENR 1.1 - 47
Separation Minima for Landing .....	ENR 1.1 - 48
The Traffic Mix and Other Hazards at Non-Controlled Aerodromes .....	ENR 1.1 - 48
OPERATIONAL REQUIREMENTS - GENERAL .....	ENR 1.1 - 48
Taxiing After Landing .....	ENR 1.1 - 48
SARWATCH .....	ENR 1.1 - 48
Radio Telephony Requirements Outside Controlled Airspace .....	ENR 1.1 - 49
Diversion to an Alternate Aerodrome .....	ENR 1.1 - 49
Operating Requirements for Transponders .....	ENR 1.1 - 50
Operating Requirements for ADS-B Transmitters .....	ENR 1.1 - 50
Alternate Aerodromes .....	ENR 1.1 - 50
Suitability of Aerodromes .....	ENR 1.1 - 54
Fuel Requirements .....	ENR 1.1 - 55
Information by Pilots .....	ENR 1.1 - 55
Flights Over Water .....	ENR 1.1 - 56
Procedures for Ground Operation of Turbo-Jet Aircraft .....	ENR 1.1 - 56
Clearances - Pilot Responsibility .....	ENR 1.1 - 56
Special Requirements .....	ENR 1.1 - 57
Helicopter Operations - At Aerodromes and in Helicopter Access Corridors and Lanes .....	ENR 1.1 - 59
PROCEDURES WHEN ATS TEMPORARILY NOT AVAILABLE .....	ENR 1.1 - 61

MANDATORY BROADCAST PROCEDURES (ATS TEMPORARILY NOT AVAILABLE) .....	ENR 1.1 - 63
ADF - UNLIT MILITARY AIRCRAFT OPERATIONS .....	ENR 1.1 - 63
Use of Night Vision Goggles .....	ENR 1.1 - 63
RAAF - MARITIME SURVEILLANCE FLIGHTS .....	ENR 1.1 - 64
AP-3C Orion and P-8A Poseidon Operations .....	ENR 1.1 - 64
RAAF - MLJ OPERATIONS .....	ENR 1.1 - 65
Operational Information .....	ENR 1.1 - 65
Notification of Routes .....	ENR 1.1 - 65
ADF - FORMATION FLIGHTS .....	ENR 1.1 - 65
Military Formation Procedures .....	ENR 1.1 - 65
Transponder operation .....	ENR 1.1 - 66
Separation with other aircraft .....	ENR 1.1 - 66
Formation departures .....	ENR 1.1 - 67
Speed control .....	ENR 1.1 - 67
In-trail formation procedures .....	ENR 1.1 - 67
Snake Climb procedures .....	ENR 1.1 - 68
Formation touch and go landing .....	ENR 1.1 - 68
ADF - SPECIAL REQUIREMENTS FLIGHTS .....	ENR 1.1 - 68
Notification Requirements and Procedures .....	ENR 1.1 - 68
ADF - RECALLING OF MILITARY AIRCRAFT .....	ENR 1.1 - 69
RAAF - OPERATIONS FROM OPERATIONAL READINESS PLATFORMS .....	ENR 1.1 - 69
ADF - OPERATIONAL CONTROL .....	ENR 1.1 - 69
RAAF - AIR-TO-AIR REFUELLING .....	ENR 1.1 - 69
Purpose .....	ENR 1.1 - 69
Definitions .....	ENR 1.1 - 69
General .....	ENR 1.1 - 70
Track Requirements .....	ENR 1.1 - 70
Anchor Requirements .....	ENR 1.1 - 70
AAR Track and Anchor Pattern Establishment .....	ENR 1.1 - 71
Flight Planning .....	ENR 1.1 - 72
Operations .....	ENR 1.1 - 72
RAAF - AIRBORNE EARLY WARNING AND CONTROL (AEW&C) OPERATIONS .....	ENR 1.1 - 76
Purpose .....	ENR 1.1 - 76
Definitions .....	ENR 1.1 - 76
General .....	ENR 1.1 - 76
AEW&C Orbit Requirements .....	ENR 1.1 - 76
Permanent Orbit Pattern Establishment .....	ENR 1.1 - 77
Operations .....	ENR 1.1 - 77
Flight Planning .....	ENR 1.1 - 78
<b>ENR 1.2 THE VISUAL FLIGHT RULES .....</b>	<b>ENR 1.2 - 1</b>
FLIGHT RULES .....	ENR 1.2 - 1
The Visual Flight Rules (VFR) .....	ENR 1.2 - 1
Special VFR .....	ENR 1.2 - 1
VISUAL METEOROLOGICAL CONDITIONS (VMC) - TAKE-OFF, EN ROUTE AND LANDING .....	ENR 1.2 - 2
<b>ENR 1.3 THE INSTRUMENT FLIGHT RULES .....</b>	<b>ENR 1.3 - 1</b>
THE INSTRUMENT FLIGHT RULES (IFR) .....	ENR 1.3 - 1
FLIGHT RULES NOMINATION .....	ENR 1.3 - 1

<b>ENR 1.4 ATS AIRSPACE CLASSIFICATION .....</b>	<b>ENR 1.4 - 1</b>
CONTROLLED AIRSPACE .....	ENR 1.4 - 1
General .....	ENR 1.4 - 1
Control Areas .....	ENR 1.4 - 4
Control Zone .....	ENR 1.4 - 4
Airspace Reservation .....	ENR 1.4 - 4
Authorisation of Civil Flights in Military Airspace .....	ENR 1.4 - 4
Release of Control Areas, Control Zones, Restricted or Military Operating Areas .....	ENR 1.4 - 5
Deactivation of Control Zones or Special Use Airspace .....	ENR 1.4 - 5
PROVISION OF SEPARATION IN CONTROLLED AIRSPACE .....	ENR 1.4 - 5
General .....	ENR 1.4 - 5
Special Provisions .....	ENR 1.4 - 6
Wake Turbulence Separation .....	ENR 1.4 - 6
ADF - Military CTA .....	ENR 1.4 - 7
ADF - Military Training Areas .....	ENR 1.4 - 7
ADF - Pilot responsibility for separation (PRS) .....	ENR 1.4 - 8
CLASS G AIRSPACE .....	ENR 1.4 - 8
Flight Information Areas .....	ENR 1.4 - 8
Broadcast Areas .....	ENR 1.4 - 9
CLASSES OF AIRSPACE - SERVICES AND REQUIREMENTS .....	ENR 1.4 - 9
LANES OF ENTRY (LOE) .....	ENR 1.4 - 11
REGULATION OF FLIGHT - ASSESSMENT OF PRIORITIES .....	ENR 1.4 - 11
<b>ENR 1.5 HOLDING, APPROACH AND DEPARTURE PROCEDURES .....</b>	<b>ENR 1.5 - 1</b>
HOLDING AND INSTRUMENT APPROACH TO LAND (IAL) PROCEDURES .....	ENR 1.5 - 1
General .....	ENR 1.5 - 1
Aircraft Performance Category .....	ENR 1.5 - 1
Helicopters .....	ENR 1.5 - 1
Minimum Route Altitudes .....	ENR 1.5 - 1
Procedure Entry .....	ENR 1.5 - 2
Circling Approaches and Visual Circling .....	ENR 1.5 - 2
Visual Manoeuvring (non-circling) Subsequent to Non-precision Approaches (NPA) and Approaches with Vertical Guidance (APV) .....	ENR 1.5 - 3
Visual Approach Area - Helicopter .....	ENR 1.5 - 4
Missed Approach - Standard Procedures .....	ENR 1.5 - 6
Missed Approach Tracking .....	ENR 1.5 - 6
Missed Approach Requirements - GNSS .....	ENR 1.5 - 7
Missed Approach - Helicopter Procedures .....	ENR 1.5 - 7
Visual Segments .....	ENR 1.5 - 7
Visual Approach Requirements for IFR flights .....	ENR 1.5 - 7
Handling Speeds .....	ENR 1.5 - 9
Speed Restrictions .....	ENR 1.5 - 9
Obstacle Clearance Altitude .....	ENR 1.5 - 10
Aerodrome Operating Minima (AOM) .....	ENR 1.5 - 10
Descent Gradients .....	ENR 1.5 - 11
Descent .....	ENR 1.5 - 11
Wind Effect .....	ENR 1.5 - 11
Bank Angle .....	ENR 1.5 - 11
APPROACH PROCEDURES .....	ENR 1.5 - 12
Operations On Parallel Runways At Class C Aerodromes .....	ENR 1.5 - 12
Use Of Navigation Aids .....	ENR 1.5 - 12
Minimum Sector Altitude .....	ENR 1.5 - 12
Approach Design Concept .....	ENR 1.5 - 12
Procedure Entry .....	ENR 1.5 - 13
Approach Segments and Fixes .....	ENR 1.5 - 14
Missed Approach Procedure .....	ENR 1.5 - 15
Reversal Procedures .....	ENR 1.5 - 15
DME Arcs .....	ENR 1.5 - 16

ADF - Procedure Containment .....	ENR 1.5 - 17
HOLDING PROCEDURES .....	ENR 1.5 - 17
General .....	ENR 1.5 - 17
Holding in Controlled Airspace .....	ENR 1.5 - 17
Limitations .....	ENR 1.5 - 17
Entry Into the Holding Pattern .....	ENR 1.5 - 18
Standard Holding Pattern .....	ENR 1.5 - 19
DME limit .....	ENR 1.5 - 19
Shortening .....	ENR 1.5 - 20
Descent in Holding Pattern .....	ENR 1.5 - 20
AERODROME METEOROLOGICAL MINIMA .....	ENR 1.5 - 20
Ceiling and Visibility Minima .....	ENR 1.5 - 20
Runway Visual Range and Runway Visibility .....	ENR 1.5 - 20
ADF - IFR Take-off and Landing Minima .....	ENR 1.5 - 20
Correction of Instrument Procedure Minima for non-standard temperatures. ....	ENR 1.5 - 20
APPLICATION OF AERODROME METEOROLOGICAL MINIMA .....	ENR 1.5 - 21
Pilot Responsibilities .....	ENR 1.5 - 21
ATC Assessment .....	ENR 1.5 - 21
QNH Sources .....	ENR 1.5 - 21
ALTERNATE WEATHER MINIMA .....	ENR 1.5 - 21
IFR Flights .....	ENR 1.5 - 21
Special Alternate Weather Minima .....	ENR 1.5 - 21
PRECISION APPROACH OPERATIONS .....	ENR 1.5 - 22
General .....	ENR 1.5 - 22
Failures .....	ENR 1.5 - 22
Altimeter Checks and Flight Tolerances .....	ENR 1.5 - 23
Protection of GLS Critical and Sensitive Areas .....	ENR 1.5 - 23
STANDARD INSTRUMENT DEPARTURES .....	ENR 1.5 - 23
General .....	ENR 1.5 - 23
SID Procedures .....	ENR 1.5 - 23
NOISE ABATEMENT PROCEDURES .....	ENR 1.5 - 25
Application .....	ENR 1.5 - 25
Curfews .....	ENR 1.5 - 26
STANDARD INSTRUMENT ARRIVALS (STARS) .....	ENR 1.5 - 26
General .....	ENR 1.5 - 26
STAR Procedures .....	ENR 1.5 - 26
DME OR GNSS ARRIVAL PROCEDURES .....	ENR 1.5 - 27
General .....	ENR 1.5 - 27
Operations in Controlled Airspace .....	ENR 1.5 - 27
ADF - DME/GNSS Arrival Chart Format .....	ENR 1.5 - 27
SIGNALS FOR THE CONTROL OF AERODROME TRAFFIC .....	ENR 1.5 - 28
Light Signals to Aircraft .....	ENR 1.5 - 28
Light Signals to Vehicles and Pedestrians .....	ENR 1.5 - 28
Ground Signals to Aircraft .....	ENR 1.5 - 29
<b>ENR 1.6 ATS SURVEILLANCE SERVICES AND PROCEDURES .....</b>	<b>ENR 1.6 - 1</b>
RADIO COMMUNICATIONS PROCEDURES .....	ENR 1.6 - 1
IDENTIFICATION PROCEDURES .....	ENR 1.6 - 1
VECTORING PROCEDURES .....	ENR 1.6 - 1
ATC RESPONSIBILITIES IN RESPECT OF UNIDENTIFIED AIRCRAFT .....	ENR 1.6 - 3
SPEED CONTROL (ARRIVING AIRCRAFT) .....	ENR 1.6 - 3
EMERGENCY PROCEDURES .....	ENR 1.6 - 3
General .....	ENR 1.6 - 3
Radio Failure Procedure .....	ENR 1.6 - 3
ATS Surveillance System - Failure Procedure. ....	ENR 1.6 - 4
SSR Emergency Codes .....	ENR 1.6 - 4
ADS-B Emergency Codes .....	ENR 1.6 - 4



AIRCRAFT TRANSPONDER .....	ENR 1.6 - 4
Operation of SSR Transponders .....	ENR 1.6 - 4
ADF - ATS SURVEILLANCE SYSTEM CLOUD BREAK PROCEDURE .....	ENR 1.6 - 6
Procedures for Military Aircraft .....	ENR 1.6 - 6
When Procedures Shall Not be Used .....	ENR 1.6 - 6
<b>ENR 1.7 ALTIMETER SETTING PROCEDURES .....</b>	<b>ENR 1.7 - 1</b>
PRE-FLIGHT ALTIMETER CHECK .....	ENR 1.7 - 1
General .....	ENR 1.7 - 1
IFR Altimeters .....	ENR 1.7 - 1
VFR Altimeters .....	ENR 1.7 - 1
Accurate QNH and Site Elevation .....	ENR 1.7 - 1
BASIC ALTIMETER SETTING PROCEDURES .....	ENR 1.7 - 2
Transition Altitude, Transition Layer and Transition Level .....	ENR 1.7 - 2
CRUISING LEVELS .....	ENR 1.7 - 3
Selection of Levels .....	ENR 1.7 - 3
Block Levels .....	ENR 1.7 - 4
ADF - Assignment of Levels to Military Formations .....	ENR 1.7 - 4
CHANGE OF LEVELS .....	ENR 1.7 - 4
ATC Approval Required .....	ENR 1.7 - 4
ATC Approval Not Required .....	ENR 1.7 - 5
TABLES OF CRUISING LEVELS (NORTH OF 80°S) .....	ENR 1.7 - 5
TABLES OF CRUISING LEVELS (SOUTH OF 80°S) .....	ENR 1.7 - 6
<b>ENR 1.8 REGIONAL SUPPLEMENTARY PROCEDURES .....</b>	<b>ENR 1.8 - 1</b>
<b>ENR 1.9 AIR TRAFFIC FLOW MANAGEMENT .....</b>	<b>ENR 1.9 - 1</b>
FLOW MANAGEMENT STAGES .....	ENR 1.9 - 1
STRATEGIC - SCHEDULE COORDINATION .....	ENR 1.9 - 1
PRE TACTICAL – GROUND DELAY PROGRAM .....	ENR 1.9 - 1
TACTICAL .....	ENR 1.9 - 3
Aircraft Sequencing Near ATFM Airports .....	ENR 1.9 - 3
<b>ENR 1.10 FLIGHT PLANNING .....</b>	<b>ENR 1.10 - 1</b>
FLIGHT PLAN PREPARATION .....	ENR 1.10 - 1
Forecasts .....	ENR 1.10 - 1
GNSS Prediction Analysis - Flight in Oceanic and Remote Areas .....	ENR 1.10 - 2
FLIGHT NOTIFICATION .....	ENR 1.10 - 2
ADF - Submission of Flight Details .....	ENR 1.10 - 4
FLIGHT NOTIFICATION/NOTE CONTENTS .....	ENR 1.10 - 4
Forms .....	ENR 1.10 - 4
Flight Rules .....	ENR 1.10 - 4
PBN Notification .....	ENR 1.10 - 4
Military Flights .....	ENR 1.10 - 5
General .....	ENR 1.10 - 5
Location Data .....	ENR 1.10 - 5
FLIGHT NOTIFICATION AMENDMENT .....	ENR 1.10 - 6
CARRIAGE OF FLIGHT DOCUMENTATION .....	ENR 1.10 - 6
ADF - SARTIME/NOCOM PROCEDURES .....	ENR 1.10 - 7
<b>ENR 1.11 ADDRESSING OF FLIGHT PLAN MESSAGES .....</b>	<b>ENR 1.11 - 1</b>
<b>ENR 1.12 INTERCEPTION OF CIVIL AIRCRAFT .....</b>	<b>ENR 1.12 - 1</b>
ACTION BY INTERCEPTED AIRCRAFT .....	ENR 1.12 - 1
VISUAL SIGNALS FOR USE IN THE EVENT OF INTERCEPTION .....	ENR 1.12 - 2
PROCEDURES FOR AIRCRAFT OPERATING IN	
AN AIR DEFENCE IDENTIFICATION ZONE .....	ENR 1.12 - 4
General .....	ENR 1.12 - 4
Special Requirements .....	ENR 1.12 - 4
Non-Compliance .....	ENR 1.12 - 5
Diversion of Aircraft for Defence Operations .....	ENR 1.12 - 5

INTERCEPTION PROCEDURES .....	ENR 1.12 - 5
Phase I .....	ENR 1.12 - 5
Phase II .....	ENR 1.12 - 5
Phase III .....	ENR 1.12 - 5
Guidance of an intercepted aircraft .....	ENR 1.12 - 6
<b>ENR 1.13 UNLAWFUL INTERFERENCE .....</b>	<b>ENR 1.13 - 1</b>
PILOT ACTIONS .....	ENR 1.13 - 1
<b>ENR 1.14 AIR TRAFFIC INCIDENTS .....</b>	<b>ENR 1.14 - 1</b>
<b>ENR 2.1 FIR, UIR, TMA .....</b>	<b>ENR 2 - 1</b>
<b>ENR 2.2 OTHER REGULATED AIRSPACE .....</b>	<b>ENR 2 - 1</b>
OPERATIONS IN OCEANIC CONTROL AREA (OCA) .....	ENR 2 - 1
Clearance Requirements .....	ENR 2 - 1
Mach Number Technique .....	ENR 2 - 1
SPECIAL PROCEDURES FOR IN-FLIGHT CONTINGENCIES	
IN OCEANIC AIRSPACE .....	ENR 2 - 1
Introduction .....	ENR 2 - 1
General procedures .....	ENR 2 - 2
Actions to be taken once offset from track .....	ENR 2 - 2
Weather Deviations .....	ENR 2 - 3
STRATEGIC LATERAL OFFSET PROCEDURES (SLOP) IN OCA .....	ENR 2 - 4
USE OF GNSS IN OCEANIC AND REMOTE AREAS .....	ENR 2 - 5
OPERATIONS IN OCEANIC AIRSPACE REQUIRING	
PERFORMANCE-BASED COMMUNICATION AND	
SURVEILLANCE (PBCS) AUTHORISATION .....	ENR 2 - 5
<b>ENR 3.1 LOWER ATS ROUTES .....</b>	<b>ENR 3 - 1</b>
<b>ENR 3.2 UPPER ATS ROUTES .....</b>	<b>ENR 3 - 1</b>
<b>ENR 3.3 AREA NAVIGATION ROUTES .....</b>	<b>ENR 3 - 1</b>
<b>ENR 3.4 HELICOPTER ROUTES .....</b>	<b>ENR 3 - 1</b>
<b>ENR 3.5 OTHER ROUTES .....</b>	<b>ENR 3 - 1</b>
<b>ENR 3.6 EN ROUTE HOLDING .....</b>	<b>ENR 3 - 1</b>
<b>ENR 4.1 RADIO NAVIGATION AIDS - EN ROUTE .....</b>	<b>ENR 4 - 1</b>
<b>ENR 4.2 SPECIAL NAVIGATION SYSTEMS .....</b>	<b>ENR 4 - 1</b>
<b>ENR 4.3 GLOBAL NAVIGATION SATELLITE SYSTEM (GNSS) .....</b>	<b>ENR 4 - 1</b>
<b>ENR 4.4 NAME-CODE DESIGNATORS FOR SIGNIFICANT POINTS .....</b>	<b>ENR 4 - 1</b>
<b>ENR 4.5 AERONAUTICAL GROUND LIGHTS - EN ROUTE .....</b>	<b>ENR 4 - 1</b>
<b>ENR 5. NAVIGATION WARNINGS .....</b>	<b>ENR 5 - 1</b>
<b>ENR 5.1 PROHIBITED, RESTRICTED, DANGER AND</b>	
<b>MILITARY OPERATING AREAS .....</b>	<b>ENR 5 - 1</b>
GENERAL .....	ENR 5 - 1
FLIGHT WITHIN PRD AND MOA .....	ENR 5 - 1

<b>ENR 5.2 MILITARY EXERCISE AND TRAINING AREAS AND AIR DEFENCE IDENTIFICATION ZONE (ADIZ)</b> .....	<b>ENR 5 - 3</b>
MILITARY SENSITIVE AREAS .....	ENR 5 - 3
Brisbane FIR .....	ENR 5 - 3
Melbourne FIR .....	ENR 5 - 7
Permanent Drilling Rigs .....	ENR 5 - 8
MILITARY AAR AND AEW&C AIRSPACE .....	ENR 5 - 8
General .....	ENR 5 - 8
Explanation of terms .....	ENR 5 - 9
Amberley AAR and AEW&C airspace .....	ENR 5 - 10
Darwin AAR and AEW&C airspace .....	ENR 5 - 16
EAXA AAR and AEW&C airspace .....	ENR 5 - 18
Edinburgh AAR and AEW&C airspace .....	ENR 5 - 19
Tindal AAR and AEW&C airspace .....	ENR 5 - 20
Townsville AAR and AEW&C airspace .....	ENR 5 - 23
Williamtown AAR and AEW&C airspace .....	ENR 5 - 25
MILITARY AAR AND AEW&C AIRSPACE ANCHOR WAYPOINTS .....	ENR 5 - 32
MILITARY AAR TRACK WAYPOINTS .....	ENR 5 - 36
MILITARY AAR AND AEW&C PATTERNS .....	ENR 5 - 37
REFUELLING TRACKS .....	ENR 5 - 40
PROCEDURES FOR AIRCRAFT OPERATING IN AN AIR DEFENCE IDENTIFICATION ZONE .....	ENR 5 - 45
<b>ENR 5.3 OTHER ACTIVITIES OF A DANGEROUS NATURE AND OTHER POTENTIAL HAZARDS</b> .....	<b>ENR 5 - 47</b>
<b>ENR 5.4 AIR NAVIGATION OBSTACLES - EN ROUTE</b> .....	<b>ENR 5 - 47</b>
Man-made Obstacles Greater Than 360 Feet .....	ENR 5 - 47
Marking of Power Lines and Other Overhead Cables .....	ENR 5 - 47
NVIS AND OBSTACLE LIGHTING .....	ENR 5 - 47
<b>ENR 5.5 AERIAL SPORT AND RECREATIONAL ACTIVITIES</b> .....	<b>ENR 5 - 47</b>
GLIDING OPERATIONS .....	ENR 5 - 47
General .....	ENR 5 - 47
Operations at Certified Aerodromes .....	ENR 5 - 47
PARACHUTING OPERATIONS .....	ENR 5 - 48
General .....	ENR 5 - 48
Conflicting Traffic .....	ENR 5 - 48
Additional Requirements in Controlled Airspace .....	ENR 5 - 48
Additional Requirements for Operations Above 10,000FT AMSL .....	ENR 5 - 48
BALLOON OPERATIONS .....	ENR 5 - 49
ADF - The RAAF Balloon Flight .....	ENR 5 - 49
General .....	ENR 5 - 49
Operations in the Vicinity of Aerodromes .....	ENR 5 - 49
Meteorological Conditions .....	ENR 5 - 49
Night Balloon Operations .....	ENR 5 - 49
Operations in Controlled Airspace .....	ENR 5 - 50
<b>ENR 5.6 BIRD MIGRATION AND AREAS WITH SENSITIVE FAUNA</b> .....	<b>ENR 5 - 10</b>

<b>AD 1.1 AERODROMES/HELIPORTS AVAILABILITY AND CONDITIONS OF USE .....</b>	<b>AD 1 - 1</b>
GENERAL CONDITIONS .....	AD 1 - 1
ADF - MILITARY AIR BASES .....	AD 1 - 1
LOW VISIBILITY OPERATIONS .....	AD 1 - 3
Approval Required .....	AD 1 - 3
Low Visibility Procedures .....	AD 1 - 3
Protection of ILS Critical and Sensitive Areas .....	AD 1 - 4
<b>AERODROME MARKERS AND MARKINGS .....</b>	<b>AD 1 - 5</b>
Boundary Markers .....	AD 1 - 5
Runway Markers .....	AD 1 - 6
Unserviceable Areas .....	AD 1 - 6
Restricted Operations .....	AD 1 - 7
Runway Markings .....	AD 1 - 7
Runway Strip Markings .....	AD 1 - 12
Stopway Markings .....	AD 1 - 12
Distance To Run Markers (DTRM) .....	AD 1 - 13
Hookcable Markers .....	AD 1 - 15
Taxi Guide-line Markings .....	AD 1 - 16
Holding Bay Markings .....	AD 1 - 18
Obstacle Marking .....	AD 1 - 20
Aerodrome Information Signs .....	AD 1 - 21
Aerodrome Mandatory Instruction Signs .....	AD 1 - 22
<b>LIGHTING .....</b>	<b>AD 1 - 23</b>
Permanent Threshold Lighting .....	AD 1 - 23
Runway Threshold Identification Lights (RTIL) .....	AD 1 - 23
Displaced Threshold Lighting .....	AD 1 - 24
Runway Edge Lighting .....	AD 1 - 25
Runway End Lighting .....	AD 1 - 25
Runway Centreline Lighting .....	AD 1 - 26
Runway Touchdown Zone Lighting .....	AD 1 - 26
Partial Unserviceability Area Lighting .....	AD 1 - 26
Stopway Lighting .....	AD 1 - 26
ADF - Lighting of runways .....	AD 1 - 26
ADF - DTRM and HCM Lighting .....	AD 1 - 26
ADF - Aircraft Arrestor System (Net Barriers) Aiming Light .....	AD 1 - 26
ADF - Arrestor Barrier Lighting .....	AD 1 - 27
Taxiway Lighting .....	AD 1 - 27
Approach Lighting .....	AD 1 - 29
Wind Direction Indicator Lighting .....	AD 1 - 32
Aerodrome Beacons .....	AD 1 - 32
Obstacle Lighting .....	AD 1 - 32
General Aviation Aircraft Lanes of Entry .....	AD 1 - 32
Pilot Activated Lighting (PAL) .....	AD 1 - 32
Visual Guidance and Information .....	AD 1 - 33
<b>VISUAL DOCKING GUIDANCE SYSTEMS .....</b>	<b>AD 1 - 37</b>
Nose in Guidance (NIG) System .....	AD 1 - 37
Aircraft Positioning and Information System (APIS) .....	AD 1 - 38
Safegate Docking Guidance System (DGS). .....	<b>AD 1 - 39</b>
<b>PAVEMENT STRENGTH LIMITATIONS .....</b>	<b>AD 1 - 41</b>
General .....	AD 1 - 41
Information Published for Rated Pavements .....	AD 1 - 42
Determination of Pavement Strength Suitability - Rated Pavements .....	AD 1 - 42
Determination of Pavement Strength - Unrated Pavements .....	AD 1 - 45
Pavement Concessions .....	AD 1 - 45
Care of Pavements .....	AD 1 - 45
ADF - Information Published for Rated Military Pavements .....	AD 1 - 45
ADF- Load Classification Number (LCN) System .....	AD 1 - 49

ACN/PCN & LCN GRAPHS .....	AD 1 - 51
Boeing 737 BBJ .....	AD 1 - 51
Model 737-8 / -8-200 / BBJ MAX 8 .....	AD 1 - 52
C-17A Globemaster .....	AD 1 - 53
C-27 J Spartan .....	AD 1 - 55
C130 J Hercules .....	AD 1 - 56
CH-47 F Chinook .....	AD 1 - 61
E-7A Wedgetail .....	AD 1 - 62
EC-665 Tiger Armed Reconnaissance Helicopter .....	AD 1 - 63
F/A-18A Hornet .....	AD 1 - 64
F/A-18F Super Hornet .....	AD 1 - 65
F-35A JSF .....	AD 1 - 66
Falcon 7X .....	AD 1 - 67
HAWK 127 Lead In Fighter .....	AD 1 - 69
KC-30A MRTT .....	AD 1 - 70
MH-60R SEAHAWK ROMEO .....	AD 1 - 71
MRH90 HELICOPTER .....	AD 1 - 72
AP-3C Orion .....	AD 1 - 73
P-8 Poseidon .....	AD 1 - 75
<b>AD 1.2 RESCUE AND FIRE FIGHTING SERVICES AND SNOW PLAN .....</b>	<b>AD 1 - 76</b>
<b>AD 1.3 INDEX TO AERODROMES AND HELIPORTS .....</b>	<b>AD 1 - 79</b>
<b>AD 1.4 GROUPING OF AERODROMES/HELIPORTS .....</b>	<b>AD 1 - 79</b>
<b>AD 1.5 STATUS OF CERTIFICATION OF AERODROMES .....</b>	<b>AD 1 - 79</b>
<b>AD 2.1 FIHA AD2 SUPPLEMENTS .....</b>	<b>AD 2 - 1</b>
<b>AD 3 HELIPORTS .....</b>	<b>AD 3 - 1</b>
<b>INDEX .....</b>	<b>1 - 1</b>
<b>FIHA - AREA OF COVERAGE .....</b>	<b>1 - 2</b>



## ENR 1.1 GENERAL RULES

### 1. GENERAL RULES OF THE AIR

#### 1.1 ADF - Minimum Safe Heights

1.1.1 Except where necessary for taking off, landing, executing instrument approach procedures, conforming with ATC instructions, or when authorised by an appropriate authority in order to undertake a specific task, aircraft shall not be flown:

- a. over the congested areas of cities, towns or settlements, or over an open-air assembly of persons, unless at such a height as will permit, in the event of an emergency arising, a landing to be made without undue hazard to persons or property on the surface; this height shall not be less than 1000FT above the highest obstacle within a radius of 600M from the aircraft (300M in the case of a helicopter); and
- b. elsewhere than as specified above, at a height less than 500FT above obstacles or water (**ARMY** - 200FT above highest obstacles or water).

*Note 1: **RAN** - RAN aircrew operating over water must do so IAW Naval Aviation Standing Instructions - SI(NA).*

1.1.2 Exemptions of a long term or permanent nature authorised by Command Headquarters to these requirements must be published in the relevant Command Standing Instructions (SIs).

#### 1.2 ADF - Low Flying/Terrain Flight

1.2.1 Low flying is defined as flying at less than 500FT (**ARMY**- 200FT) above obstacles or water. Terrain Flight is defined in GPA GEN 2.2. Pilots may carry out low flying/terrain flight only when it is specifically briefed, authorised and flown in accordance with the relevant Command SIs, and then only in an authorised low flying/terrain flight area, over open ocean, or along an approved route on a low level/terrain flight cross-country flight. Pilots are not to be regarded as contravening the relevant Command SIs where the contravention arises from:

- a. the inevitable stress of weather;
- b. air traffic control instructions;
- c. minimum airfield circuit requirements consistent with sub-paragraphs a. and b. and constituting the least hazard to public safety within those parameters;
- d. rotary wing aircraft carrying out normal operations on designated training and operational areas; or
- e. rotary or fixed wing VTOL/STOL aircraft en route to or from an in-city/town destination when so authorised and the pilot has selected the most suitable route and altitude bearing in mind the possibility of engine failure.

1.2.2 The pilot of an aircraft towing or trailing an object is not to descend below 500FT, except in an emergency, above the highest obstruction until the towed object has been reeled in and secured, or jettisoned.

1.2.3 Exemptions of a long term or permanent nature authorised by Command Headquarters to these requirements will be published in the relevant SIs or in SI(NA) for **RAN** aircrew.

#### 1.3 ADF - Aerobatics

1.3.1 No pilot is to engage in aerobatics over populous areas or public gatherings except as approved in appropriate Command instructions. Instructions relating to flypasts and flying displays are published in:

- a. **RAN**. SI(NA);
- b. **ARMY**. SI (AVN); and
- c. **RAAF**. AC SI.

### 1.4 ADF - Negligent or Reckless Operation of Aircraft

1.4.1 An aircraft is not to be operated in a negligent or reckless manner so as to be likely to endanger life or property of others.

### 1.5 ADF - Rules of the Air

#### 1.5.1 Proximity to Other Aircraft

1.5.1.1 An aircraft is not to be operated in such proximity to other aircraft as to create a collision hazard. Flight in formation must only take place when correctly authorised.

#### 1.5.2 ADF - Right of Way

1.5.2.1 The captain of an aircraft who is required by these rules to give right of way to another aircraft is to avoid passing over or under the other, or crossing ahead, unless well clear. An aircraft is well clear if it is flown no closer than 500FT vertically or 600M (2000FT) horizontally from other aircraft.

#### 1.5.3 ADF - Overtaking

1.5.3.1 For the purpose of these rules, an "overtaking aircraft" means an aircraft that approaches another aircraft from the rear on a line forming an angle of less than 70° with the plane of symmetry of the latter, that is to say, an aircraft that is in such position with reference to another aircraft that at night would be unable to see either of the forward navigation lights of the other aircraft.

1.5.3.2 An aircraft being overtaken has the right of way and the overtaking aircraft, whether climbing, or descending or in horizontal flight, shall give right of way to the other aircraft by altering its heading to the right, and no subsequent change in the relative positions of the two aircraft shall absolve the overtaking aircraft from this obligation until it is entirely past and clear. The overtaking aircraft shall not pass by diving.

#### 1.5.4 ADF - Landing

1.5.4.1 The captain of an aircraft in flight or operating on the ground or water is to operate their aircraft so as to give way to other aircraft landing or on final approach to land.

1.5.4.2 When two or more aircraft are approaching an airfield for the purpose of landing, the aircraft at the lower altitude has the right of way, but aircraft captains are not to take advantage of this rule to cut in front of another aircraft which is on final approach to land, or to overtake that aircraft.

1.5.4.3 An aircraft captain, aware that another aircraft is compelled to land, must give way to that aircraft.

#### 1.5.5 ADF - Converging

1.5.5.1 When two aircraft are converging at approximately the same height, the aircraft captain having the other on their right must give way except that:

- a. power driven heavier-than-air aircraft must give way to airships, gliders and balloons;
- b. airships must give way to gliders and balloons;
- c. gliders must give way to balloons; and
- d. captains of power driven aircraft must give way to aircraft which are seen to be towing other aircraft or objects.

#### 1.5.6 ADF - Approaching Head-on Rule

1.5.6.1 When two aircraft are approaching head-on or approximately so, and there is danger of collision, both aircraft captains must alter heading to the right.

#### 1.5.7 ADF - Taking-off

1.5.7.1 The captain of an aircraft about to take-off must not attempt to do so until there is no apparent risk of collision with other aircraft.



### 1.6 ADF - Surface Movement of Aircraft

1.6.1 In case of danger of collision between two aircraft taxiing on the manoeuvring area of an aerodrome the following shall apply:

- a. When two aircraft are approaching head on, or approximately so, each shall stop or where practicable alter its course to the right so as to keep well clear.
- b. When two aircraft are on a converging course, the one which has the other on its right shall give way.
- c. An aircraft which is being overtaken by another aircraft shall have the right of way and the overtaking aircraft shall keep well clear of the other aircraft.

1.6.2 An aircraft taxiing on the manoeuvring area shall stop and hold at all taxi holding positions unless otherwise authorised by the aerodrome control tower.

### 1.7 ADF - Dropping Objects

1.7.1 Nothing is to be dropped from an aircraft in flight that might create a hazard to persons or property. This rule is not to prevent the authorised dropping of objects for humane reasons or for military purposes.

### 1.8 ADF - Pick Up Objects In-flight

1.8.1 Except with the prior approval of and in accordance with the conditions specified by AFHQ (HQ 16 Bde (Avn) for Army), objects must not be picked up by aircraft in flight. **RAN** - RAN helicopters conducting VERTREP/External load operations shall do so IAW ANP 3300, SQN/ship SOP and the relevant aircraft flight manual.

1.8.2 **ARMY** - Army helicopters conducting VERTREP/External load operations shall do so in accordance with AAAvn SIs, the relevant aircraft flight manual and ANP 3300/SQN/ship SOP (if applicable).

### 1.9 ADF - Parachute Descents

1.9.1 Parachute descents, other than emergency descents, must not be made unless authorised by the appropriate authority.

### 1.10 ADF - Towing Objects

1.10.1 No objects must be towed by an aircraft except in accordance with requirements prescribed by AFHQ or Navy Office as appropriate.

### 1.11 ADF - Aircraft Lighting

1.11.1 **Ground operations.** By night, aircraft operating on the movement area of an aerodrome must have lights visible to unaided observers displayed. If NVD will be used in flight, aircraft lighting visible to unaided observers must remain on until immediately prior to take off. At aerodromes being used or available for night-flying, all aircraft parked on the manoeuvring area or in close proximity thereto must be clearly illuminated, display aircraft lighting, or the area which they occupy is marked with obstruction lights visible to unaided observers.

1.11.2 **Flight operations – Single Aircraft.** Unless specified otherwise in command instruction, single aircraft operating at night, whether unaided or aided, must display position and anti-collision lighting to ensure that the aircraft is visible to unaided observers.

1.11.3 **Flight operations – Formation.** Unless specified otherwise in command instruction, all formation aircraft must display position lighting visible to unaided observers and one aircraft per formation must display an anti-collision light visible to unaided observers.

1.11.4 **Reduced visible lighting.** Aircraft may operate with reduced or no lighting visible to unaided observers:

- a. when a need exists to achieve mission objectives, and
- b. with specific flight authorisation.

1.11.5 When authorised, aircraft may operate with reduced visible lighting within the specified airspace under the following conditions:

- a. military controlled CTR/CTA/PRD – must advise ATC;
- b. PRD that are not provided with an ATS – should establish and maintain positive communications with other aircraft that may conflict;
- c. Class G airspace – should:
  - 1) make advisory broadcasts to provide awareness of the aircraft operation; and
  - 2) promulgate NOTAM or LJR with advice 'ACFT MAY DISPLAY NO EXTERNAL LGT'.

### 1.12 ARMY - Aircraft Lighting

1.12.1 **Single aircraft operations.** Army aircraft operating at night, whether unaided or aided, shall display position and anti-collision lighting to ensure that the aircraft is visible to unaided observers.

1.12.2 **Formation flight.** All aircraft shall display visible position lighting and one aircraft per formation shall display an anti-collision light.

1.12.3 Formation flight lighting requirements may be further reduced to one anti-collision light per formation when operating in:

- a. an area promulgated by NOTAM and/or ERSA for operations using 'LGT ENHANCEMENT DEVICES AND MAY DISPLAY MINIMAL EXTERNAL LGT'.

1.12.4 The minimum lighting requirements detailed in paragraphs 1.12.1, 1.12.2, and 1.12.3 may be further reduced to no visible external lighting when:

- a. operating in an operational environment, or
- b. operating in an active military restricted area, and
- c. operating IAW applicable SIs, and
- d. positive communications have been established and maintained with other aircraft that may conflict, and where applicable, approved by ATC.

## 2. OPERATIONS IN CONTROLLED AIRSPACE

### 2.1 Separation

*Note: Separation between aircraft is provided in accordance with ENR 1.4 Section 4.*

### 2.2 Air Traffic Control Clearances and Instructions

2.2.1 A pilot in command of an aircraft must not enter a control zone or a control area that is Class A, B, C, D or E airspace without ATC clearance unless it is a VFR flight entering Class E airspace.

*Note 1: An ATC clearance is valid:*

- a. for a flight wholly contained in controlled airspace – to the specified destination or clearance limit;
- b. for a flight that is partly contained in controlled airspace – to the point where the aircraft first leaves controlled airspace; or
- c. only if the flight enters controlled airspace in accordance with the clearance at or before the clearance expiry time, if issued.

*Note 2: To request access to Restricted or Military Operating Areas contact the relevant controlling or administering authority - refer ENR 5.1.*

2.2.2 A pilot must advise ATC immediately if issued a clearance with which the pilot cannot comply. If considered necessary, a pilot should request a different clearance from that issued.

2.2.3 When clearance has been issued to deviate from the cleared route the pilot must advise ATC when the deviation:

- a. is no longer required; or

- b. has been completed and the aircraft is established back on its cleared route.

2.2.4 If unable to obtain a clearance for a deviation and the pilot considers there is no safer alternative course of action:

- a. select code 7700;
- b. broadcast an urgency message specifying details of the deviation on the appropriate ATC and emergency frequencies; and
- c. repeat the urgency message at regular intervals.

*Note 1: Aircraft proceed at their own risk when entering an active Restricted or Military Operating Area without a clearance or approval.*

*Note 2: ATC will terminate control services and continue to provide flight information and alerting services.*

2.2.4.1 Pilots must obtain a clearance to re-enter controlled airspace before exiting the Restricted or Military Operating Area.

2.2.5 Except for instructions related to SID and STAR operations when ATC issues a level clearance to an aircraft, any level restriction issued with an earlier clearance is automatically cancelled. ATC will issue (or re-issue) any required level restrictions with new level clearances by:

- a. restating all restrictions; or
- b. prefixing the subsequent instruction with "FURTHER RESTRICTION".

**2.2.6 Entering Controlled Airspace**

2.2.6.1 When communication facilities permit, clearances will be passed direct to pilots by ATC. When direct communication on the published frequency is not possible the pilot should request a clearance through the ATS unit providing services in the preceding non-controlled airspace.

2.2.6.2 If proposing to fly into a control area from an aerodrome located so close to the entry point that making a full position report before entry is not practicable, the pilot should request a clearance:

- a. prior to entering the runway, where direct communication is available;
- b. after take-off, provided that the aircraft does not enter control area until cleared; or
- c. prior to landing, when intending to depart for controlled airspace shortly after landing.

2.2.6.3 Where the en route LSALT is in controlled airspace, the pilot should request clearance prior to departure and include an estimated airborne time.

2.2.6.4 Excluding Class D airspace, when requesting clearance and flight details have not been provided, pilots must wait for ATC to respond with their callsign before providing the flight details.

2.2.6.5 When making first contact with Approach Control, the following apply:

- a. Not Identified – report:
  - 1) DME or GNSS distance from aerodrome, if available;
  - 2) VOR radial, GNSS track or compass quadrant from the aerodrome, or if issued a STAR clearance, the STAR designator;
  - 3) assigned level;
  - 4) flight conditions, if appropriate; and
  - 5) receipt of ATIS (code);
- b. Identified – report:
  - 1) assigned level;
  - 2) flight conditions, if appropriate; and
  - 3) receipt of ATIS (code).

**2.2.7 Operations in Class D Airspace**

2.2.7.1 Within a Class D CTR, a clearance to take-off is a clearance to operate within or depart the CTR into Class G airspace in accordance with the ready report.

2.2.7.2 Two way communications established between a pilot and ATC constitutes a clearance for the aircraft to enter Class D airspace. To establish two way communications the pilot must:

- a. initiate communications and advise current position, altitude, intention, ATIS received and any request(s); and
- b. establish communications with ATC as follows in order to enter Class D airspace:

ATC Response	Communications Established	Pilot Action
<i>(aircraft callsign)</i>	Yes	– Fly the track, level and intentions stated during when initiating two way communications.  – Comply with any subsequent ATC instructions.  – When no level instruction is issued, descend as necessary to join the aerodrome traffic circuit.
<i>(aircraft callsign)</i> <i>(instructions)</i>	Yes	– Comply with ATC instructions.  – When no level instruction is issued, descend as necessary to join the aerodrome traffic circuit.
Responds to the initial radio call without using the aircraft callsign, e.g. AIRCRAFT CALLING ARCHER TOWER STANDBY, or AIRCRAFT CALLING ROCKY TOWER, SAY AGAIN	No	Remain outside Class D airspace

*Note: See GEN 3.4 for generic phraseology used by ATC when a clearance is not immediately available.*

**2.2.8 RNP AR Departures**

2.2.8.1 Pilots of aircraft that have included PBN/T1 in Field 18 of the flight notification form should request an RNP AR departure at clearance delivery unless there is a standing agreement between the Operator and the ATS provider to automatically assign RNP AR departures for eligible flights.

**2.2.9 Pre-Departure Clearance (PDC)**

2.2.9.1 Use of PDC is limited to operations authorised by Airservices Australia. Operators wishing to participate in PDC should submit a request to Airservices Australia. Participating operators must not delete any component of the PDC message nor amend the order of the text.

2.2.9.2 When departing an airport participating in PDC, pilots must obtain the PDC, via ACARS or hard copy message, no later than 15 minutes prior to EOBT. If the PDC is not available by 15 minutes prior to EOBT, pilots must contact the ACD frequency for a verbal airways clearance.

*Note: ATC will not send amended route clearances via PDC.*

2.2.9.3 Pilots must readback the following items on the ACD frequency, or on the SMC frequency if ACD is not established, prior to a pushback or taxi request:

- a. The SID, including runway and/or transition (if issued);
- b. Transponder code;

- c. Additional requirements specified in the PDC; and
- d. Current parking position/bay.

**2.2.10 Flying Training Clearances**

2.2.10.1 Pilots of multi-engined aircraft must obtain ATC approval before conducting asymmetric training within 5NM of a controlled aerodrome.

**2.2.11 Clearances for operations at night or in IMC below published LSALT**

2.2.11.1 Some flights are specially authorised to operate below the published LSALT at night or in IMC (e.g. using NVIS). The pilot in command is solely responsible for avoiding terrain in such cases. Associated clearance requests must be expressly initiated by the pilot in command and should inform ATC about the nature of the operation (e.g. NVIS, OWN TERRAIN CLEARANCE, etc.).

**2.2.12 ADF - Non SID Departures**

2.2.12.1 Unless stated otherwise in command instructions, State aircraft are not required to track via a SID. Any such departure clearance must be initiated by the pilot using the phrase: "REQUEST VISUAL DEPARTURE [NVD/NVG]" or "REQUEST (TRACKING INSTRUCTIONS)". In accepting the clearance, the aircraft captain accepts the responsibility for terrain clearance until passing MVA or LSALT.

**2.3 Ground Movement**

**2.3.1 Push Back**

2.3.1.1 The aircraft captain must obtain an approval to push back where this manoeuvre is necessary prior to taxiing. Information about other aircraft moving on the same apron will be provided by the apron service.

**2.3.2 Taxi Clearance**

2.3.2.1 When operating from a controlled aerodrome where ATIS is in operation, an aircraft captain must obtain the ATIS prior to taxi, and advise ATC of the ATIS code when requesting taxi clearance.

2.3.2.2 **ADF** - For all ADF flights, except local flights where POB never varies, the aircraft captain must provide ATC with the number of POB when requesting taxi clearance.

2.3.2.3 Pilots of civil VFR training flights should advise DUAL or SOLO, as appropriate, when requesting clearance.

2.3.2.4 The aircraft captain must obtain a taxi clearance either prior to moving on the manoeuvring area, or in the case of [sub-section 2.3.1](#), at the completion of the push-back manoeuvre.

2.3.2.5 Avoidance of collision on apron areas is a joint responsibility of the aircraft captain and any assisting company ground personnel.

2.3.2.6 VFR flights wishing to depart without submitting flight notification must provide the following information on first contact with ATC:

- a. aircraft callsign and "FLIGHT DETAILS FOR DEPARTURE" (wait for a response from ATC);
- b. destination and first tracking point;
- c. preferred level; and
- d. identification of ATIS code received.

2.3.2.7 **ADF - Dangerous cargo and explosive weapon stores.** Aircraft captains shall notify ATC of any dangerous cargo or explosive weapons stores being carried when requesting taxi and landing instructions, unless the information has been previously advised.

2.3.2.8 **ADF - Formation taxiing.** When aircraft are taxiing as a formation, individual pilots shall be responsible for maintaining the authorised separation between aircraft.

**2.3.3 Circuit Direction**

2.3.3.1 The aircraft captain must use the word "REQUIRE" to notify ATC if a particular turn or circuit is essential to the safe operation of the aircraft.

### 2.3.4 ADF - NVIS Operations

2.3.4.1 Unless stated otherwise in command instructions, State aircraft may be cleared to operate below LSALT in IMC and in VMC at night. Any such clearance must be initiated by the pilot using one of the following phrases. In accepting the clearance, the aircraft captain accepts the responsibility for terrain clearance.

- a. **IMC or Night Unaided.** The pilot must initiate the request by the use of the phrase "REQUEST (ALTITUDE), MILITARY TERRAIN CLEARANCE". ATC will clear the aircraft to operate as follows: "CLEARED (LEVEL INSTRUCTION), MILITARY TERRAIN CLEARANCE".
- b. **NVD/NVG aided.** The pilot must initiate the request by the use of the phrase "Request (ALTITUDE) NVD/NVG". ATC will clear aircraft to operate as follows: "CLEARED (LEVEL INSTRUCTION), NVD/NVG".

## 2.4 Take-Off

### 2.4.1 Tower Frequency and Information Transfer

2.4.1.1 Domestic aircraft should change to tower frequency:

- a. in the holding bay, or
- b. close to, or at, the runway-holding position of the nominated runway, when ready for take-off.

2.4.1.2 At Class D aerodromes, pilots must include the following information when reporting ready:

- a. The departure runway when parallel runway operations are in progress;
- b. Their intentions when operating wholly within a Class D CTR; and
- c. Their tracking details when departing the Class D CTR and not in receipt of an airways clearance.

### 2.4.2 Runway Entry

2.4.2.1 When a backtrack on the runway nominated for take-off is required, the pilot must obtain a clearance to backtrack prior to entering the runway.

2.4.2.2 Aircraft issued a conditional clearance to enter or cross a runway must identify the vehicle or aircraft causing the conditional clearance.

### 2.4.3 Stop Bar Contingency Procedures

2.4.3.1 If stop bar lighting cannot be deselected, the activation of stop bar contingency procedures will be notified via voice or the ATIS. ATC may instruct pilots and drivers to cross an illuminated stop bar when stop bar contingency procedures are in force.

### 2.4.4 Holding on Runway

2.4.4.1 The aircraft captain must obtain a clearance before holding on the runway in use.

### 2.4.5 ADF - Formation Takeoff

2.4.5.1 Military aircraft may require a multiple aircraft take-off. The manoeuvres concerned include the following:

- a. **Formation take-off.** The aircraft will take off in elements of two or three aircraft with other elements following at prearranged intervals. Pilots shall be responsible for maintaining separation between aircraft within the formation. Take-off clearance for all aircraft shall be obtained by the formation leader.
- b. **Stream take-off.** When aircraft take off in quick succession at prearranged intervals, the manoeuvre is known as a stream take-off. Pilots shall be responsible for maintaining separation between aircraft within the formation. Take-off clearance for all aircraft shall be obtained by the formation leader.
- c. **RAAF - Fighter scrambles.** Aircraft involved in fighter scrambles will normally be parked on the Operational Readiness Platform (ORP) and may be permitted to use the most convenient take-off direction, irrespective of wind direction, but subject to the disposition of other terminal area traffic.

Aircraft involved in the scrambles shall be responsible for maintaining their authorised separation and for providing their own collision avoidance procedure on take-off. These aircraft shall be granted priority for take-off and tower controllers shall keep other traffic clear of their take-off path and first heading.

**2.5 Visual Departure - IFR Flights**

2.5.1 By day in VMC, the pilot of an IFR flight may request a visual departure, or ATC may issue a visual departure.

2.5.2 **ADF** – By night in VMC, for State aircraft in accordance with paragraph 2.2.12.1, the pilot of an IFR flight may request a visual departure.

**2.5.3 ATC Responsibilities**

2.5.3.1 ATC will only issue a visual departure to an IFR flight when the cloud base is such that the pilot can maintain flight in VMC below the MVA (ATS surveillance services) or the MSA/LSALT.

2.5.3.2 When an IFR aircraft is issued heading instructions and/or required to maintain a level below the MVA or MSA/LSALT during a visual departure, "VISUAL" will be appended to the departure instruction.

**2.5.4 Pilot Responsibilities**

2.5.4.1 **ADF** - The requirements of this section are the visual departure procedures applicable to IFR flights.

2.5.4.2 A pilot of an IFR flight may only request a visual departure when the cloud base will allow the aircraft to climb in VMC to the MSA/LSALT applicable to the departure. Additionally, if the intended cruising level is lower than route LSALT, the cloud base must permit flight in VMC at that level.

2.5.4.3 During the conduct of a visual departure, a pilot must:

- a. maintain the track(s)/heading(s) authorised by ATC;
- b. remain not less than 500FT above the lower limit of the CTA; and
- c. visually maintain obstacle clearance.

**2.6 VFR Departure by an Aircraft Planned IFR**

2.6.1 The pilot of an IFR flight departing a Class D aerodrome may request a VFR departure with the expectation of obtaining an IFR clearance en-route.

2.6.2 The pilot of an IFR flight conducting a VFR departure:

- a. must comply with the VFR;
- b. is responsible for separation with other aircraft within the Class D airspace;
- c. must obtain ATC clearance prior to entering Class A or C airspace;
- d. must obtain ATC clearance to resume IFR in Class A, C, D or E airspace;
- e. must notify ATC when reverting to IFR once in Class G airspace.

2.6.3 When an IFR aircraft conducts a VFR departure, ATC will treat the aircraft as:

- a. VFR for separation services in Class C, D and E airspace until the pilot requests and is granted an IFR clearance;
- b. VFR in Class C or D airspace and VFR in receipt of an SIS in Class E or G airspace for traffic information;
- c. IFR for all other services, such as SAR, weather and NOTAM information, in all classes of airspace.

## 2.7 After Take-Off

### 2.7.1 Airborne Report in Airspace with ATS Surveillance

2.7.1.1 In Class C and Class D control zones where an ATS surveillance service is provided, on first contact with Centre, Approach or Departures, a pilot must report:

- a. if assigned an initial heading - the direction of turn and assigned heading;
- b. the altitude passing, to nearest 100FT; and
- c. the last assigned level.

### 2.7.2 Departure Report - Certain Class D Aerodromes

2.7.2.1 At certain Class D aerodromes where the tower also provides a procedural approach control service (see ERSA), a pilot must report on the tower frequency after take off:

- a. tracking information; and
- b. the last assigned altitude.

However, this report is not required:

- a. for VFR aircraft departing the control zone directly into Class G airspace; or
- b. for aircraft that have been instructed to contact Centre, Approach or Departures once airborne - in which case an airborne report will be made on the relevant frequency.

2.7.2.2 Tracking information must confirm the track established with reference to the appropriate navigation aid or, if tracking via a SID, confirm the SID designator.

### 2.7.3 Establishment on Track

2.7.3.1 Unless tracking via a SID or otherwise instructed by ATC, an aircraft captain must remain within 5NM of the departure aerodrome to establish flight on the departure track as soon as practicable after take-off.

### 2.7.4 Frequency Change

2.7.4.1 When frequency change instructions are issued immediately preceding the take-off clearance, pilots must transfer automatically from Tower as soon as practicable after take-off, preferably within one mile of becoming airborne.

2.7.4.2 In all other situations, pilots of departing aircraft are required to remain on Tower frequency until specific frequency change instructions are issued. Pilots can generally expect an instruction to contact Departures Control prior to reaching 2,000FT and should, when advised, effect the change as soon as possible.

2.7.4.3 When contacting Area Control, pilots must advise the last assigned level and, if not maintaining the assigned level, the level maintaining or last vacated level.

*Note: The "last vacated level" may be omitted by identified aircraft squawking pressure altitude derived level information.*

## 2.8 VFR Climb and Descent - IFR Flights

### 2.8.1 General

2.8.1.1 A pilot of an IFR flight, operating in VMC, in classes D and E airspace, may request to climb/descend VFR.

2.8.1.2 When, in the controller's judgement, there is reason to believe that flight in VMC may become impracticable, the controller will issue an alternative clearance that ensures separation from all other aircraft for which they have separation responsibility.

2.8.1.3 The pilot of an IFR flight cleared to "Climb/Descend VFR" will receive a service in accordance with [paragraph 2.8.3.2](#).

2.8.1.4 An appropriate clearance must be obtained prior to entering a different class of controlled airspace.



### 2.8.2 Pilot Procedures

2.8.2.1 The pilot of an IFR flight requires a clearance to conduct a VFR climb/descent in VMC.

2.8.2.2 When operating in VMC with an ATC clearance to “Climb/Descend VFR”, pilots of IFR flights must:

- a. comply with the VFR visibility and distance from cloud criteria stipulated in ENR 1.2 [Section 2](#);
- b. comply with instrument flight rules that are applicable to the flight; i.e., position reporting, radio communications, cleared route, adherence to ATC clearance, etc.; and
- c. visually maintain obstacle clearance.

2.8.2.3 The pilot of an IFR flight operating VFR climb/descent must maintain vigilance so as to see and avoid other aircraft. Additionally, the pilot accepts the responsibility for wake turbulence separation.

### 2.8.3 ATC Procedures

2.8.3.1 On receiving a request for VFR climb/descent, ATC may instruct the pilot to “Climb/Descend VFR” for a specified portion of the flight.

2.8.3.2 When the pilot is cleared to “Climb/Descend VFR”, ATC will provide:

- a. mutual traffic information service on IFR flights;
- b. traffic information service on known VFR flights as far as practicable; and
- c. a flight information service.

*Note: IFR separation is not provided.*

## 2.9 VFR-On-Top - IFR Flights

### 2.9.1 General

2.9.1.1 In Class E airspace, a pilot of an IFR flight may request VFR-on-Top in lieu of an assigned altitude. This permits a pilot to select a VFR altitude or flight level of their choice subject to any ATC restrictions.

2.9.1.2 Pilots desiring to climb through cloud, haze, smoke or other meteorological formation may request a climb to VFR-on-Top.

2.9.1.3 ATC clearance to “Maintain VFR-on-Top” is not intended to restrict pilots so that they must operate only above an obscuring meteorological formation (layer). Instead, the clearance permits operation above, below, between layers or in areas where there is no meteorological obscuration.

2.9.1.4 When, in the controller’s judgement, there is reason to believe that flight in VMC may become impracticable, the controller must issue an alternative clearance that ensures separation from all other aircraft for which they have separation responsibility.

2.9.1.5 The pilot of an IFR flight cleared to “Maintain VFR-on-Top” will receive a service in accordance with [paragraph 2.9.3.2](#).

2.9.1.6 An appropriate clearance must be obtained prior to entering a different class of controlled airspace.

2.9.1.7 ATC resumes separation responsibility when the aircraft is recleared to maintain an IFR level.

### 2.9.2 Pilot Procedures

2.9.2.1 The pilot of an IFR flight requires a clearance to operate VFR-on-Top.

2.9.2.2 When operating with an ATC clearance to “Maintain VFR-on-Top”, pilots on IFR flight plans must:

- a. fly at the appropriate VFR levels as prescribed in ENR 1.7 [Section 5](#);
- b. comply with the VFR visibility and distance from cloud criteria stipulated in ENR 1.2 [Section 2](#);
- c. comply with instrument flight rules that are applicable to the flight; i.e., minimum IFR altitudes, position reporting, radio communications, cleared route, adherence to ATC clearance, etc.; and

- d. advise ATC prior to any altitude change to ensure the exchange of accurate traffic information.

2.9.2.3 The pilot of an aircraft operating VFR-on-Top must maintain vigilance so as to see and avoid other aircraft. Additionally, the pilot accepts the responsibility for wake turbulence separation.

### 2.9.3 ATC Procedures

2.9.3.1 On receiving a request for VFR-on-Top, ATC may instruct the pilot to climb to "VFR-on-Top". This instruction will include:

- a. if required, a clearance limit, routing and an alternative clearance if VFR-on-Top is not reached by a specified altitude;
- b. the requirement to report reaching VFR-on-Top; and
- c. the reported height of the tops or that no tops reports are available.

2.9.3.2 When the pilot reports reaching VFR-on-Top, ATC re-clears the aircraft to "Maintain VFR-on-Top" and will provide:

- a. mutual traffic information service on IFR flights,
- b. traffic information service on known VFR flights as far as practicable, and
- c. a flight information service.

*Note: IFR separation is not provided.*

2.9.3.3 ATC will not clear an aircraft to "Maintain VFR-on-Top" at night to separate holding aircraft from each other or from en route aircraft unless restrictions are applied to ensure the appropriate IFR vertical separation.

## 2.10 En Route

2.10.1 All levels flown in classes A, C and D airspace, and IFR levels flown in Class E airspace, must be assigned by ATC. Levels flown by VFR aircraft or IFR flights maintaining VFR-on-Top in Class E airspace must be in accordance with the VFR Table of Cruising Levels.

2.10.2 Except when identified, position reports are required for all aircraft in classes A, C and D airspace, and for IFR flights or flights using the IFR Pick-up procedure after initial contact with ATC in classes E and G airspace.

### 2.10.3 Reports

2.10.3.1 The position report format appears at GPA GEN 3.4 [APPENDIX 1](#). Section 2 of the report should only be transmitted when required by the operator or when deemed necessary by the pilot. Section 3 of the report is required for the situations described in [APPENDIX 1](#).

2.10.3.2 Aircraft operating area-type flights and nominating scheduled reporting times may limit the report to "level" and the "present position" or the sector of the survey area in which the aircraft is currently operating.

2.10.3.3 Pilots must give ATS notice of an impending position report by use of the word "position"; e.g., "MELBOURNE CENTRE (call-sign) POSITION". Pilots must wait for the ATS instruction before reporting position.

2.10.3.4 Pilots must report maintaining an assigned level, unless ATC has advised IDENTIFIED. An IFR flight operating VFR-on-Top or requesting IFR Pick-up must advise level maintaining.

2.10.3.5 After any frequency change, pilots must advise the last assigned level and, if not maintaining the assigned level, the level maintaining or last vacated level.

*Note: The "last vacated level" may be omitted by identified aircraft squawking pressure altitude derived level information.*

2.10.3.6 Pilots should normally report ETA at the place of intended landing when at the last position report.

### 2.10.4 ADF - Flights Exempt from Reporting Position to Civil ATC

2.10.4.1 Military flights in the following categories are not required to make routine position reports to civil ATC:

- a. Flights outside of controlled airspace using "area guard" communications.
- b. Aircraft operating under "radio silence" conditions.

*Note: Due regard is given by the military control authority to the need for adequate anti-collision measures to be taken in the planning stages of these flights. If they are to take place in controlled airspace, special reservation shall be arranged.*

- c. Aircraft operating in a portion of controlled airspace which has been reserved exclusively for military use.
- d. Aircraft operating under NOCOM procedure when within the nominated route segment(s) where communication is expected to be non-continuous, except that, where possible, short position reports may be made.

*Note: Military aircraft normally operate NOCOM in military Restricted Areas and Class G airspace only. ATC approval is required prior to flight planning NOCOM in controlled airspace.*

- e. Aircraft operating under SARTIME procedure except that, where applicable and possible, reports shall be made.

## 2.11 Descent and Approach

### 2.11.1 General

2.11.1.1 Most companies operating jet aircraft have agreed to a standard descent profile which may be specified in the operator's operational document suite. Pilots must adhere to the profile unless operational reasons require, or ATC instructs or approves, otherwise. A sustained speed variation of more than  $\pm 10\text{KT}$  IAS or  $\pm M0.02$  must be advised to ATC.

2.11.1.2 Pilots are not required to nominate a descent point if identified.

2.11.1.3 Pilots of IFR flights leaving classes A, C, D, or E airspace should, before entering Class G airspace, contact the ATS unit providing services in that airspace.

2.11.1.4 **ADF** - For all ADF flights, except local flights where POB has already been advised or never varies, the aircraft captain must provide ATC with the number of POB on first contact with the Tower.

### 2.11.2 Instrument Approach

2.11.2.1 **ATC Authorisation**. Unless authorised to make a visual approach, an IFR flight must conform to the published instrument approach procedure nominated by ATC.

2.11.2.2 A pilot request to conduct a specific approach should be made prior to STAR clearance issue, or prior to top of descent for arriving aircraft not on a STAR eligible route.

2.11.2.3 Authorisation for final approach will be in the form of a clearance for the type of approach as shown on the approach chart title. If visual at the minima, the nominated runway then becomes the clearance limit subject to any further ATC instructions and a clearance to land. In the event that the aircraft is unable to land from the instrument approach or loses visual reference whilst circling, the aircraft is cleared to carry out the published missed approach unless ATC directs otherwise. The aircraft captain must seek further ATC instructions prior to reaching the end of the missed approach procedure.

2.11.2.4 Where an instrument approach results in the aircraft leaving controlled airspace, the clearance for the approach also provides clearance for the aircraft to re-enter overlying controlled airspace, Restricted or Military Operating Area in the event of a missed approach. ATC should be advised as soon as possible on the missed approach.

2.11.2.5 The chart title for an instrument approach procedure is used for all radiotelephony relating to the procedure (including entry procedures), subject to the following:

- a. The word 'APPROACH' is included between 'type of approach' (VOR, ILS, RNP etc. including any procedure suffix) and the runway designator (RUNWAY 01, RWY 33 etc).
- b. If multiple approach procedures are on the same chart, e.g. 'NDB-A and VOR-A', only the approach procedure being conducted should be referred to.

- c. If the chart title has a parenthetical suffix, e.g. (LNAV/VNAV ONLY), (AR), the text in the parentheses is not included in radiotelephony.
- d. A runway designator shown as optional in a radiotelephony phrase (e.g. [RUNWAY (number)]) should only be omitted when there is no possibility of confusion.
- e. Other than for circling approaches, a procedure suffix (X, Y, etc.) may be omitted if there is no possibility of confusion.

2.11.2.6 Aircraft may be instructed to track via an instrument approach procedure and a level restriction assigned, if the aircraft is:

- a. in VMC conducting instrument approach training; or
- b. a military aircraft:
  - 1) conducting a non-precision approach; or
  - 2) conducting a precision approach provided that clearance for the approach is issued in sufficient time for the aircraft to maintain the required descent rate in accordance with the published procedure.

### 2.11.3 Visual Approach (rules related to ATC)

2.11.3.1 **ATC authorisation.** Except as detailed in [paragraph 2.11.3.2](#), the criteria under which visual approaches may be authorised by ATC are as follows:

- a. For an IFR flight:
  - 1) By day (**ADF** - or by night using NVD/NVG within Military CTR/CTA/RA) when:
    - i the aircraft is within 30NM of the aerodrome; and
    - ii the pilot has established and can continue flight to the aerodrome with continuous visual reference to the ground or water; and
    - iii visibility along the flight path is not less than 5,000M, or for helicopters 800M, or the aerodrome is in sight.
  - 2) By night when:
    - i the pilot has established and can continue flight to the aerodrome with continuous visual reference to the ground or water; and
    - ii visibility along the flight path is not less than 5,000M; and
    - iii the aircraft is within 30NM of the aerodrome; or
    - iv if being vectored, the flight has been assigned the MVA and given heading or tracking instructions to intercept final or to position the aircraft within the circling area of the aerodrome.
- b. For a VFR flight by day and night, the aircraft is within 30NM of the aerodrome.

2.11.3.2 In addition to the requirements of [paragraph 2.11.3.1](#), with the exception of Australian and New Zealand operators and aircraft conducting independent visual approaches at Sydney, SUPER or HEAVY jet aircraft will only be assigned a visual approach when:

- a. specifically requested by the pilot, and the pilot has reported the landing runway in sight; or
- b. the straight-in approach aid is unserviceable.

2.11.3.3 In the case of sub-paragraph 2.11.3.2.b. above, the aircraft will be:

- a. vectored to intercept final no closer than 8NM from the runway threshold, at an altitude not less than 2,500FT Above Aerodrome Level (AAL); and
- b. assigned a straight-in visual approach when:
  - 1) established on final or on a heading to intercept final course at an angle of not more than 30 degrees; and
  - 2) visual glideslope guidance (VASIS/PAPI) is available; and
  - 3) the pilot has reported the landing runway in sight.

2.11.3.4 **Circuit Joining.** ATC may issue an instruction to join on a leg of the circuit or via:

- a. Upwind, which directs circuit entry tracking upwind over the nominated runway centreline at the specified altitude; or
- b. Overfly, which directs circuit entry into the opposing circuit by overflying the nominated runway at the specified altitude.

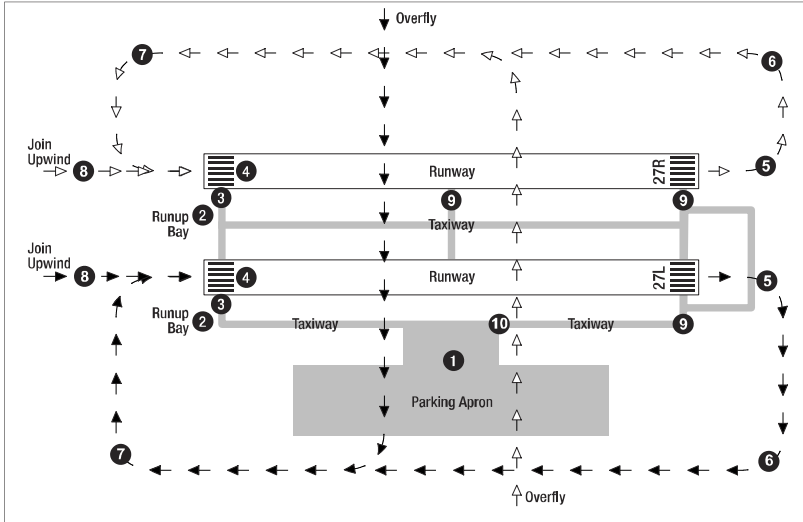

Decode information for the above diagram:

- 1) Aircraft initiates call to taxi - clearance provided
- 2) Aircraft vacating the bay give way to aircraft on the taxiway
- 3) Line up or take-off clearance issued here
- 4) Take-off clearance issued if not issued at position 3
- 5) Crosswind leg
- 6) Downwind leg
- 7) Base leg
- 8) Final (joining upwind) leg  
Landing clearance issued here unless issued on downwind/base leg
- 9) Taxi instructions, if required
- 10) Parking information issued if necessary

2.11.3.5 A pilot reporting VISUAL, may initially be given a clearance below the LSALT to a specific altitude in the following terms:

- a. by day - "DESCEND TO (level) VISUAL"; or
- b. by night - "WHEN ESTABLISHED IN THE CIRCLING AREA, DESCEND TO (level) VISUAL".
- c. **ADF** - by night using NVD/NVG - "DESCEND TO (level) NVD/NVG".

*Note: The requirements for pilots and operators relating to the conduct of, or making a request to conduct a visual approach are contained in ENR 1.5 paragraph 1.14.*

2.11.3.6 **ADF - Military initial and pitch flight category.** Pilots conducting a military initial and pitch (described in ENR 1.1 Section 9.15) are automatically changed to the Visual Flight Rules (VFR) flight category provided all of the following apply:

- a. the aircraft is an ADF aircraft or an approved operator's aircraft
- b. the aerodrome is a military or joint-user aerodrome
- c. ATC has assigned tracking via initial
- d. the aircraft has passed the initial point (IP).

2.11.3.7 A pilot request to operate and remain IFR or Special VFR during operations in the circuit must be made at the earliest opportunity, typically prior to the IP, and may require approach delays.

2.11.3.8 Pilots require specific clearance to depart the circuit or change flight category once the aircraft has passed the IP.

## 2.12 Landing

2.12.1 **Provision of operational information.** ATC will supply the following information for landing operations:

- a. runway or direction;
- b. wind direction and speed, QNH and, if required, temperature and/or dew point;
- c. known significant weather information, including low cloud and visibility or runway visual range;
- d. the crosswind component on the runway to be used, if this equals or exceeds 8KT for single-engined aircraft, **(ADF)** 10KT for military aircraft, or 12KT for multi-engined aircraft;
- e. the tailwind component;
- f. aerodrome surface conditions significant to the operation including maintenance work within 23M of the runway side stripe marking;
- g. birds or other hazards to aircraft; and
- h. cautionary advice of wake turbulence.

2.12.2 **Selection of landing direction.** The aircraft captain must ensure that the nominated runway or direction is operationally suitable. If the nominated runway or direction is not suitable then ATC must be advised using the phrase "REQUIRE RUNWAY (number)". Such a request will not result in loss of priority provided it is made:

- a. before reaching 80NM (120NM for jets) from a capital city aerodrome (including Essendon) or 30NM from other controlled aerodromes, for arriving aircraft wholly within controlled airspace; or
- b. on first contact with ATC for arriving aircraft entering controlled airspace within the distance specified above or a control area step or a control zone.

The decision to land rests solely with the aircraft captain.

2.12.3 **Selection of circuit direction.** An aircraft captain must notify ATC if a particular turn or circuit is essential to the safe operation of the aircraft. The word "REQUIRE" must be used to enable ATC to identify the safety requirement.

2.12.4 **Downwind report to Tower.** Unless otherwise instructed by ATC, the pilot of an arriving or circuit training aircraft must report DOWNWIND when starting or entering the downwind leg of the traffic circuit. If frequency congestion prevents the call being made when starting the downwind leg, the pilot must report MID-DOWNWIND or LATE-DOWNWIND as appropriate.

2.12.5 **Clearances.** An aircraft captain must not land unless the specific clearance "CLEARED TO LAND" has been received.

*Note: ATC approval must be obtained if asymmetric training is to be carried out within 5NM of a controlled aerodrome (see sub-section 2.2.10).*

2.12.5.1 **ADF - Landing Sequences at Military Aerodromes** If a military aircraft requests permission to land when there is another aircraft ahead, a landing sequence number shall be allotted to the second aircraft. The second aircraft shall check for a landing clearance on final leg if one has not been issued. All subsequent aircraft in a sequence shall be issued with similar instructions. Formations will be assigned a single sequence number however will be counted as separate elements for the provision of sequence numbers to following aircraft.

**2.12.6 Separation Minima for Landing**

2.12.6.1 The appropriate wake turbulence separation standard will be applied by ATC between landing aircraft, except when a pilot has been assigned responsibility to maintain separation with another aircraft.

2.12.6.2 A landing aircraft will not be permitted to cross the threshold of the runway on its final approach until:

- a. a preceding departing aircraft using the same runway:
  - 1) is airborne, and
    - has commenced a turn; or
    - is beyond the point on the runway at which the landing aircraft could be expected to complete its landing roll and there is sufficient distance to manoeuvre safely in the event of a missed approach;
  - 2) is at least 1,000M from the runway threshold, and
    - has commenced the take-off run, and
    - in the opinion of the controller, no collision risk exists, and
    - the aircraft taking off has a MTOW of 7,000KG or less, and
    - the landing aircraft is performance Category A and has a MTOW below 3,000KG.
- b. a preceding landing aircraft using the same runway:
  - 1) has vacated it and is taxiing away from the runway; or
  - 2) has landed and has passed a point at least 1000M from the threshold of the runway and will vacate the runway without backtracking, and
    - in the opinion of the tower controller, no collision risk exists, and
    - the preceding landing aircraft has a MTOW of 7,000KG or less, and
    - the following landing aircraft is performance Category A and has a MTOW below 3,000KG; or
  - 3) has landed and has passed a point at least 600M from the threshold of the runway, is in motion and will vacate the runway without backtracking; and
    - the preceding landing aircraft has a MTOW of less than 7,000KG, and
    - the following landing aircraft has a MTOW of 2,000KG or less, or
  - 4) in the case where the following landing aircraft is a helicopter, the preceding landing aircraft is at least 300M down the runway from the threshold and ATC is satisfied that no collision risk exists.
- c. a preceding aircraft, using a different runway, has crossed or stopped short of the landing aircraft's runway.

In the above situations, a landing clearance may be issued if ATC expect that the required runway separation standard will exist.

2.12.6.3 Other than as specified in *para 7.5.1*, exceptions to separation minima are:

- a. aircraft landing in formation with respect to each other (refer paragraph 2.12.6.4) and
- b. aircraft operating in different areas or lanes on aerodromes with runways or facilities suitable for simultaneous landings.

2.12.6.4 **ADF - Formation Landings.** The leader of a formation shall obtain permission to join the traffic circuit on behalf of the whole formation. All pilots in the formation shall maintain a listening watch on the TOWER frequency. When aircraft land in formation, the tower controller shall allocate one landing sequence number to the formation. When the aircraft carry out a stream landing on the same runway in quick succession, a landing clearance shall be obtained by the formation leader. Individual pilots are responsible for providing their own separation during and after landing. Individual pilots of a formation shall report at the base leg position.

2.12.6.5 **ADF - Touch-and-Go Landings.** Pilots shall nominate on base leg or on final in the case of a straight-in approach, their intention to make a touch-and-go landing.

2.12.6.6 **ADF - Full-Stop Landings.** At military aerodromes a controller shall not instruct a military aircraft to make a full-stop landing. They may, however, request a pilot to make a full-stop landing due traffic. An arriving aircraft can be expected to make a full-stop landing unless advice to the contrary is received.

2.12.6.7 **ADF - Dangerous Cargo and Explosive Weapon Stores.** Pilots of military aircraft shall notify ATC of any dangerous cargo or explosive weapons stores being carried when requesting landing instructions, unless the information has been previously advised.

2.12.6.8 **ADF - Reduced Runway Separation Standards.** Defence ATC may apply reduced Runway Separation Standards (RRSS) between approved operators, subject to the following requirements.

- a. **Preceding landing aircraft.** The preceding landing aircraft using the same runway is both:
  - 1) landed and passed the distance specified from the landing threshold; and
  - 2) in motion and will vacate without backtracking.
- b. **Preceding departing aircraft.** The preceding departing aircraft has commenced the take-off roll and reached a point at least that distance specified:
  - 1) from the landing threshold (for a following landing or touch-and-go aircraft)
  - 2) ahead of the following departing aircraft (for a pilot to be cleared for take-off).

*Note: The preceding aircraft may be considered 'departing' when commencing acceleration from a touch-and-go or has reached a point on the runway where the required landing distance for the following aircraft is assured.*

- c. **Landing clearance.** When RRSS is applied, ATC will follow the landing clearance with the number of airborne aircraft 'AHEAD' (between the pilot receiving clearance and the landing threshold) and the number of aircraft 'ON' the runway.
- d. **Phraseology:** '(callsign) CLEARED TO LAND, ((number) AHEAD, (number) ON)'

*Note: ATC does not need to withhold issuing clearance to the following aircraft for landing or touch-and-go provided ATC is reasonably assured the RRSS will be achieved when the landing aircraft crosses the runway landing threshold.*

2.12.6.9 ADF - Application of RRSS is subject to the following conditions:

- a. Runway surface condition is DRY, unless alternative conditions are published within the relevant FIHA AD2 SUPP.
- b. Wind is within aircraft limitations.
- c. Visual conditions allow the following pilot to maintain sight of the preceding aircraft during take-off or landing, as applicable.
- d. Status of arrestor cable is suitable for preceding and following aircraft. ATC may ask the pilot to confirm intention to vacate prior to reaching the cable site or to trample the cable.
- e. No abnormal aerodrome or runway conditions, and emergency aerodrome lighting is not in use.
- f. Aircraft involved are not subject to an abnormal operation that may necessitate exclusive use of the runway, which includes use of brake parachutes or drogue parachutes.



- g. Preceding landing aircraft must move to the exit side of the runway (cold lane) to make the non-exit side of the runway available for use as a passing lane (hot lane).

**Table: Reduced Runway Separation Standard Distances (feet)**

		Following Aircraft								
		F-35A	F/A-18F EA-18G	Pair F/A-18F EA-18G	Hawk	Pair Hawk	Lear Jet	PC-21	Pair PC-21	B300 KA350
<b>Leading Aircraft</b>	<b>F-35A</b>	3000	6000	6000	6000	6000	6000	6000 <sup>1</sup>	6000 <sup>1</sup>	NA
	<b>F-35A Pair</b>	6000	6000	6000	6000	6000	6000	6000 <sup>1</sup>	6000 <sup>1</sup>	NA
	<b>F/A-18F, EA-18G</b>	6000	3000	6000	6000	6000	3000	3000 <sup>1</sup>	5000 <sup>1</sup>	6000 <sup>1</sup>
	<b>Pair F/A-18F, EA-18G</b>	6000	3000	6000	6000	6000	3000	3000 <sup>1</sup>	5000 <sup>1</sup>	6000 <sup>1</sup>
	<b>Hawk</b>	6000	6000	6000	3000	6000	3000	3000	5000	6000
	<b>Pair Hawk</b>	6000	6000	6000	6000	6000	3000	3000	5000	6000
	<b>Lear Jet</b>	NA	6000	6000	4000	6000	3000	3000	5000	NA
	<b>PC-21</b>	NA	6000	6000	4000	6000	6000	3000	5000	4000
	<b>Pair PC-21</b>	NA	6000	6000	4000	6000	6000	3000	5000	4000
	<b>B300 KA350</b>	NA	NA	NA	NA	NA	NA	3000 <sup>2</sup>	5000 <sup>2</sup>	4000 <sup>2</sup>

Notes:  
 1. IAW ENR 1.4-2.3.1, ATC is not required to apply wake turbulence separation when a VFR aircraft is landing on the same runway as a preceding HEAVY or MEDIUM wake turbulence category aircraft. ATC applies wake turbulence separation for departing aircraft unless the pilot requests a wake-turbulence waiver.  
 2. CAUTION: No hot lane available and KA350 may abort take-off during a touch and go.

**ENR 1.1**

**2.13 Circuit Operations**

**2.13.1 Sequencing**

2.13.1.1 When appropriate, ATC will issue a sequencing instruction.

2.13.1.2 In sequencing aircraft ATC will indicate the position of the preceding aircraft by reference to a leg of the circuit or as a clock bearing, and describe it either as a specific type or in general terms (e.g. Cessna or Twin).

2.13.1.3 ATC may issue a sequence number. Sequence numbers specify the landing sequence position of an aircraft with respect to any preceding traffic.

2.13.1.4 When issued with a sequencing instruction, a pilot must follow the preceding aircraft and continue to do so unless otherwise instructed by ATC.

2.13.1.5 The instruction **FOLLOW** requires the pilot to sight the preceding aircraft, and regulate circuit speed and approach path to achieve longitudinal separation. If the preceding aircraft cannot be sighted and identified, the pilot must advise ATC.

### 2.13.2 Non-Standard Circuit Operations

2.13.2.1 Pilots must advise ATC of non-standard circuit operations, e.g. glide and flapless circuits, normally with the DOWNWIND report. This advice will also alert other circuit traffic. ATC must also be advised at the earliest opportunity of single engine aircraft conducting simulated engine failure.

2.13.2.2 Where appropriate, an ATC sequencing instruction will indicate that there are no traffic restrictions precluding the manoeuvre. Subject to traffic, ATC may deny, or apply parameters to such operations for traffic management purposes.

### 2.13.3 Parallel Runway Operations at Class D Aerodromes

2.13.3.1 Where a Class D aerodrome is equipped with parallel runways, ATC may sequence aircraft for simultaneous contra-circuits and may conduct these operations using separate Tower frequencies for each runway. Operations will be regulated independently in each circuit, with an ATC clearance required to enter the opposite circuit or airspace.

### 2.14 Go Around and Missed Approach Procedure in VMC

2.14.1 Except as specified in ERSA for specific locations, an aircraft that is required to go around from a visual approach in VMC must initially climb on runway track, remain visual and await instructions from ATC. If the aircraft cannot clear obstacles on runway track, the aircraft may turn.

2.14.2 In the event that an aircraft is unable, or does not wish, to land from an instrument approach in VMC, the aircraft must carry out the published instrument missed approach procedure for the instrument approach being flown, unless ATC directs otherwise.

2.14.3 At Class D aerodromes with parallel runways where contra-rotating circuit operations are in progress, if ATC instructs, or a pilot initiates a go around, the pilot must:

- a. commence climb to circuit altitude;
- b. position the aircraft on the active side and parallel to the nominated duty runway, while maintaining separation from other aircraft; and
- c. follow ATC instructions or re-enter the circuit from upwind.

### 2.15 Taxiing After Landing

2.15.1 An aircraft captain must not hold on the runway in use unless ATC has so authorised.

2.15.2 After landing, unless specified otherwise by ATC, an aircraft must comply with the following:

- a. Promptly vacate the runway without backtracking.
- b. Change from the tower frequency to the ground frequency (where established) when vacating the runway strip, and obtain an ATC taxi instruction.
- c. Not cross any runway that intersects the taxi route unless in receipt of a taxi instruction and a "CROSS RUNWAY (number)" instruction from ATC.
- d. Taxi to the destination via the most direct taxiway(s) available.
- e. Where an apron service is provided on a discrete frequency (see ERSA), change to that frequency on entering the apron.

2.15.3 A taxi instruction which contains a taxi limit beyond a runway must include a "CROSS RUNWAY (number)" instruction to cross that runway. When an aircraft is required to hold short of a runway intersecting the taxi route, ATC will issue a taxi instruction limit of the runway-holding position associated with the intersecting runway.

2.15.4 An aircraft which has been issued with a taxi instruction limit of the runway-holding position of a runway intersecting the taxi route, or which has been issued with an instruction to "HOLD SHORT" of that runway, must subsequently be issued with an instruction to "CROSS RUNWAY (number)".

2.15.5 Aircraft required to hold short of a runway must hold at the appropriate runway-holding position for that runway, or the runway strip edge at the intersection of a crossing runway.

2.15.6 When separate frequencies for aerodrome control and surface movement control are in use, the aircraft captain, on landing, must change from the aerodrome control frequency to the SMC frequency on vacating the runway strip, and then transmit the aircraft call-sign and, if applicable, parking bay number. An aircraft captain may "REQUEST DETAILED TAXI INSTRUCTIONS TO (location)".

2.15.7 The taxi clearance regulates movement on the manoeuvring area. The separation of aircraft taxiing on the manoeuvring area is a joint pilot and controller responsibility. Taxi clearance shall contain concise instructions and adequate information so as to assist flight crew to follow the correct taxi routes, to avoid collision with other aircraft and objects and to minimise the potential for the aircraft inadvertently entering a runway.

2.15.8 A taxi clearance will not relate to movement on the apron areas. However, available essential information referring to other aircraft entering or leaving the same apron area will be provided.

2.15.9 Radio watch must be maintained on the SMC or tower frequency (where no SMC frequency is provided) until parked.

### 3. Operations In Class E Airspace

#### 3.1 ATC Traffic Services

3.1.1 In Class E airspace, IFR and VFR flights are permitted. IFR flights are provided with an air traffic control service, are separated from other IFR flights, and receive traffic information on VFR flights as far as is practicable. VFR flights receive a Surveillance Information Service (SIS), where available, on request.

3.1.2 Traffic information services provided by ATC do not relieve pilots of their responsibilities for continued vigilance to see and avoid other aircraft.

3.1.3 When vectors are provided to IFR flights in Class E airspace, terrain clearance will be provided by ATC. However, in VMC by day, pilots may be assigned responsibility for terrain clearance by the use of the words "DESCEND TO (level)/CLIMB TO (level)/TURN RIGHT/TURN LEFT (degrees) VISUAL".

3.1.4 In Class E airspace, the following also apply:

- a. Hazard alerts will be directed to pilots of IFR flights, and to pilots of known VFR flights.
- b. Unless operationally required by a pilot, ATC will only assign IFR levels.

#### 3.2 VFR Flights in Class E Airspace

3.2.1 VFR flights entering Class E airspace do not require a clearance, but may receive a Surveillance Information Service (SIS), where available, on request (see GPA GEN 3.3).

3.2.2 VFR flights entering and operating in Class E airspace should:

- a. avoid published IFR routes, where possible;
- b. monitor the appropriate Class E frequency and announce if in potential conflict; and
- c. take appropriate action to avoid potential conflict.

3.2.3 Pilots of VFR flights should avoid IFR holding patterns.

### 4. NAVIGATION REQUIREMENTS

#### 4.1 Flight Under the IFR

4.1.1 An aircraft operating under the IFR must be navigated by:

- a. an approved area navigation system that meets performance requirements of the intended airspace or route, or
- b. use of a radio navigation system or systems on routes where, after making allowance for possible tracking errors of  $\pm 9^\circ$  from the last positive fix, the aircraft will come within the rated coverage of a radio aid which can be used to fix the position of the aircraft. The maximum time interval between positive fixes must not exceed two (2) hours; or

- c. visual reference to the ground or water by day, on route segments where suitable en route radio navigation aids are not available, provided that weather conditions permit flight in VMC and the visual position fixing requirements of paragraph 4.2.1b. are able to be met.

#### 4.2 Flight Under the VFR

4.2.1 The following apply in respect of flight under the VFR:

- a. The aircraft captain must navigate the aircraft by visual reference to the ground or water, or by using any of the methods specified in [paragraph 4.1.1](#).
- b. When navigating by visual reference to the ground or water, the aircraft captain must positively fix the aircraft's position by visual reference to features shown on topographical charts at intervals not exceeding 30MIN. When flying over the sea, such features may include rocks and reefs and fixed man-made objects which are marked on suitable charts and are readily identifiable from the air.

*Note: Flight above more than SCT cloud, or over featureless land areas, or over the sea, may preclude visual position fixing at the required intervals and may therefore make visual navigation impracticable.*

- c. When navigating by visual reference in controlled airspace the pilot must notify ATC if the aircraft's track diverges by more than 1NM from the track approved by ATC, or, if navigating by reference to radio navigation aids, by more than the tolerances given in [paragraph 4.6](#).
- d. VFR flight on top of more than SCT cloud is available provided that:
- 1) VMC can be maintained during the entire flight, including climb, cruise and descent.
  - 2) For VFR flight on top of more than SCT cloud, the visual position fixing requirements of [sub-paragraph b](#), or the other navigational requirements of [sub-section 4.1](#), must be met.
  - 3) Prior to conducting a VFR flight on top of more than SCT cloud, the aircraft captain must ensure that current forecasts and observations (including those available in-flight observations) indicate that conditions in the area of, and during the period of, the planned descent below the cloud layer will permit the descent to be conducted in VMC.
  - 4) The position at which descent below cloud is planned to occur must be such as to enable continuation of the flight to the destination and, if required, an alternate aerodrome in VMC (see Note).
- e. When navigating by reference to radio navigation aids or GNSS, the aircraft captain must obtain positive radio fixes at the intervals and by the methods prescribed in [paragraph 4.1](#) and [4.5](#).
- f. The aircraft captain of a VFR flight wishing to navigate by means of radio navigation systems or any other means must indicate in the flight notification only those radio navigation aids with which the aircraft is equipped and the pilot is competent to use.

*Note: Pilots should not initiate VFR flight on top of more than SCT cloud when weather conditions are marginal. Before committing to operate VFR flight on top of more than SCT cloud, pilots should be confident that meteorological information used is reliable and current, and clearly indicates that the entire flight will be able to be conducted in VMC.*

#### 4.3 Time

4.3.1 During flight, pilots must maintain a time reference accurate to within  $\pm 30$ SEC.

#### 4.4 Track Keeping

4.4.1 Tolerances are applied to tracks to assess containment areas for the purposes of ensuring navigational integrity, separation from other aircraft, terrain and obstacle clearance, and avoidance of specified airspaces. Although allowing for the errors inherent in the navigation systems used, these tolerances are based on the assumption that the pilot will maintain track as closely as possible.

4.4.2 The aircraft captain must, at all times, take positive action to regain track as soon as a deviation from the correct track is recognised.

4.4.3 Aircraft must be navigated by the most precise means of track guidance with which the aircraft is equipped and the pilot is qualified to use.

The order of precision is Localiser, GNSS, VOR/TACAN, then NDB.

#### 4.5 Position Fixing

4.5.1 A positive fix is one determined by:

- a. the passage of the aircraft over an NDB, VOR, TACAN, marker beacon or a DME site; or
- b. the intersection of two or more position lines which intersect with angles of not less than 45° and which are obtained from NDBs, VORs, TACANs, localisers or DMEs in any combination. For the purpose of this paragraph, a position line must be within the rated coverage of the aid with the exception that if a fix is determined entirely by position lines from NDBs, the position lines must be within a range of 30NM from each of the NDBs; or
- c. **ADF** - GNSS meeting the requirements of GEN 1.5 Section 2.

#### 4.6 Aircraft Deviations in Controlled Airspace - Advice to ATC

4.6.1 In controlled airspace, separation standards are based on the pilot maintaining route or track as closely as possible at all times. Corrective action must be taken to regain route or track as soon as any deviation is observed.

4.6.2 Additionally, the pilot must immediately notify ATC for any of the deviations described below:

- a. where route or track guidance is provided by a localiser or VOR/TACAN - half-scale deflection or more of the Course Deviation Indicator (CDI);
- b. where route or track guidance is provided by NDB -  $\pm 5^\circ$  or more from the specified bearing;
- c. where route or track guidance is provided by DME -  $\pm 2$ NM or more from the required arc;
- d. where route or track guidance is provided by an area navigation system - when the aircraft cannot be maintained on the desired track plus/minus the prescribed RNP/RNAV value; and
- e. when navigating by visual reference to the ground or water - more than 1NM from the cleared route or track.

*Note: The values given above must not be interpreted as defining a sector within which the pilot is permitted to navigate or tolerances within which deviations from route or track without clearance are permitted.*

#### 4.7 Long Over-Water Flights

4.7.1 If an aircraft on a long over-water flight operating in Oceanic Class A airspace has inadvertently deviated from the route specified in its ATC clearance, the pilot must take action to regain the cleared route within 200NM from the position at which the deviation was observed.

#### 4.8 GNSS - Operations Without RAIM

4.8.1 ATS services, in particular aircraft separation, are predicated on accurate aircraft navigation and position fixing. If GNSS integrity is not assured, due to loss of RAIM or RAIM ALERT, the navigation system does not meet the required standard for navigation or the application of area navigation based separation standards. When GNSS integrity is not assured, the following procedures must be adopted:

- a. Aircraft tracking must be closely monitored against other on-board navigation systems.
- b. The aircraft captain must advise ATS if any of the following occurs:
  - 1) during an en route phase of flight - there is RAIM loss or loss of GNSS integrity for more than 5 minutes;
  - 2) during a terminal phase of flight - there is RAIM loss or loss of GNSS integrity;
  - 3) when ATS requests the provision of GNS-derived information - RAIM or GNSS integrity is not available;
  - 4) when ATS grants a clearance or imposes a requirement based on GNSS-derived information - RAIM or GNSS integrity is not available; or
  - 5) the GNSS receiver is in dead-reckoning mode, or experiences loss of its navigation function, for more than 1 minute.

- c. If valid position information is lost, or non - RAIM operation exceeds 5 minutes, the GNSS information is to be considered unreliable and another means of navigation should be used until RAIM is restored and the aircraft is re-established on track.
- d. Following re-establishment of RAIM, the appropriate ATS unit should be notified of RAIM restoration prior to using GNSS information. This will allow ATC to reassess the appropriate separation standards.

## 5. AIR ROUTE SPECIFICATIONS

5.1 Unless otherwise authorised by ATC, when proposing to operate under the IFR on any route segments, or proposing flight in controlled airspace, the aircraft captain must plan and conduct a flight in accordance with the:

- a. route specifications published in GEN 3.2 including the relevant en route chart; and
- b. applicable flight planning requirements published in ERSA GEN; and
- c. published accessibility of airspace such as restricted areas.

5.1.1 The aircraft captain is responsible for ensuring that the requirements of [Section 4](#) can be met.

5.1.2 Where no route specification has been published in the relevant en route chart, a route determined by the aircraft captain, and, if in controlled airspace, approved by ATC, will be planned.

*Note: **ADF** - Except as provided for SPECIAL REQUIREMENTS FLIGHTS, (see [paragraph 17.1.1](#)) captains of aircraft intending to operate in civil controlled airspace shall plan flights in accordance with the established traffic flow in control areas, and via the prescribed entry and exit points. To cater for operations, exercises or other special need; routes may be planned in civil controlled airspace to meet the particular need even though not in the best interests of controlled traffic flow. These proposals are normally coordinated at command and regional level and should be published in Local Instructions.*

5.1.3 Prior ATC approval is required for area navigation tracking on routes other than those published in AIP and the Airservices Australia "Off Air Route Planning (OARP) Manual". Information and rules regarding OARP are available at:  
<http://www.airservicesaustralia.com/industry-info/flight-briefing/off-air-route-flight-planning-options/>.

5.1.4 The position reporting points for a route should be separated by a distance approximately 30MIN or 200NM apart, whichever is least, and, when practicable, should be selected from those shown on en route charts. Otherwise, the position reporting points should be places named on Airservices Australia VTC, Airservices Australia VNC, TPC, or ONC and identifiable by radio or visual means. To minimise confusion when a position is reported over a town which has a nearby aerodrome of the same name, the word 'township' must be used after the name in the text of the report.

5.1.5 For an area-type flight as distinct from route flying, the pilot of an IFR flight or VFR flight in those circumstances identified in FIHA ENR 1.10 may nominate scheduled reporting times. These should be at half-hourly intervals. The pilot must specify the area's boundaries by means of a map provided with the flight notification details.

5.1.6 An aircraft captain must make sure, by reference to the forecast, that the route selected for a VFR flight will enable the aircraft to be flown with visual reference to the ground or water for significant portions of the route, and in the vicinity of the destination aerodrome.

## 6. RADIO COMMUNICATION AND NAVIGATION REQUIREMENTS

### 6.1 Summary of Report and Broadcast Requirements

6.1.1 In this section:

- a. 'Report' means a mandatory radio report from an aircraft to the appropriate ATS unit.
- b. 'Broadcast' means a radio broadcast from an aircraft on the appropriate frequency to provide advisory traffic information to other aircraft.

6.1.2 Except in special circumstances (e.g., descent from CTA, formation flights, SAR, police/security), pilots of aircraft are required to comply with the radio communication requirements appropriate for the 'Classes of Airspace - Services and Requirements' table included in FIHA ENR 1.4 [Section 4](#).

6.1.3 In special circumstances, a pilot may request to change frequency to meet operational report, broadcast, or communication requirements. ATC will facilitate a pilot request for approval to leave a control frequency to make such reports or broadcasts. When impracticable to approve the frequency change at the time requested due to control requirements, ATC will accommodate the request as soon as possible. In determining when to make reports and broadcasts, pilots should consider the possibility of delays in being released from the ATC frequency. Requests for frequency change should specify the expected duration when the change required is not permanent.

6.1.4 After any ATS directed frequency change, pilots must advise the last assigned level and, if not maintaining the assigned level, the level maintaining or last vacated level; e.g. "MELBOURNE CENTRE (CALLSIGN) CLEARED FLIGHT LEVEL TWO ONE ZERO, LEAVING FLIGHT LEVEL TWO NINER ZERO".

*Note: The "last vacated level" may be omitted by identified aircraft squawking pressure altitude derived level information.*

6.1.5 Whenever flight rules are changed during flight (i.e. VFR to IFR or IFR to VFR), the pilot must report to ATS at the time the change takes place.

6.1.6 All aircraft departing, arriving or transiting an AFIS broadcast area during AFIS HRS must make broadcasts prior to or as soon as possible after entering the broadcast area.

6.1.7 Pilots of aircraft engaged in parachute operations must:

- a. obtain a clearance to drop when the operation is conducted in, or parachutists will enter, a Restricted or Military Operating Area or Classes A, C or D airspace. The drop clearance request must be made at least five (5) minutes before the proposed exit; and
- b. in all cases, broadcast intentions on the appropriate area VHF, and/or CTAF, two (2) minutes prior to parachutists exiting the aircraft.

6.1.8 Unless otherwise authorised, gliding operations in controlled airspace (including Class E) must be conducted using the appropriate ATC frequency.

6.1.9 Pilots of IFR flights operating outside controlled airspace who desire to establish communication with a non-ATS station and who will not be able to maintain a listening watch on the ATS frequency must advise ATS of their further SAR requirements before making the frequency change.

6.1.10 Broadcast procedures when ATS is temporarily unavailable is addressed in *Section 11*.

<b>Aircraft in Class A, B, C or D Airspace, or IFR Aircraft in Class E Airspace – Prescribed Reports</b>	
<b>Situation</b>	<b>Report</b>
Ready to Taxi	Report the situation
Airborne	Report the situation
Departure	Report the situation
Position report when required by the ATC service or the route reporting requirements in the authorised aeronautical information	Report the situation
Previously reported position estimate is more than 2 minutes in error	Corrected position estimate
Sustained variation of more than 10KT or Mach 0.02 from any previously notified speed or any standard descent profile agreed between the aircraft operator and ATS	Report the situation
Aircraft performance degraded below: <ol style="list-style-type: none"> <li>a. the level required for the airspace in which it is operating; or</li> <li>b. the capability of the aircraft reported in the aircraft's flight notification</li> </ol>	Report the situation
Leaving a level or reaching an assigned level	Report the situation
Unable to comply with ATC clearances or Instructions	Report the situation
Before leaving controlled airspace on descent	Report the situation
Arrival	If cancelling SARWATCH — report cancellation, see para 10.2.1.

<b>IFR Aircraft in Class G Airspace – Prescribed Reports</b>	
<b>Situation</b>	<b>Report</b>
Taxiing	Report the situation
Departure	Report the situation
Departure	Report the situation
Reaching cruising level	Report the situation
Position report when required by the ATC service or by the route reporting requirements of the authorised aeronautical information	Report the situation
Previously reported position estimate is more than 2 minutes in error	Report the situation
Before changing level	Report the situation
Before changing frequency	Report the situation
Requiring clearance into controlled airspace	Report the situation



IFR Aircraft in Class G Airspace – Prescribed Reports	
Before changing to CTAF and not monitoring ATS frequency on second COM system	Report the situation
After landing	If cancelling SARWATCH at this time — report the cancellation

VFR Aircraft in Class E or G Airspace — Prescribed Reports	
Situation	Report
Requiring clearance into controlled airspace	Report the situation
Before, and on completion of, over water stage	Report in accordance with SAR reporting schedules if arranged before the over water stage

Aircraft Operating in a Mandatory Broadcast Area – Mandatory Broadcasts	
Situation	Broadcast
Prior to, or immediately after entering an MBA	The pilot's intended use of the MBA
Joining a circuit	Broadcast the situation, and indicate the leg on which the aircraft will join
Conducting a straight-in approach	No later than 3NM from the runway threshold – broadcast the situation
Passing the final approach fix of an instrument approach procedure	Broadcast the situation instrument approach procedure
Commencing a missed approach	Broadcast the situation
After landing and clear of the active runway(s)	Broadcast the situation
Starting to taxi	Broadcast the situation and the following information: if the flight is to be conducted under the IFR – this information; either the: <ul style="list-style-type: none"> <li>a. planned destination aerodrome for the flight; or</li> <li>b. direction in which the pilot intends to fly from the aerodrome; or</li> <li>c. nature of operation (e.g. circuits); and</li> </ul> the runway proposed to be used for take-off.
Immediately before entering the runway to be used for take-off	Broadcast the following: a statement that the aircraft is entering the runway; and the runway identifier.

Aircraft operating in a Mandatory Broadcast Area - Mandatory Broadcasts when an SFIS is active	
Situation	Broadcast
<p><b>Taking off from an aerodrome in the MBA</b> Immediately before, or during taxiing:</p> <p><i>Note: ATS will issue an SSR code to IFR departures on first contact. Airways clearance may be issued by SFIS where aircraft performance and traffic disposition allow.</i></p>	<p>(Aerodrome) INFORMATION AND TRAFFIC</p> <ul style="list-style-type: none"> <li>• the aircraft's type and callsign; and</li> <li>• if the proposed flight is to be conducted under the IFR a statement to that effect; and</li> <li>• the name of the aerodrome, and <ul style="list-style-type: none"> <li>a. the proposed flight's intended destination; or</li> <li>b. the direction in which the pilot intends to fly from the aerodrome; or</li> <li>c. airwork intentions (e.g. circuits); and</li> </ul> </li> <li>• the runway proposed to be used for take-off.</li> </ul> <p>(Aerodrome)</p>
<p><b>Entering the runway</b> Immediately before entering the runway:</p>	<p>(Aerodrome) INFORMATION AND TRAFFIC</p> <ul style="list-style-type: none"> <li>• the aircraft's type and callsign; and</li> <li>• [BACKTRACKING] and/or (LINING UP) RUNWAY (number).</li> </ul> <p>(Aerodrome)</p>
<p><b>IFR aircraft departing the aerodrome</b> IFR departure report (non-controlled aerodromes surveillance):</p>	<p>(Aerodrome) INFORMATION AND TRAFFIC</p> <ul style="list-style-type: none"> <li>• the aircraft's type and callsign; and</li> <li>• (location reference departure aerodrome) PASSING (<i>current level</i>) CLIMBING TO (<i>intended level</i>) [ESTIMATING (<i>first reporting point</i>) AT (<i>time</i>)].</li> </ul> <p>(Aerodrome)</p>
<p><b>VFR aircraft departing the aerodrome</b> VFR departure report:</p>	<p>(Aerodrome) INFORMATION AND TRAFFIC</p> <ul style="list-style-type: none"> <li>• the aircraft's type and callsign; and</li> <li>• (location reference departure aerodrome) PASSING (<i>current level</i>) CLIMBING TO (<i>intended level</i>).</li> </ul> <p>(Aerodrome)</p>
<p><b>Changing intentions/track/level</b> When the pilot intends to alter track and/or level given in a previous broadcast of intentions:</p>	<p>(Aerodrome) INFORMATION AND TRAFFIC</p> <ul style="list-style-type: none"> <li>• the aircraft's type and callsign; and</li> <li>• the aircraft's position; and</li> <li>• the aircraft's present level; and</li> <li>• the pilot's intentions in relation to the flight.</li> </ul> <p>(Aerodrome)</p>
<p><b>Flying through an MBA where SFIS is active without landing</b> The pilot in command of an aircraft intending to fly through the area without landing must, prior to or as soon as possible after the aircraft enters the MBA, make a broadcast that includes the following information:</p>	<p>(Aerodrome) INFORMATION AND TRAFFIC</p> <ul style="list-style-type: none"> <li>• the aircraft's type and callsign; and</li> <li>• the aircraft's position; and</li> <li>• the aircraft's present level; and</li> <li>• the pilot's intentions in relation to the flight.</li> </ul> <p>(Aerodrome)</p>

<b>Aircraft operating in a Mandatory Broadcast Area - Mandatory Broadcasts when an SFIS is active</b>	
<p><b>Landing at an aerodrome in the MBA</b> The pilot in command of an aircraft intending to land at an aerodrome in the MBA, must prior to or as soon as possible after the aircraft enters the MBA, make a broadcast that includes the following information:</p>	<p>(Aerodrome) INFORMATION AND TRAFFIC</p> <ul style="list-style-type: none"> <li>• the aircraft's type and callsign; and</li> <li>• the aircraft's radial, bearing or quadrant from, and distance from, the aerodrome at which the pilot proposes to land; and</li> <li>• the aircraft's altitude; and</li> <li>• the pilot's intentions in relation to the flight.</li> </ul> <p>(Aerodrome)</p>
<p><b>Entering the circuit</b> If and when the aircraft joining the circuit, make a broadcast that consists of:</p>	<p>(Aerodrome) INFORMATION AND TRAFFIC</p> <ul style="list-style-type: none"> <li>• the aircraft's type and callsign; and</li> <li>• a statement that the aircraft is joining the circuit; and</li> <li>• the leg on which the aircraft is joining the circuit; or if the pilot intends to make a straight in approach to the landing runway, make a prior broadcast of that intention.</li> </ul> <p>(Aerodrome)</p>
<p><b>Vacating the runway</b> The aircraft is clear of the active runway(s): <i>Note: For IFR aircraft, this would normally be accompanied with request to cancel SARWATCH.</i></p>	<p>(Aerodrome) INFORMATION AND TRAFFIC</p> <ul style="list-style-type: none"> <li>• the aircraft's callsign; and</li> <li>• broadcast and report to ATS once established outside the runway strip using the radio telephony 'RUNWAY [number] VACATED'.</li> </ul> <p>(Aerodrome)</p>
<p><b>Operations complete</b> For operations that are not associated with or restricted to runways, when operations within the MBA are complete:</p>	<p>(Aerodrome) INFORMATION AND TRAFFIC</p> <ul style="list-style-type: none"> <li>• the aircraft's callsign; and</li> <li>• OPERATIONS COMPLETE.</li> </ul> <p>(Aerodrome)</p>

ENR 1.1

**6.2 Inoperative Radio and No Radio Procedures**

6.2.1 This section from Airservices Australia AIP not applicable to ADF.

6.2.2 A non-radio aircraft may fly in Class G airspace in VMC by day at or below 5,000FT AMSL.

6.2.3 If total or partial failure of the required radio communications equipment occurs before flight commences and repair facilities are available, repairs must be made before the flight proceeds.

6.2.3.1 Where repair facilities are not available, flight to the nearest appropriate repair facility may proceed in Class G airspace in VMC only. If flight to the nearest appropriate repair facility entails flight in controlled airspace, the flight may proceed provided that ATS is advised of the radio failure and a clearance for the flight is obtained from ATC.

6.2.3.2 When arriving at a non-controlled aerodrome where the carriage of radio is required, if a radio failure occurs either en route to or in the circuit of the aerodrome, the pilot may continue to land at that aerodrome provided:

- a. where equipped - the aircraft displays its external lights, and its transponder is turned on; and
- b. if en route - the pilot uses the overfly joining procedure (Refer to the graphic at paragraph 9.12.6).

6.2.3.3 A pilot may depart the aerodrome with an unserviceable radio and fly to another aerodrome for repairs, provided that the aircraft - where equipped - displays its external lights and its transponder is turned on.

6.2.3.4 To maximise the safety of commercial passenger transport operations, during a flight to or from an aerodrome for radio repairs, it is requested that pilots plan to avoid arriving or departing from an aerodrome during the known hours of scheduled air transport operations. For aerodromes where there is a UNICOM or CA/GRS, pilots should by alternative means where possible make contact and advise their intentions before conducting operations.

6.2.3.5 An aircraft not equipped with an operative radio may operate at, or in the vicinity of a non-controlled certified or military aerodrome provided that:

- a. the aircraft is operated in VMC by day; and
- b. the aircraft arrives or departs in the company of another radio-equipped aircraft that is flown by a radio-qualified pilot which will allow the latter to make radio calls on behalf of both aircraft.

*Note: The radio-equipped aircraft should be manoeuvred to keep the no radio aircraft at a safe distance and in sight at all times in order to accurately report its position.*

6.2.4 Procedures to be adopted when total loss of radio occurs whilst in-flight and within Australian Domestic airspace are contained in ERSA EMERG. (For radio failure or no radio procedures at all non-controlled aerodromes refer ERSA INTRO).

6.2.5 Procedures to be adopted when total loss of radio occurs whilst in-flight and within Australian administered Oceanic airspace are as follows:

6.2.6 In the event of total loss of communication, an aircraft shall:

- a. try to re-establish communication by all other means;
- b. if all attempts to re-establish communication with ATC are unsuccessful:
  - 1) Squawk 7600;
  - 2) If able, broadcast in the blind at suitable intervals: aircraft identification, flight level, aircraft position (including the ATS route designator or the track code), and intentions on the frequency in use, as well as on frequency 121.5 MHZ (or as a back-up, the VHF inter-pilot air-to-air frequency 123.45 MHZ).
  - 3) Watch for conflicting traffic both visually and by reference to airborne collision avoidance systems or traffic displays (if equipped);
  - 4) Turn on all aircraft exterior lights (commensurate with appropriate operating limitations);
  - 5) Maintain the last assigned speed and level for a period of 60 minutes following the aircraft's failure to report its position over a compulsory reporting point (including ADS-C flights), and thereafter adjust speed and altitude in accordance with the filed flight plan;

*Note: In OCA, aircraft experiencing communication failure may also initiate strategic lateral offset procedures (SLOP) in accordance with ENR 2.2 para 2.2, including an offset of up to 2 NM right of track.*

- 6) Upon exiting OCA, conform to the relevant State procedures and regulations.

6.2.7 In the event of lost communication, ATC shall maintain separation between the aircraft having the communication failure and other aircraft, based on the assumption that the aircraft having the communication failure will operate in accordance with the procedures in paragraph 6.2.6.

### 6.3 GNSS Reporting Requirements and Procedures

6.3.1 **ADF** - GNSS systems used to provide distance information to ATS units by pilot reports must meet one of the GNSS equipment specifications mentioned in GEN 1.5 section 2.

6.3.2 ATC may apply some DME-based separation standards to approved aircraft providing GNSS distance information. Pilots must be familiar with and comply with GNSS reporting requirements and procedures.

6.3.3 When a DME distance is not specifically requested, or when the provision of a DME distance is not possible, distance information based on GNSS-derived information may be provided. When responding to ATC requests for distance information, pilots should:

- a. provide either a DME distance or a GNSS distance unless RAIM is currently not available, and has been unavailable for the previous 5 minutes; and
- b. include the source and point of reference; e.g. 115 GNSS Melbourne, 79 DME Newman, 257 GNSS BEEZA, etc.

6.3.4 Notwithstanding [paragraph 6.3.3](#), if an ATC unit has issued a clearance or restriction based upon GNSS distance (e.g. a restriction to reach a certain level by a GNSS distance), pilots must inform ATC if RAIM is not available.

6.3.5 If a GNSS distance is provided to an ATC unit, and RAIM is not currently available, but has been available in the preceding 5 minutes, the distance report should be suffixed "NEGATIVE RAIM" e.g. 26 GNSS LT VOR, NEGATIVE RAIM.

6.3.6 Databases sometimes contain waypoint information which is not shown on published AIP charts and maps. Distance information must only be provided in relation to published waypoints unless specifically requested by an ATS unit.

6.3.7 Where GNSS distance is requested or provided from an NDB, VOR, DME, or published waypoint, the geographical coordinates of the navigation aid or waypoint must be derived from a validated data-base which cannot be modified by the operator or crew.

**7. LAND AND HOLD SHORT OPERATIONS (LAHSO)**

**7.1 Introduction**

7.1.1 Notwithstanding the provisions of [paragraph 2.12.6.2](#) and [2.12.6.3](#), operations by an aircraft landing on one runway and another aircraft either taking off or landing simultaneously on a crossing runway may be permitted subject to the provisions of this section.

**7.2 Locations Where LAHSO are Used**

7.2.1 LAHSO can be implemented at aerodromes controlled by ATC that have suitable runway configurations, together with taxi markings, signs, runway markings, and lights in accordance with the standards in FIHA AD 1.1 [paragraph 4.11.4](#), [4.15.1 e](#), [4.16.1 d](#), and [5.14.9](#).

7.2.2 LAHSO aerodromes are indicated in ERSA by the inclusion in the aerodrome information of a table titled "LDA FOR LAHSO".

**7.3 A Dependent Procedure**

7.3.1 LAHSO are to be considered dependent procedures, with participating aircraft classified as either:

- a. active - when an aircraft is issued a hold short requirement and is alerted about traffic on a crossing runway; or
- b. passive - when an aircraft has unrestricted use of the full runway length and is alerted about traffic on a crossing runway.

**7.4 Participation**

7.4.1 Active participation in LAHSO is available to pilots in each of the following categories:

- a. pilots of Australian registered aircraft of performance categories A, B or C engaged in operations conducted under a training and checking organisation, subject to the operator providing information in their operational document suite and certifying participating pilots for LAHSO;
- b. pilots of Australian registered aircraft of performance category A, B or C where the pilot has been assessed as competent to conduct LAHSO by a person authorised to conduct LAHSO training;
- c. ATC will consider all Australian registered aircraft, operating on a flight number callsign, to be approved active participants, unless advised to Air Traffic Services as not able to be an active and/or passive participant;
- d. pilots of Australian military aircraft in performance categories A, B or C; and
- e. pilots of foreign military aircraft in performance categories A, B or C subject to a Letter of Agreement between the relevant military authority and the ATS provider.

7.4.2 Passive participation in LAHSO is available to pilots in each of the following categories:

- a. pilots of Australian civil and military aircraft categories A, B and C at pilot discretion;
- b. pilots of other civil aircraft, including foreign operators, as approved by CASA;
- c. pilots of RAAF Hawk, FA18 and other Australian military aircraft as approved by the relevant Operational Airworthiness Authority;

- d. **ADF** - P-8A and C-17A approved for passive LAHSO at RAAF Base Darwin;
- e. pilots of foreign military aircraft approved by Defence, operating at Defence aerodromes, subject to a Letter of Agreement; and
- f. pilots of foreign military aircraft subject to a Letter of Agreement between the relevant military authority and the civil ATS provider. (The Letter of Agreement will exclude foreign military aircraft of performance category D operating at civil aerodromes).

7.4.3 This paragraph from Airservices Australia AIP not applicable to ADF.

7.4.4 A pilot must not accept a requirement to "HOLD SHORT" unless they are qualified, has situation awareness, and has determined that the LDA is adequate for the prevailing conditions and the status of the aircraft.

7.4.5 Operators of aircraft in any category may elect not to allow their pilots to participate in LAHSO. In these cases, ATS should be advised in writing, specifying the company's withdrawal from active, passive, or both modes of participation.

*Note: This notification should be emailed to Airservices: [atsintegrity@airservicesaustralia.com](mailto:atsintegrity@airservicesaustralia.com) and/or 44WG: [hqsrqa7.anspstand@defence.gov.au](mailto:hqsrqa7.anspstand@defence.gov.au)*

### 7.5 Conditions for LAHSO

7.5.1 LAHSO may be conducted subject to the following conditions:

- a. The wind for either the active or passive runway, including gusts, does not exceed:
  - 1) 20KT crosswind;
  - 2) 5KT tailwind on a dry runway;
  - 3) no tailwind when the runway is not dry.
- b. A simultaneous take-off and landing is permitted by day only.
- c. Simultaneous landings are permitted by day and night.
- d. The ceiling is not less than the minimum vectoring altitude (MVA) for the location where LAHSO are being conducted and visibility is not less than 8KM.
- e. Visibility may be reduced to 5000M where ATC are assured of sighting the aircraft prior to a loss of the surveillance standard.
- f. Advice to departing aircraft may be given separately from the take-off clearance.
- g. Instructions are issued to prevent a landing aircraft from crossing the Hold-Short Line when the intersecting runway is being used by another aircraft.
- h. The distance from the landing threshold to the Hold-Short Line of the intersecting runway is adequate for the performance category of the aircraft being held short.
- i. ERSA Aerodromes and Facilities (FAC) and/or Runway Distance Supplement (RDS) show "LDA for LAHSO" information. Pilots must ensure that the aeroplane can land safely within the LDA for LAHSO.
- j. If a runway is reported as WET, the braking characteristics must have been assessed as GOOD by the pilot of an aircraft in the same performance category prior to the landing aircraft being instructed to hold short. ATC will request pilot assessments of the braking characteristics hourly where weather conditions are deteriorating or remain unchanged.
- k. The landing aircraft will not be instructed to hold short when low level wind shear is reported.
- l. For active participants ground based visual or electronic glide slope guidance must be available and utilised.

*Note: This requirement does not apply to performance category A and B non-jet aircraft of less than 5700KG MTOW landing Runway 36 at Darwin.*

- m. After landing, the pilot must inform ATC immediately of any difficulty in complying with the ATC requirement to hold short of a crossing runway strip.

### 7.6 Pilot Advice of LAHSO Approval

7.6.1 ATC will not intentionally issue, and a pilot must not accept, a clearance for a hold-short landing unless the pilot is LAHSO approved. Pilots who elect to participate actively in LAHSO must obtain the ATIS broadcast as early as possible and if within 200NM of destination where LAHSO is in progress, immediately

advise ATC "LAHSO APPROVED".

e.g. "MELBOURNE CENTRE, (call-sign) DESCENDING TO FLIGHT LEVEL TWO FIVE ZERO, LAHSO APPROVED".

7.6.2 Pilots of civil aircraft operating under a flight number callsign as advised in flight notification, and pilots of Australian military aircraft, may omit the words "LAHSO APPROVED". Aircraft of operators who have advised in writing an intention not to participate will not be intentionally sequenced for LAHSO. Where an aircraft or crew that would normally participate actively or passively in LAHSO does not meet the criteria for participation, this must be communicated to ATS at the earliest opportunity.

7.6.3 Pilots of aircraft not operating under a flight number callsign who will be entering controlled airspace within 120NM of destination must advise ATC "LAHSO APPROVED";

7.6.4 When crews experience wind shear, early advice to ATC is essential to ensure timely information is passed to subsequent aircraft.

### 7.7 ATIS Broadcast

7.7.1 Pilots will be alerted that LAHSO are in progress by a statement on the ATIS;

e.g. "DARWIN TERMINAL INFORMATION BRAVO, RUNWAYS 29 AND 36, LAND AND HOLD SHORT OPERATIONS IN PROGRESS, (wind, temperature, etc.)".

7.7.2 Both the active and passive runways will be nominated on the ATIS to aid in crew situational awareness.

*Note: The acronym LAHSO may be used at ATC discretion.*

### 7.8 Directed Traffic Information

7.8.1 ATC is required to issue directed traffic information to both aircraft participating in LAHSO.

### 7.9 Readback Requirements

7.9.1 In all cases, pilots must readback an ATC-issued requirement to hold short.

### 7.10 Landing Distance Assessments

7.10.1 ATC will normally sequence an aircraft for a runway which requires LAHSO only when the landing distance available for the aircraft is likely to be adequate in accordance with aircraft landing category criteria held by ATC.

7.10.2 ATC may sequence non-jet Category B aircraft below 5,700KG MTOW for LAHSO using the landing distance available from ERSA. ATC may sequence an aircraft for LAHSO regardless of category of aircraft where the aircraft captain has advised "LAHSO APPROVED". The pilot alone is responsible for ensuring that the LDA is equal to, or better than, that required for the prevailing circumstances.

7.10.3 Pilots should check the ERSA entry or ask ATC for landing distance available, and assess their landing distance requirements based on the landing weight and ambient weather conditions. The pilot must ensure that the LDA for LAHSO value for the runway meets or exceeds the relevant landing distance required for their particular flight and operation.

### 7.11 Go Around During LAHSO

7.11.1 It is important for pilots to plan for action in the event of a go around. If a go around does occur, pilots must maintain safe separation from other aircraft, as it may be impractical for ATC to provide standard separation. Nevertheless, ATC will issue traffic information and, if appropriate - based on the relative position of aircraft, instructions for avoiding other aircraft.

7.11.2 When issued with avoiding action instructions, pilots should fly the specified heading without delay.

7.11.3 Regardless of any avoiding action instructions, pilots should always defer to any TCAS RA.

## 8. VERTICAL SEPARATION IN THE AUSTRALIAN FIR

### 8.1 Reduced Vertical Separation Minimum (RVSM)

#### 8.1.1 Application of RVSM

8.1.1.1 Australia applies a 1,000FT reduced vertical separation minimum between approved aircraft operating between FL290 and FL410 inclusive.

8.1.1.2 RVSM does not apply to formation flights and civil formation flights will not be issued clearance to operate between FL290 and FL410 inclusive.

#### 8.2 RVSM Operations

8.2.1 Aircraft transiting from adjacent FIRs into Australian FIRs between FL290 and FL410 inclusive must plan from the waypoint on the FIR boundary using the table of cruising levels at ENR 1.7 [Section 5](#).

8.2.2 Aircraft transiting from Australian FIRs between FL290 and FL410 inclusive to adjacent FIRs must plan until the waypoint on the FIR boundary using the table of cruising levels at ENR 1.7 [Section 5](#).

8.2.3 Aircraft that will cross latitude 80°S between FL290 and FL410 inclusive must plan using the table of cruising levels at ENR 1.7 [Section 5](#) for operations north of 80°S, and the table of cruising levels at ENR 1.7 [Section 6](#) for operations south of 80°S.

8.2.4 To have RVSM applied to their aircraft, operators must be approved by the State of Registry or State of the Operator.

8.2.5 Approved operators must ensure that height-keeping monitoring is undertaken at least every two years or within intervals of 1,000 flight hours per aircraft, whichever period is longer, in accordance with the aircraft categories as presented in the current version of the ICAO RVSM Minimum Monitoring Requirements table. The table and further information on monitoring can be obtained from the Australian Airspace Monitoring Agency (AAMA) at [www.airservicesaustralia.com/organisations/aama/](http://www.airservicesaustralia.com/organisations/aama/).

8.2.6 Pilots of aircraft that are not RVSM-approved may plan within the RVSM flight level band (FL290 to FL410 inclusive). However, clearance at RVSM levels is subject to disposition of traffic and RVSM aircraft priority. The conventional vertical separation minimum will be applied between aircraft that are not RVSM-approved and all other aircraft.

8.2.7 Pilots of non RVSM-approved State aircraft will be afforded equal priority with RVSM-approved aircraft. Pilots planning to operate non-RVSM within the RVSM level band must flight plan in accordance with FIHA ENR 1.10 paragraph 3.4.

8.2.8 Pilots of aircraft that are not RVSM-approved must report "NEGATIVE RVSM" in accordance with the requirements of *GPA GEN 3.4 sub section 6.6 Item 2.q*.

### 8.3 Operational Procedures Before Entering the RVSM Flight Level Band - RVSM Approved Aircraft

8.3.1 On each flight before entering the RVSM flight level band, pilots of RVSM-approved aircraft must check to ensure that all of the following minimum mandatory equipment is operating normally:

- a. two independent primary altimetry systems,
- b. a Mode C-capable SSR transponder,
- c. an altitude alert system, and
- d. an autopilot with height lock.

8.3.2 If any item of the minimum mandatory equipment listed in [paragraph 8.3.1](#) is not operating normally, a pilot must notify ATC before entering the RVSM flight level band using the phraseology "NEGATIVE RVSM" (see *GPA GEN 3.4 sub section 6.6 Item 2.q*).



**8.4 Operational Procedures After Entering the RVSM Flight Level Band -  
RVSM Approved Aircraft -**

8.4.1 During changes of level, an aircraft must not overshoot or undershoot its Cleared Flight Level (CFL) by more than 150FT (45M).

8.4.2 **Failure of one primary altimetry system.** If one of the primary altimetry systems fails, but the remaining altimetry system is functioning normally, the pilot must:

- a. couple that system to the autopilot with height lock;
- b. maintain increased vigilance of altitude-keeping; and
- c. notify ATC of the failure using the phraseology, "FOR INFORMATION, OPERATING ON ONE PRIMARY ALTIMETER ONLY".

8.4.3 **Failure of all primary altimetry systems.** If all primary altimetry systems fail, or are considered unreliable, the pilot must:

- a. maintain the flight level indicated on the standby altimeter (if the aircraft is so equipped) at the time of failure or when considered unreliable;
- b. alert nearby aircraft by turning on all exterior lights and, if not in VHF contact with ATC, by broadcasting advice of the failure, position, flight level, and intentions on 121.5 MHZ;
- c. notify ATC of the failure using the phraseology "NEGATIVE RVSM" (see *GPA GEN 3.4 sub section 6.6 Item 2.q.*) and the intended course of action.

8.4.4 **In Oceanic Class A Airspace.** If unable to obtain ATC clearance in a timely manner following a failure of all primary altimetry systems in Oceanic Class A airspace, the pilot must proceed as follows:

- a. If operationally feasible to do so, leave the assigned route or track by turning at least 45° right or left, whenever this is possible, taking account of adjacent routes and descend below FL290.
- b. If not operationally feasible to execute this contingency procedure, continue to alert nearby aircraft and coordinate with ATC.

8.4.5 **Divergence in primary altimetry system's indication.** If the primary altimeters diverge by more than 200FT, the pilot must proceed as follows:

- a. Attempt to determine the defective system through established "trouble-shooting" procedures and/or comparing the primary altimeter displays to the standby altimeter (as corrected by correction card, if required).
- b. If the defective system can be determined, couple the functioning altimetry system to the autopilot with height lock and proceed as in [paragraph 8.4.2](#).
- c. If the defective system cannot be determined, proceed as in [paragraph 8.4.3](#).

8.4.6 **Failure of the Mode C-capable SSR transponder.** If the mode C-capable transponder fails, the pilot must notify ATC of the failure using the phraseology "NEGATIVE RVSM" (see *GPA GEN 3.4 sub section 6.6 Item 2.q.*).

8.4.7 **Failure of the Altitude Alert System.** If the altitude alert system fails, the pilot must notify ATC of the failure using the phraseology "NEGATIVE RVSM" (see *GPA GEN 3.4 sub section 6.6 Item 2.q.*).

8.4.8 **Failure of the Autopilot with Height Lock.** If the autopilot with height lock fails, the pilot must initiate the following actions sequentially:

- a. Maintain CFL.
- b. Evaluate the aircraft's capability to maintain altitude through manual control.
- c. Assess the situation regarding possible conflicting traffic.
- d. Alert nearby aircraft by turning on all exterior lights and, if not in VHF contact with ATC, broadcast advice of failure, position, flight level, and intentions on 121.5 MHZ.
- e. Notify ATC of the failure using the phraseology "NEGATIVE RVSM" (see *GPA GEN 3.4 sub section 6.6 Item 2.q.*) and the intended course of action.

8.4.9 **In Oceanic Class A Airspace.** Possible courses of action for the pilot following a failure of the autopilot with height lock in Oceanic Class A airspace include the following:

- a. Provided that the aircraft can maintain CFL, continue at that level.
- b. If the aircraft cannot maintain CFL and is unable to obtain a revised ATC clearance, leave the assigned route or track by turning 90° right or left, whenever this is possible, taking account of adjacent routes.

### 8.5 ATC Responsibilities

8.5.1 ATC will apply alternative separation to any aircraft that has reported "NEGATIVE RVSM" in accordance with requirements specified in this Section.

### 8.6 Weather and Wake Turbulence, and System Alerts

8.6.1 The pilot of an aircraft operating within the RVSM flight level band that encounters weather turbulence that affects aircraft capability to maintain CFL, or wake turbulence, or experiences distracting aircraft system alerts, must notify ATC and request a revised clearance before deviating from track or CFL.

8.6.2 **Oceanic Control Area (OCA) only.** If a revised clearance is not possible or practicable, the an aircraft operating in OCA may initiate the following temporary lateral offset procedure with the intention of returning to the cleared route as soon as possible:

- a. If possible, establish contact with other aircraft on the VHF inter-pilot air-to-air frequency 123.45 MHZ.
- b. Initiate a lateral offset (one or both aircraft may initiate) not to exceed 2NM from the cleared route or track, provided that:
  - 1) as soon as practicable, the pilot(s) of the offsetting aircraft notify ATC that temporary lateral offset action has been taken and the reason for doing so; and
  - 2) the pilot(s) of the offsetting aircraft notify ATC when the aircraft is re-established on the assigned route(s) or track(s).

### 8.7 Flight Level Deviation Reporting

8.7.1 For operations in the Australian FIR, flight crews must report all flight level deviations of 300FT or more from the aircraft's assigned level, irrespective of the cause of the deviation.

In reporting, crews must provide the information in the format detailed in [paragraph 8.7.3](#). Reports must be submitted as soon as possible after the occurrence and in writing to:

Australian Airspace Monitoring Agency (AAMA)  
Airservices Australia  
GPO Box 367  
CANBERRA ACT 2601  
AUSTRALIA  
E-mail: [aama@airservicesaustralia.com](mailto:aama@airservicesaustralia.com)  
FAX: +61 2 6268 5695

8.7.2 Flight crew may send reports through the airline/operator using its normal reporting procedures.

8.7.3 A report of altitude deviations of 300FT or more, including those due to Traffic Alert and Collision Avoidance System (TCAS), turbulence, and contingency events must use the following format:

- a. Reporting Agency;
- b. Date and Time;
- c. Location of Deviation: (Latitude/Longitude) and indication of the area (e.g., Australian South Pacific airspace/Australian Continental airspace/Australian Indian Ocean airspace);
- d. Aircraft Identification and Type;
- e. Flight Level Assigned;
- f. Observed/Reported (indicate one) Final Flight Level: and indicate whether controller or pilot report;
- g. Duration at Flight Level;
- h. Cause of Deviation;
- i. Other traffic;
- j. Crew Comments: (if provided);
- k. Remarks: (If the event necessitated contingency action, indicate whether GPA/FIHA contingency procedures were followed).

## 9. OPERATIONS IN CLASS G AIRSPACE

### 9.1 Communications

9.1.1 ADF - The pilot of an IFR aircraft in class G airspace must attempt to contact ATS on VHF or HF when taxiing. If the pilot is unable to make contact with the air traffic service during taxi, the flight may taxi and take-off provided contact is established as soon as possible after take-off, and a SARTIME for departure, that is a maximum of 30 minutes after commencing to taxi has been established with air traffic services.

*Note: Pilots are reminded of their obligations to see and avoid other aircraft and their responsibility for collision avoidance in the vicinity of non-controlled aerodromes using 'see-and-avoid'.*

9.1.2 The pilot of an IFR flight departing from a non-controlled aerodrome must report "IFR" when making first contact with ATS.

9.1.3 A pilot operating in accordance with *paragraph 9.1.1(b)* may nominate a SARTIME for departure either as part of the arrival report or when submitting flight notification by the phrase "SARTIME FOR DEPARTURE". SAR alerting action will be initiated if a report is not received by the nominated SARTIME for departure.

9.1.4 ADF - To achieve the greatest degree of safety requires pilots of aircraft carrying a serviceable radio which they are qualified to use are to make a broadcast whenever it is reasonably necessary to do so to avoid a collision, or the risk of a collision with another aircraft at a non-controlled aerodrome.

*Note: Pilots are reminded of their obligations to see and avoid other aircraft and their responsibility for collision avoidance in the vicinity of non-controlled aerodromes using 'see-and-avoid'.*

9.1.5 In Class G airspace, pilots of radio-equipped VFR aircraft should monitor the appropriate VHF frequency and announce if in potential conflict. Pilots intercepting broadcasts from aircraft which are considered to be in potential conflict must acknowledge by transmitting own callsign and, as appropriate, aircraft type, position, actual level and intentions.

9.1.6 For para 9.1.5, the appropriate VHF frequency is:

- a. when operating in the vicinity of an aerodrome published on aeronautical charts - the CTAF (MULTICOM 126.7MHz or the discrete frequency as published); or
- b. when operating within a Broadcast Area - the Broadcast Area CTAF.

Otherwise, it is recommended pilots use the Area VHF. This frequency may provide the best means of gaining assistance from ATC or other pilots in the event of an emergency.

9.1.7 In the vicinity of uncharted aerodromes, pilots have discretion to use the most appropriate frequency that ensures safe operation. This may be 126.7MHz. However, pilots should be aware that transiting aircraft will be monitoring Area VHF. To ensure mutual traffic awareness, it is recommended that pilots using an alternative frequency also monitor Area VHF.

9.1.8 It is required (unless operating in accordance with procedures in the *Part 103 MOS*) that gliders operating above 5,000FT in Class G airspace monitor the Area VHF. An aircraft is considered in the vicinity of a non-controlled aerodrome if it is within 10NM of the aerodrome and at a height above the aerodrome that could result in conflict with operations at the aerodrome.

**PARKES**  
AVFAX CODE 2137

ELEV 1069

NSW  
S 33 07.9 E 148 14.3 UTC +10  
AD OPR Parkes Shire Council, PO Box 337, Parkes, NSW  
2870. Council PH 02 6861 2333; FAX 6862 3946, FAX 6862 1710, ARO 0427 282 062.

YPKS  
CERT

**radio carriage MANDATORY**  
at all CERT, REG, MIL aerodromes

**REMARKS**

- AD Charges: ACFT BLW ABV 2000KG - \$7.20/ton
- This AD is a Security Controlled Airport.
- Parkes Radio Telescope - Aircraft Exclusion Zone exists 1NM radius around and 5,000FT ceiling above the telescope. R525 is 12NM N of Parkes aerodrome.

---

**NOOSA**

QLD  
S 26 25.4 E 153 03.8  
AD OPR Noosa Helicopters and Hanger Services Pty Ltd., PO Box 4, Noosaville, QLD, 4566, PH 07 5442 4451.

**REMARKS**

- Restricted OPS. PVT, PPR from AD OPR.
- AD Charges: All ACFT.

**ATS COMMUNICATIONS FACILITIES**

FIA BRISBANE CENTRE 129.0 Circuit Area

CTAF 126.7

**CHARTS RELATED TO THE AERODROME**

WAC 3340

ELEV 3

FULL NOTAM SERVICE NOT AVBL  
UTC +10  
VAR 11 DEG E

YNSH  
UNCR

**radio carriage NOT MANDATORY**  
at UNCR aerodromes unless required by the aerodrome operator or designated by CASA.

9.1.9 Pilots of aircraft transiting in the vicinity of a non-controlled aerodrome should avoid flying over the aerodrome at an altitude that could conflict with operations in the vicinity of the aerodrome.

9.1.10 When a report from an IFR aircraft is made to FLIGHTWATCH on HF, a broadcast on the appropriate CTAF or Area VHF is also required.

9.1.11 If calls are not made clearly and concisely using the standard phraseology, confusion can arise at aerodromes in close proximity that share the same CTAF.

9.1.12 The standard broadcast format is:

- a. {Location} Traffic
- b. {Aircraft type}
- c. {Callsign}
- d. {Position/level/intentions}
- e. {Location}

9.1.13 The following tables provide a summary of recommended broadcasts to be made when operating or arriving at, or departing from, a non-controlled aerodrome. Pilots should also observe local and published noise abatement procedures and curfews.

Recommended Calls In All Circumstances	
Situation	Broadcast
The pilot intends to take-off	Immediately before, or during taxiing

Recommended Calls In All Circumstances	
The pilot is inbound to an aerodrome	10NM from the aerodrome, or earlier, commensurate with aeroplane performance and pilot workload, with an estimated time of arrival (ETA) for the aerodrome
The pilot intends to fly through the vicinity of, but not land at, a non-controlled aerodrome	10NM from the aerodrome, or earlier, commensurate with aeroplane performance and pilot workload, with an estimated time of arrival

Recommended Calls Dependent On Traffic	
Situation	Broadcast
The pilot intends to enter a runway	Immediately before entering a runway
The pilot is ready to join the circuit	Immediately before joining the circuit
The pilot intends to make a straight-in approach	On final approach at not less than 3NM from the threshold (see note)
The pilot intends to join on base leg	Prior to joining on base
During an Instrument Approach when: a. departing FAF or established on final approach segment inbound b. terminating the approach, commencing the missed approach	Including details of position and intentions that are clear to all pilots (both IFR and VFR)
The aircraft is clear of the active runway(s)	Once established outside the runway strip

*Note: Some distances above refer to the runway threshold and others to the ARP. Pilots should be aware that a GNSS indication of 3NM from an aerodrome may not be 3NM to the runway threshold.*

9.1.14 **ADF** - For all Defence flights, the aircraft captain must provide ATS with the number of POB on first contact with ATS on taxi or departure from a non-controlled aerodrome.

**9.2 Circuit Information**

9.2.1 Pilots should fly a circuit commensurate with the aircraft type they are operating. However the use of any circuit procedure does not alter the responsibility of each pilot to see and avoid other aircraft. Pilots operating in the circuit should manoeuvre to follow traffic ahead of them in the circuit.

9.2.2 Left-hand circuits is the standard traffic circuit that must normally be made. Right-hand circuit requirements are listed in ERSA.

9.2.3 Aircraft should not be operated in the circuit at an indicated airspeed of more than 200KT.

9.2.4 **ADF** - During the initial climb-out the turn onto crosswind should be made appropriate to the performance of the aircraft, but in any case not less than 500FT so as to be at circuit height when turning downwind. Exceptions to this requirement include:

- a. to avoid an obstacle or terrain; or
- b. to avoid undue noise over a populated area without compromising the aircraft's safety; or
- c. for a single engine seaplane or amphibian--to enable the aircraft to land on water if its engine fails.

9.2.5 Pilots may vary the size of the circuit depending on:

- a. the performance of the aircraft;
- b. safety reasons; or
- c. in accordance with the Aircraft Flight Manual, Pilot's Operating Handbook, or company Standard Operating Procedures.

9.2.6 Pilots are encouraged to turn on aircraft landing lights, anti-collision lights and strobe lights, where fitted, when in the vicinity of a non-controlled aerodrome, until the aircraft has landed.

9.2.7 Transponders can be detected by aircraft equipped with ACAS (TCAS), allowing them to 'see' other aircraft and take evasive action. Pilots of transponder-equipped aircraft should at all times ensure their transponder is switched to ON/ALT (Mode C), including when operating in the vicinity of a non-controlled aerodrome. In the event of a radio failure it is important that pilots select 7600 on their transponder and continue squawking.

9.2.8 So as not to impede commercial aviation, pilots flying recreational or sport aircraft for their own enjoyment, or pilots flying GA aircraft for their own leisure, should consider giving way to aircraft being used for 'commerce' provided that the inconvenience to their own operation is not great and it can be done safely. Operators of commercial aircraft should never expect a give way offer to be assumed or automatic. Any offer to give way must be explicit and its acceptance acknowledged.

### 9.3 Separation Minima for Take-off

9.3.1 An aircraft must not commence take-off until:

- a. a preceding departing aircraft using the same runway has:
  - 1) crossed the upwind end of the runway; or
  - 2) commenced a turn; or
  - 3) if the runway is longer than 1,800M, become airborne and is at least 1,800M ahead; or
  - 4) if both aircraft have a MTOW below 2,000KG, the preceding aircraft is airborne and is at least 600M ahead;
- b. a preceding landing aircraft using the same runway, has vacated it and is taxiing away from the runway;
- c. a preceding aircraft, using another runway, has crossed or stopped short of the take-off aircraft's runway.

9.3.2 At aerodromes where gliders operate to a common circuit pattern from a parallel strip outside the runway strip, the above separation minima shall apply to aircraft landing or taking off on either runway as if they were a single runway, but aircraft taxiing or stationary on the runway must not affect operations on the other.

9.3.3 Where gliders and glider tugs operate to a contra-circuit, simultaneous operations are permitted.

### 9.4 Circuit Height

9.4.1 When operating at non-controlled aerodromes, the following circuit heights are recommended:

- a. High performance - includes jets and many turbo-prop aircraft, above approximately 150KT - 1500FT AGL;
- b. Medium performance - includes most piston engine aircraft, between approximately 55KT and 150KT - 1000FT AGL;
- c. Low performance - ultralights and rotary wing with a maximum speed of approximately 55KT - 500FT AGL (Refer diagram at [sub-section 9.12](#)).

9.4.2 Circuit heights for aerodromes which have specific requirements are published in ERSA.

### 9.5 Taxiing

9.5.1 Pilots of IFR flights operating from non-controlled aerodromes must report to ATC on taxiing. If unable to establish contact, proceed in accordance with [paragraph 9.1.1](#).

9.5.2 Taxiing reports for IFR flights must include the following information:

- a. aircraft type;
- b. POB (for flights other than air transport operations);
- c. IFR;
- d. location;
- e. destination or departure quadrant or intentions; and
- f. runway to be used.

9.5.3 Following the taxi report, a pilot of an IFR flight must report to ATC if changing to a CTAF or Broadcast Area CTAF when the ATS frequency will not, or cannot, be monitored. This report must include the aerodrome location and frequency.

**9.6 Departure Information**

9.6.1 Pilots of departing aircraft should depart by extending one of the standard circuit legs. An aircraft should not execute a turn opposite to the circuit direction unless the aircraft is well outside the circuit area and no traffic conflict exists. This will normally be at least 3NM from the departure end of the runway. The distance may be less for aircraft with high climb performance. The distance should be based on pilots being aware of traffic and the ability of the aircraft to climb above and clear of the circuit area.

*Note: Pilots of departing aircraft should be aware of traffic intending to join the circuit by the recommended overfly procedure, as they can be 2,000FT or higher above aerodrome elevation.*

9.6.2 An aircraft captain of an IFR flight must establish flight on the departure track as soon as practicable after take-off and within 5NM of the aerodrome, except that, at aerodromes which have published standard instrument departure procedures, an IFR flight may depart in accordance with those procedures. When established on the departure track, and clear of the circuit traffic, the aircraft captain must report departure to ATC unless instructed otherwise.

9.6.3 This report must include the following information:

Non-surveillance	Surveillance
Departure time	Current position
Outbound track in degrees magnetic	Present level
Intended cruising level	Intended cruising level
Estimate for the first en route reporting point	Estimate for the first en route reporting point

9.6.3.1 The departure time must be reported as follows:

- a. current time minus an adjustment for the distance from the aerodrome; or
- b. when over or abeam the aerodrome.

9.6.4 If the pilot transmits the departure report before intercepting the departure track the report must include advice that the aircraft is manoeuvring to intercept departure track.

9.6.5 When circumstances dictate that flight notification details be submitted in-flight, the above items must be combined with the appropriate items of the flight notification, and prefixed with the words "FLIGHT PLAN".

**9.7 Climb and Cruise Procedures**

9.7.1 The aircraft captain of an IFR flight must notify the intention to amend route, deviate from track or change level in sufficient time for ATS to advise traffic. When a position estimate changes by more than 2MIN, the pilot must advise ATS.

9.7.2 Pilots must give ATS notice of an impending position report by use of the word "POSITION"; e.g., "MELBOURNE CENTRE (call-sign) POSITION". Pilots must wait for the ATS instruction before reporting position.

9.7.3 Pilots must report maintaining an assigned level.

9.7.4 After any en route frequency change, an aircraft captain of an IFR flight must advise present level. If the aircraft is not at its planned cruising level, the pilot must also provide advice of the level to which the aircraft is being climbed.

9.7.5 When operating in Class G airspace in proximity to a controlled aerodrome, pilots should consider monitoring the TWR frequency to enhance situational awareness of traffic entering and leaving the CTR.

9.7.6 A pilot of a flight intending to operate in the vicinity of a non-controlled aerodrome at altitudes used by arriving and departing aircraft should:

- a. monitor the appropriate VHF, and broadcast by 10NM or earlier from the aerodrome commensurate with aircraft performance and pilot workload with an ETA (unless otherwise specified in ERSA); and
- b. where possible, avoid the circuit area and arrival and departure tracks.

### 9.8 Position Reports

9.8.1 Except when identified, position reporting is mandatory when operating under the IFR and must normally be made at the positions or times notified on the flight notification (See FIHA ENR 1.10 [para 3.5.2](#) for flight notification requirements).

9.8.2 The position report format is identified at [APPENDIX 1](#).

9.8.3 When an aircraft is holding due weather, ATS will nominate scheduled reporting times which will normally be at 15MIN intervals.

9.8.4 IFR aircraft operating area-type flights and nominating scheduled reporting times may limit the report to level and the present position or the sector of the survey area in which the aircraft is currently operating.

### 9.9 Descent from Controlled Airspace

9.9.1 Before descending from controlled airspace into Class G airspace and before separation with any aircraft operating near the base of controlled airspace can be compromised, the aircraft captain of an IFR flight must report position, level, intentions and estimate for next position/destination to the ATS unit providing services in Class G airspace. If the report is made using HF radio, a broadcast must be made on the appropriate area VHF frequency.

### 9.10 Arrival Information

9.10.1 A pilot of an IFR flight must report when changing to the CTAF when ATS frequency will not, or cannot, be monitored. This report must include the aerodrome location and frequency.

9.10.2 Pilots of IFR flights conducting local training, an instrument approach, or a holding pattern, may extend their SARWATCH by an "OPERATIONS NORMAL" call at scheduled times.

### 9.11 Landing Manoeuvres

9.11.1 Prior to entering the circuit at a non-controlled aerodrome, aircraft should avoid the flow of traffic until established in the circuit. The 'standard aerodrome traffic circuit' facilitates the orderly flow of traffic and is normally a left circuit pattern with all turns to the left, unless published in the AIP. Landings should be accomplished on the operational runway most closely aligned into wind. Wind and landing direction indicators can be checked while at an altitude of +500FT above the circuit height.

*Note: If jet, turbo prop or high performance piston aircraft operate at the aerodrome, 2000FT AGL is a safer height to remain clear of all circuit traffic.*

9.11.2 An aircraft approaching a non-controlled aerodrome for a landing should join the circuit in accordance with [sub-section 9.12](#) unless it is:

- a. following an instrument approach procedure in IMC; or
- b. conducting a visual circling procedure after completion of an instrument approach procedure; or
- c. conducting a straight-in approach in accordance with [sub-section 9.13](#).

9.11.3 The runway to be used for landing should be:

- a. the most closely aligned into-wind runway; or
- b. when operational reasons justify, any other available landing direction provided the nominated circuit is executed without conflict to landing or take-off traffic using the most into-wind runway; and
- c. serviceable, and cleared of ground maintenance equipment and personnel.



- 9.11.4 Aircraft approaching a non-controlled aerodrome for landing must make all turns to the left except:
- a. where right hand circuits are specified for the aerodrome; or
  - b. when entering the upwind, crosswind or downwind leg; or
  - c. when following an instrument approach procedure in IMC; or
  - d. when conducting a visual circling procedure after completion of an instrument approach procedure.

**9.12 Circuit Entry**

9.12.1 Where a pilot is unfamiliar with the aerodrome layout, or when its serviceability, wind direction, wind speed, or circuit direction cannot be ascertained prior to arrival, the overfly procedure should be used. The pilot should overfly or circle the aircraft at least 500FT above the circuit altitude, usually 2,000FT or more above the aerodrome elevation. When the circuit direction has been determined, the pilot should position the aircraft to a point well clear (normally the non-active side of the circuit) before descending to the circuit altitude that equates to the aircraft's performance. Pilots should not descend into the traffic circuit from directly above the aerodrome. Refer AC 91.10.

9.12.2 For low performance ultralight aircraft and rotorcraft with a maximum speed of approximately 55 KT, it is recommended that the aircraft overfly midfield at 500FT above aerodrome elevation. This will minimise the risk of conflict with higher or faster traffic.

*Note: Ultralight aircraft pilots who choose to use the overfly join procedure above the circuit altitude should be aware:*

- a. *faster larger aircraft may not be able to see you easily;*
- b. *faster larger aircraft can create significant wake turbulence;*
- c. *faster larger aircraft will not be able to slow to the speeds of an ultralight aircraft and follow; and*
- d. *faster larger aircraft - prior to arriving in the circuit and when below 10,000FT - can be at speeds up to 250KT. Therefore, although aircraft should be at 200KT maximum in the circuit, an aircraft reporting at 20NM from the aerodrome could be in the vicinity of the circuit within 5 minutes.*

9.12.3 For aircraft arriving and intending to join the circuit from overhead, the aircraft should descend on the non-active side of the circuit and be established at its circuit altitude as it crosses the runway centreline on crosswind, at between midfield and the departure end of the runway.

9.12.4 When arriving on the live side, the recommended method is to arrive at the circuit altitude entering midfield at approximately 45 degrees to the downwind leg while giving way to the aircraft already established in the circuit.

9.12.5 On downwind the applicable circuit altitude should be maintained until commencement of the base leg turn. The base leg position is normally when the aircraft is approximately 45 degrees from the reciprocal of the final approach path, measured from the runway threshold. Along the base leg continue to lookout and maintain traffic separation.

9.12.6 When on the final leg, confirm the runway is clear for landing. The turn onto final approach should be completed by a distance and height that is common to the operations at the particular aerodrome and commensurate with the speed flown in the circuit for the aircraft type. In any case, the turn onto final should be completed by not less than 500FT above aerodrome elevation. This should allow sufficient time for pilots to ensure the runway is clear for landing. It will also allow for the majority of aircraft to be stabilised for the approach and landing.

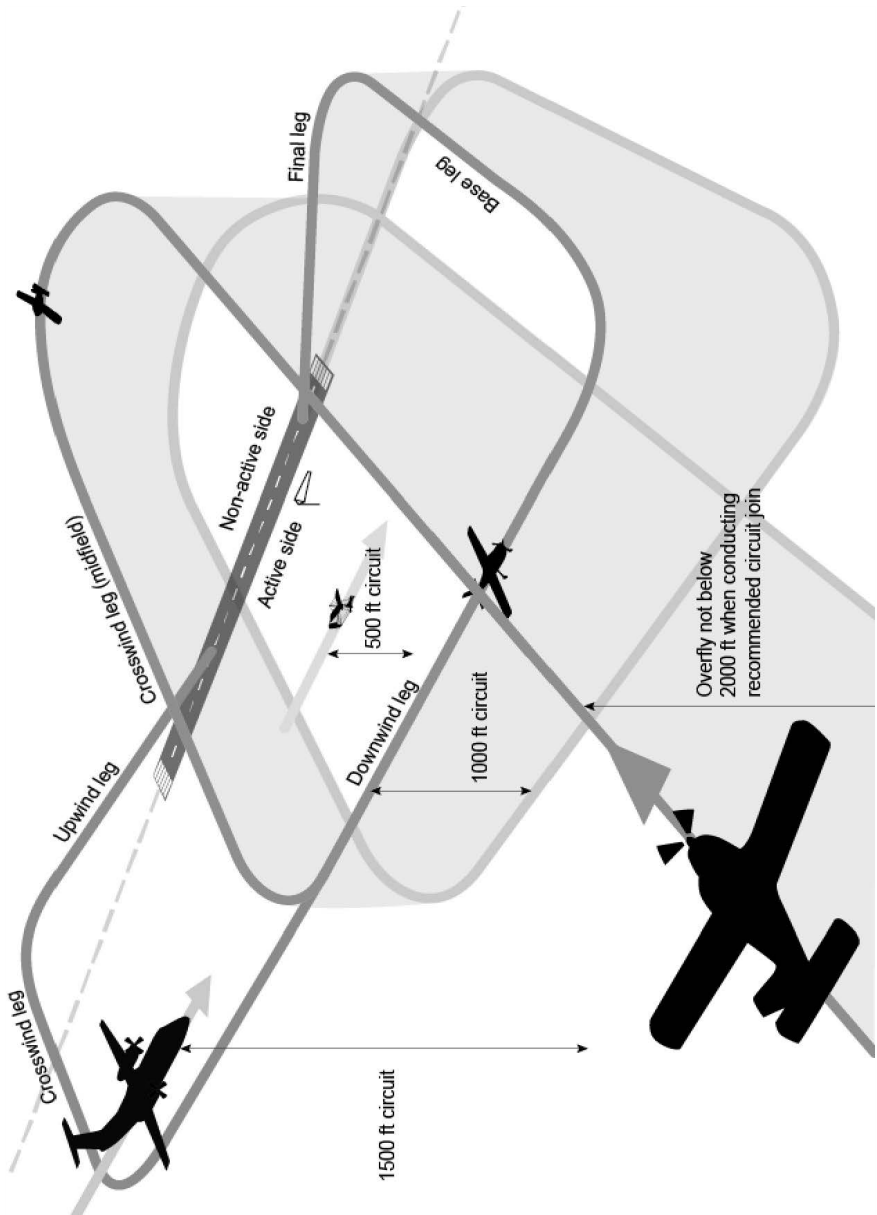

### 9.13 Straight-in Approach

9.13.1 ADF - Straight-in approaches are not a recommended standard procedure. Pilots who choose to adopt a straight-in approach should only do so when it does not disrupt or conflict with the flow of circuit traffic.

The pilot conducting a straight-in approach must give way to any other aircraft established and flying in the circuit pattern at the aerodrome.

9.13.2 ADF - The pilot must, before conducting a straight-in approach, determine the wind direction and speed and the runway in use at the aerodrome.

9.13.3 There are several ways to determine the wind direction, speed and runway in use:

- a. AWS, AWIS, AAIS, CA/GRS or UNICOM,
- b. Radio contact with a ground-based radio communication service, company agent, or aircraft operating at the aerodrome; or
- c. Visual indications - if the information cannot be determined by the above means.

9.13.4 ADF - When conducting a straight-in approach, the aircraft must be established on final at not less than 3NM from the landing runway's threshold CASR 91.395 (2)(c).

9.13.5 Pilots of aircraft conducting a straight-in approach at a non-controlled aerodrome should observe the following procedures:

- a. The aircraft captain should not commence a straight-in approach to a runway when the reciprocal runway direction is being used by aircraft already established in the circuit.
- b. All manoeuvring to establish the aircraft on final approach must be conducted outside a 3NM radius from the intended landing runway threshold.

*Note: Within 3NM, pilots are expected to make only minor corrections to line up accurately on final approach. This will enable pilots conforming to the aerodrome traffic pattern to optimise their visual scan for traffic along the final approach path.*

- c. The aircraft's transponder should be squawking and its external lights, where fitted, should be illuminated when on final approach. They should remain on until the aircraft has landed and is clear of all runways.
- d. An aircraft established on base leg or final approach for any runway has priority over an aircraft carrying out a straight-in approach.

### 9.14 Joining on Base

9.14.1 Joining on base leg, whilst not prohibited, is not a recommended standard procedure. At civil aerodromes CASA recommends pilots join the circuit on either the crosswind or downwind leg. However, pilots who choose to join on base leg should only do so if they:

- a. have determined the wind direction and speed;
- b. have determined the runway in use;
- c. give way to other circuit traffic and ensure the aircraft can safely (no traffic conflict likely) join the base leg applicable to the circuit direction in use at the standard height; and
- d. broadcast their intentions.

### Aerodrome traffic circuit

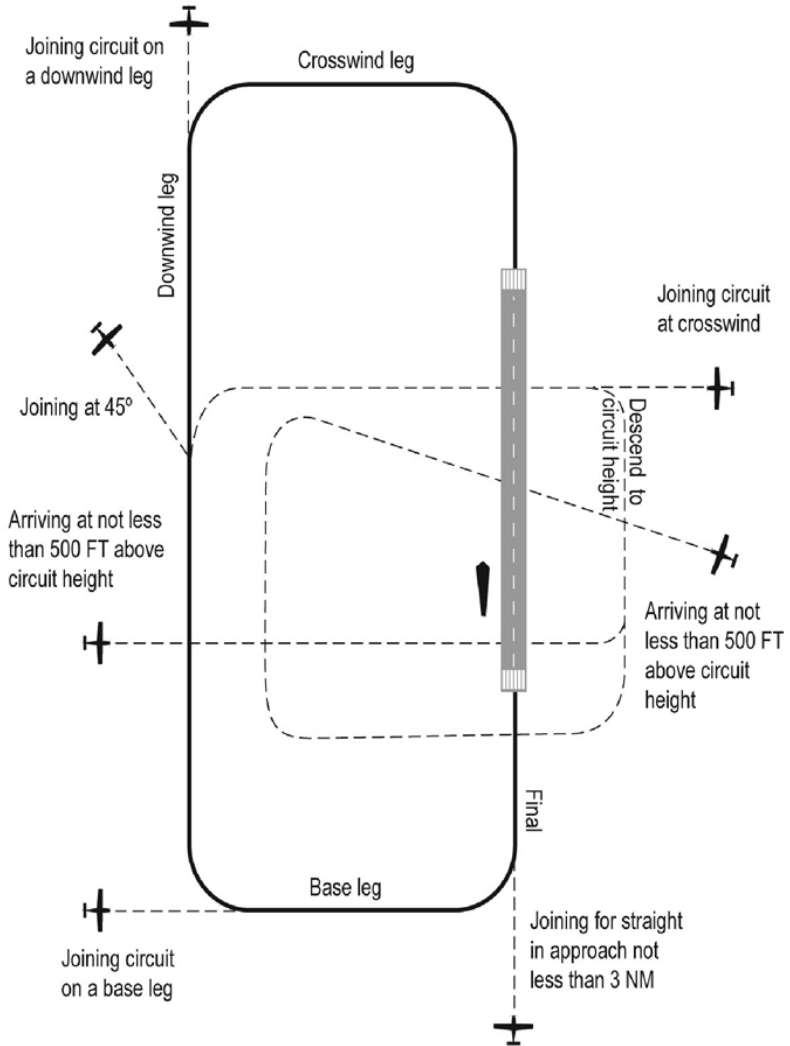

ENR 1.1

**9.15 Military Initial and Pitch Circuit Procedures**

9.15.1 For Military fast jet and training aircraft the preferred method of joining the circuit is via a procedure known as Initial and Pitch. The aircraft (or formation) will track to the Initial Point, a point at 5NM downwind of the runway in use displaced to the dead side, and track inbound at high speeds (see diagram below – not to scale).

9.15.2 Traffic permitting, Initial and Pitch procedures may be conducted at military, joint user, controlled and non-controlled aerodromes. At controlled aerodromes military pilots must comply with ATC circuit entry instructions unless approved for an Initial and Pitch entry.

9.15.3 When conducting this procedure, the height for fast jets is normally 1,500FT AGL and 1,000FT AGL for other aircraft. Aircraft on tactical missions can conduct the initial and pitch at below normal altitudes; this is referred to as a low Initial and Pitch.

9.15.4 At any stage once abeam the threshold of the runway in use, and safe to do so, the aircraft turns (“Pitches”) to join downwind and configures for landing.

9.15.5 Generally pilots conducting this manoeuvre will broadcast their position at the Initial Point and on the base turn.

**Military Initial and Pitch**

**Military Initial and Pitch**

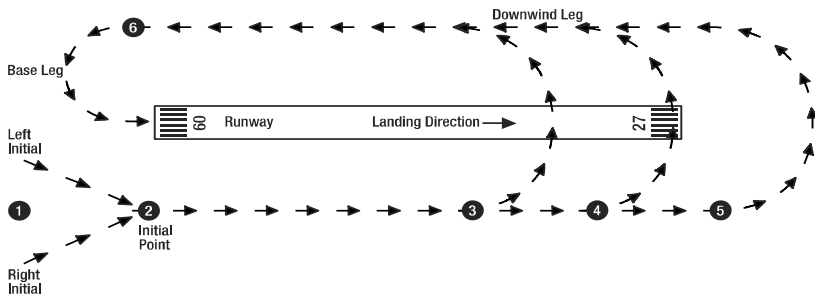

1. First call on run-in to Initial Point	4. Second aircraft in formation pitches out and positions Downwind behind first aircraft
2. Commence Initial	5. Subsequent aircraft in formation pitch out and positions Downwind behind second aircraft
3. First aircraft in formation pitches out and positions Downwind	6. First aircraft calls turning on Base leg for the entire formation. Clearances or instructions apply to entire formation. Subsequent aircraft in formation will make independent base calls
<i>Note: Aircraft conducting a low pitch will be at the low pitch altitude by position 3.</i>	

### 9.16 Separation Minima for Landing

9.16.1 An aircraft must not continue its approach to land beyond the threshold of the runway until:

- a. a preceding departing aircraft using the same runway is airborne and:
  - 1) has commenced a turn; or
  - 2) is beyond the point on the runway at which the landing aircraft could be expected to complete its landing roll and there is sufficient distance to manoeuvre safely in the event of a missed approach.
- b. a preceding landing aircraft using the same runway has vacated it and is taxiing away from the runway;
- c. a preceding aircraft using another runway, has crossed or stopped short of the landing aircraft's runway.

9.16.2 At aerodromes where gliders operate to a common circuit pattern from a parallel strip outside the runway strip, the above separation minima shall apply to aircraft landing or taking off on both runways as if they were a single runway, but aircraft taxiing or stationary on one runway must not affect operations on the other. Where gliders and glider tugs operate to a contra-circuit, simultaneous operations are permitted.

*Note: ADF - Pilots are reminded of their obligations to see and avoid other aircraft.*

### 9.17 The Traffic Mix and Other Hazards at Non-Controlled Aerodromes

9.17.1 At non-controlled aerodromes, there may be scheduled or non-scheduled air transport flight, gliders, parachutists, helicopters, gyroplanes, ultralights, balloons, general aviation aircraft, and agricultural aircraft operations.

9.17.2 Pilots should consult AC 91-10: 'Operations in the vicinity of non-controlled aerodromes', (in conjunction with the AIP) for detailed operating procedures when operating in the vicinity of non-controlled aerodromes.

9.17.3 In addition pilots should consult AC 91-14: 'Pilots' responsibility for collision avoidance in the vicinity of non-controlled aerodromes using see and avoid'.

9.17.4 The AC mentioned above provide guidance on a code of conduct (good airmanship) which, when followed will provide improved situational awareness and safety for all pilots when flying at, or in the vicinity of, non-controlled aerodromes.

## 10. OPERATIONAL REQUIREMENTS - GENERAL

### 10.1 Taxiing After Landing

10.1.1 After landing, the runway strip should be vacated as soon as practicable. Aircraft should not stop until clear of the runway strip.

### 10.2 SARWATCH

#### 10.2.1 Cancellation of SARWATCH Other Than SARTIME

10.2.1.1 Pilots wishing to cancel SARWATCH may do so by reporting to ATS.

10.2.1.2 SARWATCH is automatically cancelled without the need to report to ATS when landing:

- a. at a controlled aerodrome during tower hours; or
- b. at an uncontrolled aerodrome during AFIS hours.

10.2.1.3 When cancelling SARWATCH, pilots must include:

- a. the aircraft radio callsign;
- b. place of arrival or point from which SARWATCH services are no longer required;
- c. the words "CANCEL SARWATCH"; and
- d. when communicating with a unit other than that nominated, the name of the ATS unit to which the report shall be relayed.

10.2.1.4 SARWATCH may be cancelled in combination with a pilot report of changing to the CTAF, or in the circuit area, or after landing.

10.2.1.5 When the pilot of an IFR flight elects not to report in the circuit area to cancel SARWATCH and has not reported within 10 minutes of ETA, ATS will commence communications checks to obtain a landing report or an extension of SARWATCH.

10.2.1.6 ATS will acknowledge "CANCEL SARWATCH" reports with a readback of the place of arrival, if appropriate, and the words "SARWATCH TERMINATED".

**10.2.2 Cancellation of SARTIME**

10.2.2.1 When operating on a SARTIME, the pilot must cancel SARTIME by the time nominated and, during the contact with ATS, include the words "CANCEL SARTIME".

10.2.2.2 ATS will acknowledge "CANCEL SARTIME" reports with a readback of the place of arrival, if appropriate, and the words "SARTIME CANCELLED".

10.2.2.3 The preferred method to cancel a SARTIME is via telephone to CENSAR on 1800 814 931. When telephone facilities are not available you may use ATS frequencies.

10.2.2.4 For SARTIME flights, pilots of single VHF radio-equipped aircraft must cancel SARTIME before changing to the CTAF, or after landing.

**10.2.3 SARTIME for Departure**

10.2.3.1 When submitting flight notification, a pilot may nominate a SARTIME for departure for the initial departure aerodrome only. For intermediate departure, it may be nominated by telephone after landing, or as part of the arrival report associated with that aerodrome. Only one SARTIME may be current at any time.

10.2.3.2 The nomination of a SARTIME for departure does not absolve the pilot from complying with the requirements for the carriage of serviceable radio equipment, nor from making the prescribed reports.

10.2.3.3 An IFR departure report is not sufficient to cancel a SARTIME for Departure. Pilots who have nominated a SARTIME for Departure must use the phrase 'CANCEL SARTIME' with the departure report.

**10.3 Radio Telephony Requirements Outside Controlled Airspace**

10.3.1 The call-sign of the station or service being called must be included at the beginning of each exchange on VHF and HF.

*Note: The requirement of paragraph 9.1.10 applies when reporting on HF.*

10.3.2 All transmissions between aircraft or when broadcasting intentions must be prefixed with the aircraft call-sign.

10.3.3 When requesting operational information on FIS frequencies, the pilot must use the service callsign "FLIGHTWATCH" and, when on HF, include the frequency on which they are calling.

10.3.4 Use of the collective "ALL STATIONS" must precede a general information broadcast.

**10.4 Diversion to an Alternate Aerodrome**

10.4.1 The aircraft captain is responsible for taking appropriate diversion action based on information received. The pilot must provide the latest diversion time from the destination or from a point en route and, if required, the time interval.

### 10.5 Operating Requirements for Transponders

10.5.1 Pilots of aircraft fitted with a serviceable Mode 3A or Mode S transponder must activate the transponder at all times during flight, and if the Mode 3A transponder is Mode C capable, that mode must also be operated continuously.

10.5.2 Aircraft equipped with a Mode S transponder having an aircraft identification feature shall transmit the aircraft identification as specified in Item 7 of the flight notification or, when no flight notification has been filed, the aircraft registration.

10.5.3 For further information on the operation of transponders, including normal and emergency codes, see FIHA ENR 1.6 [Section 7](#).

### 10.6 Operating Requirements for ADS-B Transmitters

10.6.1 Pilots of aircraft fitted with a serviceable ADS-B transmitter which has been confirmed suitable to receive ADS-B derived ATS surveillance services in Australia should activate the transmitter at all times during flight.

*Note 1: Some ADS-B installations may share controls with the SSR transponder, meaning that independent operation of the two systems is not possible.*

*Note 2: If it is not possible to comply with a particular instruction the pilot must advise ATC and request alternative instructions.*

10.6.2 Aircraft equipped with ADS-B having an aircraft identification feature shall transmit the aircraft identification as specified in the flight notification or, when no flight notification has been filed, the aircraft registration.

10.6.3 For further information on the operation of ADS-B transmitters, including normal and emergency codes, see ENR 1.6 sub-section 6.5.

## 10.7 Alternate Aerodromes

### 10.7.1 General

10.7.1.1 ADF - Unless otherwise approved by the MAO, the aircraft captain must make provision for flight to an alternate aerodrome, when required, in accordance with the paragraphs of this section (i.e. all of section 10.7).

10.7.1.2 When a flight is required to provide for an alternate aerodrome, any aerodrome may be so nominated for that flight provided:

- a. it is suitable as a destination for that flight; and
- b. is not an aerodrome for which that flight would require to provide for an alternate aerodrome; and
- c. is not a helideck.

10.7.1.3 When an aerodrome forecast is not available, the aircraft captain must make provision for a suitable alternate that has an available forecast.

10.7.1.4 **ADF** - The requirement to plan for an alternate is to be made after considering the following conditions:

- a. Weather conditions.
- b. Radio navigation aids and GPS equipment (for approved operators).
- c. Nominated flight rules.
- d. Runway lighting.

10.7.1.5 **ADF/ARMY** - If the aircraft captain is the holder of a Q/R Instrument Rating (RIR for Army), any restrictions placed on it are in addition to the requirements specified in this document.

10.7.1.6 **RAN** - Alternate requirements are not applicable to RAN helicopters operating with air capable units. However, due cognisance must be given to the aircraft/ship approach aids and availability of additional air capable platforms, prior to operations in adverse weather conditions. ELVA minima are not to be used when determining minimum acceptable conditions for NORMAL operations.



10.7.1.7 **ARMY/RAN** - Alternate requirements are not applicable to Army and Navy rotary aircraft operating by day under the VFR. Army/RAN SIs detail alternate requirements for NVD operations.

**10.7.2 Weather Conditions**

10.7.2.1 Except when operating an aircraft under the VFR by day within 50NM of the point of departure, the aircraft captain must provide for a suitable alternate aerodrome when arrival at the destination will be during the currency of, or up to 30MIN prior to the forecast commencement of, the following weather conditions:

- a. cloud - more than SCT below the alternate minimum (see [paras 10.7.2.10](#) and [10.7.2.11](#)); or  
*Note: In determining requirements for alternate aerodromes, forecast amounts of cloud below the alternate minima are cumulative. For determining requirements, the cumulative cloud amount is interpreted as follows:*
  - 1) FEW plus FEW is equivalent to SCT,
  - 2) FEW plus SCT is equivalent to BKN,
  - 3) SCT plus SCT is equivalent to BKN or OVC.
- b. visibility - less than the alternate minimum; or
- c. visibility - greater than the alternate minimum, but the forecast is endorsed with at least a 30% probability of fog, mist, dust or any other phenomenon restricting visibility below the alternate minimum; or
- d. a thunderstorm or associated severe turbulence, or a forecast of at least a 30% probability of such an event; or
- e. wind - a crosswind or tailwind component more than the maximum for the aircraft.

*Note 1: Wind gusts must be considered.*

*Note 2: ARMY - Paragraph e. (above) is not applicable to helicopter operations.*

10.7.2.2 When operating a helicopter under the VFR, and the use of helicopter VMC is permissible at the destination, the aircraft captain must provide for a suitable alternate aerodrome when either of the following conditions is forecast at the destination:

- a. cloud - more than SCT below a ceiling of 1,000FT; or
- b. visibility - less than 3,000M.

*Note: ARMY - Alternate requirements are not applicable to Army aircraft operating by day under the VFR.*

10.7.2.3 When weather conditions at the destination are forecast to be as specified at [paragraph 10.7.2.1](#), but are expected to improve at a specific time, provision for an alternate aerodrome need not be made if sufficient fuel is carried to allow the aircraft to hold until that specified time plus 30MIN.

10.7.2.4 When weather conditions at the destination are forecast to be above the values specified at [paragraph 10.7.2.1](#) but, additionally, intermittent or temporary deteriorations in the weather below the values are forecast, provision of an alternate need not be made if sufficient fuel is carried to allow the aircraft to hold for:

- a. 30MIN for intermittent deterioration (INTER); and
- b. 60MIN for temporary deterioration (TEMPO).

*Note: ADF - When flights are conducted in the local training area with two-way radio communication between aircraft and a control agency at home base, the holding fuel and alternate requirements imposed under "TEMPO" and "INTER" conditions may be waived at the authorising officer's discretion, if VFR or Special VFR applies in the circuit.*

10.7.2.5 When thunderstorms or their associated severe turbulence or their probability is forecast at the destination, sufficient fuel must be carried to permit the aircraft to proceed to a suitable alternate or to hold for:

- a. 30MIN when the forecast is endorsed INTER; or
- b. 60MIN when the forecast is endorsed TEMPO.

10.7.2.6 When a forecast has multiple INTER or TEMPO deteriorations and holding fuel will be carried, fuel must be carried to hold for only the most limiting requirement. INTER and TEMPO holding fuel requirements are not cumulative.

10.7.2.7 When TAFs include a FM or a BECMG, causing an operational requirement to either become effective or be removed, the timing for the change in operational requirement is as follows:

- a. When the weather following the FM or BECMG is forecast to create an operational requirement, that operational requirement will become effective 30MIN before the start of the FM time, or 30MIN before the start of the BECMG period.
- b. When the weather following the FM or BECMG is forecast to remove an operational requirement, that operational requirement will remain effective until 30MIN after the FM time or 30MIN after the end of the BECMG period.

10.7.2.8 The fuel required by [paragraph 10.7.2.4](#) or [10.7.2.5](#) must be carried when the ETA of the aircraft at its destination or alternate falls within the period 30MIN before the forecast commencement time to 30 MIN after the expected time of cessation of these deteriorations. If the holding time required by [paragraph 10.7.2.4](#) or [10.7.2.5](#) extends past 30MIN after the forecast cessation of these deteriorations, the aircraft need only carry sufficient fuel to hold until 30MIN after the forecast cessation time.

10.7.2.9 At aerodromes receiving a TAF3 service, and only during the first 3 hours of the TAF3 validity, not beyond the end time for the TAF3 service if such a time is specified, the following do not apply:

- a. 30 minute buffers required by [paragraph 10.7.2.7](#) and [10.7.2.8](#),
- b. the alternate or holding fuel required by:
  - 1) [paragraph 10.7.2.1](#) (c) for reduction in visibility, or
  - 2) [paragraph 10.7.2.5](#) for any PROB30 or PROB40 for TS or associated severe turbulence.

*ADF Note: As Probability Forecasts are only to be used if the estimated probability of occurrence is thirty or forty per cent, and shall only be used with reference to thunderstorms or poor visibility (less than the alternate minimum) resulting from fog, mist, dust, smoke or sand; all associated weather listed in a PROB30 or PROB40 forecast is directly related to either TS, or a reduction in visibility. As such, all associated weather in that PROB30 or PROB40 forecasts do not apply IAW paragraph 10.7.2.9.b.*

10.7.2.10 **ADF** - For IFR flights, the alternate minima are as follows:

- a. Cloud - more than SCT below HAA or HAT (as published) plus 500FT, for the approach procedure where only one aid is required or in the case where two aids are required, more than SCT below the HAA or HAT (as published) plus 500FT for the approach procedure with the second lowest MDA/DH that is available to the aircraft type.
- b. Visibility - less than the distance for the approach procedure obtained by adding 2,000M to the visibility value (as published) where only one aid is required or where two aids are required, by adding 2,000M to the second lowest visibility that is available to the aircraft type.
- c. By day only - for aerodromes without an instrument approach procedure, or that has an instrument approach procedure but the pilot is unable to conduct that procedure, the alternate minima is the lowest safe altitude for the final route segment plus 500FT and a visibility of 8KM.

*Note: Alternate minima based on weather for night IFR operations is only paragraphs (a) and (b) above. If the planned destination aerodrome for an IFR flight by night does not have any IAP, or any IAP that the pilot can conduct, then due to paragraph 10.7.3.1, the flight must plan for a destination alternate aerodrome. By virtue of paragraph 10.7.1.2, the destination alternate aerodrome must have an IAP that the pilot is able to conduct, which would then result in paragraphs (a) and (b) being the applicable alternate weather minima.*

10.7.2.11 For flight by aeroplanes under the VFR (day or night) and helicopters operating under the VFR at night, the alternate minima are a ceiling of 1,500FT and a visibility of 8KM.

10.7.2.12 **ADF** - For VFR helicopter operations by day, the alternate minima are the same as for night unless the additional conditions specified in for VMC are met. When these additional conditions are met, the alternate minima requirements are as shown in [paragraph 10.7.2.2](#).

*Note: For VMC helicopter operations in non-controlled airspace (Class G), the same day operation conditions apply to ADF when using NVD/NVG equipment at night.*

### 10.7.3 Radio Navigation Aids

10.7.3.1 **ADF** - A flight which is planned to be conducted under the IFR on the last route segment to its destination must provide for a suitable alternate aerodrome, unless:

- a. the destination is served by a radio navigation aid for which an instrument approach procedure has been prescribed and the aircraft is fitted with two independent and separate radio navigation systems, each of which is capable of using the aid; or
- b. the destination is served by two radio navigation aids for which independent and separate instrument approach procedures have been prescribed and the aircraft is fitted with independent and separate radio navigation systems capable of using these aids.

*Note 1: A formation of aircraft may consider their aircraft equipment in total when determining the need for an alternate.*

*Note 2: GNSS equipment may be used as a suitable navigation aid to satisfy radio navigation aid alternate requirements. (refer ENR 3).*

10.7.3.2 A flight operating under the VFR at night (see FIHA ENR 1.2, [Section 1.1](#)) must provide an alternate aerodrome within one (1) hour flight time of the destination unless:

- a. the destination is served by a ground based radio navigation aid (NDB/VOR/TAC) and the aircraft is fitted with the appropriate radio navigation system capable of using the aid, and the pilot is competent in using the aid, or
- b. **ADF** - the aircraft is fitted with a GNSS receiver appropriate for an aircraft operated at night under the VFR, and the pilot is appropriately qualified.

*Note: NAVY - For Navy NVD/NVG VFR operations, an alternate is not required with respect to radio navigation aids if the aircraft is fitted with a suitable navigation system with less than 1nm position error.*

*Note: ARMY - For Army Night VFR unaided operations, an alternate is not required with respect to radio navigation aids if two-way radio communications can be established with a ground station to which the aircraft is capable of homing.*

10.7.3.3 If aircraft navigation is to be conducted using a GNSS receiver certified only to (E)TSO C-29, navigation to a destination alternate aerodrome must be planned using a navigation system other than GNSS.

### 10.7.4 Runway Lighting

10.7.4.1 **Portable lighting.** When a flight is planned to land at night at an aerodrome where the runway lighting is portable, provision must be made for flight to an alternate aerodrome unless arrangements are made for a responsible person to be in attendance during the period specified in *paragraph 10.8.1.c*, to ensure that the runway lights are available during that period.

*Note: ARMY - For night unaided operations an alternate is not required with respect to lighting at the destination if a tactical landing aid is available at the destination. Unless operating units' SIs dictate otherwise, the minimum acceptable light source shall be a "T aid".*

*For NVD operations see paragraph 10.7.4.8.*

10.7.4.2 **Standby power.** When a flight is planned to land at night at an aerodrome with electric runway lighting, whether pilot activated or otherwise, but without standby power, provision must be made for flight to an alternate aerodrome unless portable runway lights are available and arrangements have been made for a responsible person to be in attendance during the period specified in *paragraph 10.8.1.c*, to display the portable lights in the event of a failure of the primary lighting.

10.7.4.3 **PAL.** When a flight is planned to land at night at an aerodrome with PAL and standby power, provision must be made for a flight to an alternate aerodrome equipped with runway lighting unless a responsible person is in attendance to manually switch on the aerodrome lighting.

10.7.4.4 **ADF - Alternate aerodromes - PAL.** An aerodrome served by PAL may be nominated as an alternate aerodrome. There is no requirement for a responsible person on the ground to be in attendance, but the aircraft must be equipped with:

- a. dual VHF; or
- b. single VHF and HF communications and carries 30MIN holding fuel to allow for the alerting of ground staff in the event of a failure of the aircraft's VHF communication.

Where an aircraft is fitted with single VHF and no HF communications, the alternate aerodrome must be one which is:

- a. served by a lighting system which is not pilot activated; or
- b. served by PAL and there is a responsible person in attendance to manually switch on the aerodrome lighting.

10.7.4.5 The alternate requirements of [paragraph 10.7.4.1](#) to [10.7.4.4](#) inclusive need not be applied if the aircraft carries holding fuel for first light plus 10MIN at the destination.

10.7.4.6 An alternate aerodrome nominated in accordance with the requirements in [paragraph 10.7.4.2](#) and [10.7.4.3](#) need not have standby power or standby portable runway lighting.

10.7.4.7 A responsible person under [paragraph 10.7.4.2](#) is one who has been instructed in, and is competent to display, the standard runway lighting with portable lights.

10.7.4.8 **ADF - Alternate aerodromes – NVD/NVG.** For NVD/NVG operations an alternate is not required with respect to lighting at the destination.

### 10.8 Suitability of Aerodromes

10.8.1 **ADF - General.** The following procedures are an acceptable means of compliance with the requirements that aircraft not be operated in manner that creates a hazard in relation to the suitability of an aerodrome:

- a. pilots should verify that the intended aerodrome meets the requirements of DASR ORO.05(a)6 as regards to its suitability for the intended operation. Additionally, pilots should confirm with the aerodrome operator that the pavement strength of the aerodrome meets the standards required by the aircraft being operated;
- b. pilots should ensure that runway edge lighting, threshold lighting, illuminated wind direction indicator, and any obstacle lighting (if required) is serviceable for any planned night operations. Additional lighting may be required for particular operations – refer to the applicable regulation;
- c. When aerodrome lighting is required and PAL is not being used, the aircraft captain or operator should ensure that arrangements have been made for the runway, obstacle and taxiway lighting to be operating during the following periods:
  - 1) departure: from at least 10 minutes before departure to at least 30 minutes after take-off;
  - 2) arrival: from at least 30 minutes before ETA to the time landing and taxiing has been completed.

*Note 1: An operator planning a flight by an aircraft with tyre pressures and/or weight in excess of that permitted by AD 1.1 Section 7. must ensure that a pavement concession is obtained.*

*Note 2: Emergency Landings. When safety is involved, the nearest aerodrome which will permit a landing without danger to the aircraft may be used, irrespective of the damage that may be caused to the pavement.*

*Note 3: Aerodrome lighting at an aerodrome where a control tower is operating will be activated by ATC as necessary. Pilots requiring aerodrome lighting outside the control tower's published hours should use PAL, if available, or make appropriate arrangements with ATC. If ATC has already ceased duty, requests should be directed to the local aerodrome operator. Confirmation should be obtained that requests for lighting will be satisfied.*

*Note 4: A pilot having made arrangements with ATS for night lighting must notify any change in requirements.*

*Note 5: Additional details on acceptable means of compliance referred to may be approved by the MAO.*

### 10.8.2 Runway Width

10.8.2.1 ADF - Specific runway width limitations may be specified by the MAO.

### 10.8.3 Aerodrome Lighting

10.8.3.1 **ARMY** - For Army aircraft operating at landing areas other than certified or registered aerodromes, the minimum requirements shall be specified in unit SI.

## 10.9 Fuel Requirements

### 10.9.1 General

10.9.1.1 **ADF** - Guidance regarding fuel to be carried is contained in FEG SI, or equivalent.

### 10.9.2 Minimum Fuel

10.9.2.1 The aircraft captain shall advise ATC of a minimum fuel state by declaring MINIMUM FUEL when, having committed to land at a specific aerodrome, the aircraft captain calculates that any change to the existing clearance to that aerodrome may result in landing with less than final reserve fuel.

*Note 1: The declaration of MINIMUM FUEL informs ATC that all planned aerodrome options have been reduced to a specific aerodrome of intended landing and any change to the existing clearance may result in landing with less than final reserve fuel. This is not an emergency situation but an indication that an emergency situation is possible should any additional delay occur.*

*Note 2: Pilots should not expect any form of priority handling as a result of a "MINIMUM FUEL" declaration. ATC will, however, advise the flight crew of any additional expected delays as well as coordinate when transferring control of the aircraft to ensure other ATC units are aware of the flight's fuel state.*

### 10.9.3 Emergency Fuel

10.9.3.1 The aircraft captain must declare a situation of emergency fuel by broadcasting MAYDAY MAYDAY MAYDAY FUEL, when the calculated usable fuel predicted to be available upon landing at the nearest aerodrome where a safe landing can be made is less than the final reserve fuel.

*Note 1: MAYDAY FUEL declaration is a distress message.*

*Note 2: In circumstances where a normal approach and landing is expected and the pilot assesses there is no requirement for emergency services, ATS should be so advised as early as possible e.g. "EXPECTING NORMAL APPROACH AND LANDING, EMERGENCY SERVICES NOT REQUIRED".*

## 10.10 Information by Pilots

10.10.1 An aircraft captain becoming aware of any irregularity of operation of any navigational or communications facility or service or other hazard to navigation must report the details as soon as practicable. Reports must be made to the appropriate ATS unit, except that defects, or hazards on a landing area must be reported to the person or authority granting use of the area.

10.10.2 Pilots are requested to advise ATS about any deterioration or improvement of reported runway surface conditions, deceleration and/or directional control. See *APPENDIX 1 (AIREP)* and *AD 1.2 Section 3* for details about Runway Condition Reports (RCR) and reporting deceleration and directional control.

10.10.3 During the bush fire period, aircraft captains should notify the nearest ATS unit promptly of any evidence of bush fires observed which they believe have not been reported previously.

10.10.4 Australian Customs and Border Protection (Customs) is the government civil surveillance organisation which coordinates aerial patrols of border and off-shore areas to detect breaches of Customs, Fisheries, Quarantine and Immigration legislation.

10.10.5 Pilots are invited to assist Customs by reporting activities which appear to warrant recording or investigation. Reports should be made to the in-contact ATS unit. Observations warranting a report include:

- a. observed marine pollution (including oil slicks);
- b. shipping abnormalities;
- c. other unusual activities within approximately 300NM of the coastline;
- d. suspicious activities of unidentified itinerant aircraft, especially if there is a suggestion that they are travelling from or to an overseas destination;
- e. aircraft signalling the ground or dropping objects;
- f. aircraft operating at night without navigation lights;
- g. aircraft operating from non-aerodrome sites, or unexplained or unusual activity at aerodromes or remote strips;
- h. possible illegal fishing within the 200NM fishing zone;
- i. possible smuggling of drugs or other prohibited goods;
- j. possible illegal immigrants entering Australia;
- k. unauthorised landings by sea or air;
- l. threats to the well being of the Great Barrier Reef or other environmentally significant areas; and
- m. unusual activities in remote areas.

10.10.5.1 Such reports should be elaborated on at debriefing.

10.10.6 Observed volcanic activity must be included in AIREP.

10.10.7 All air crews are to report immediately by radio to the appropriate ATC facility, any incidents of unauthorised laser illumination. Reports should include event position, altitude, colour of laser beam(s), originating direction and position, and any other relevant information deemed necessary for ATC and law enforcement action.

10.10.8 Air crews flying in Class G airspace are also requested to immediately broadcast a general laser illumination caution on the appropriate CTAF. This general caution should include the following elements: Phrase "UNAUTHORISED LASER ILLUMINATION EVENT(s) HAS/HAVE BEEN REPORTED" (general positional information including location and altitude).

### **10.11 Flights Over Water**

10.11.1 This section from Airservices Australia AIP not applicable to ADF.

### **10.12 Procedures for Ground Operation of Turbo-Jet Aircraft**

10.12.1 Whenever an engine, other than the APU, of a turbo-jet aircraft is operating on the ground, the aircraft's anti-collision light(s) must be displayed, thereby indicating to pilots of other aircraft to exercise caution. Military turbo-jet aircraft should always be treated with caution as their anti-collision light may not be displayed even though an engine is running.

### **10.13 Clearances - Pilot Responsibility**

10.13.1 A clearance issued by an ATS unit is only an authorisation for the aircraft captain to proceed in accordance with the terms of the clearance. The clearance is not an authorisation for a pilot to deviate from any regulation, order, operating standard or procedure, or minimum altitude, nor to conduct unsafe operations in their aircraft. Further, the issuance and acceptance of a clearance in no way abrogates or transfers to an ATS unit the responsibilities of the aircraft captain.

## 10.14 Special Requirements

### 10.14.1 Special Standby of Fire Services

10.14.1.1 A pilot conducting training in take-offs and landings with a multi-engined aircraft may request the airport RFFS to stand by on the field. The request must be made through ATS or direct to the responsible Fire Officer.

### 10.14.2 Aeroplane and Rotorcraft Simulated Failures

10.14.2.1 This section from Airservices Australia AIP not applicable to ADF.

10.14.2.2 This section from Airservices Australia AIP not applicable to ADF.

### 10.14.3 Ab-initio Flying Training at an Aerodrome

10.14.3.1 This section from Airservices Australia AIP not applicable to ADF.

### 10.14.4 Fuel Dumping in Flight

10.14.4.1 **ADF** - Fuel dumping is prohibited in flight except in an emergency or when operationally necessary, or as directed by higher command.

10.14.4.2 When fuel dumping is required, the aircraft captain should request authority from ATC before commencing a fuel dump, and must:

- a. notify ATC immediately after an emergency fuel dump;
- b. take reasonable precautions to ensure the safety of persons or property in the air and on the ground; and
- c. where possible, conduct a controlled dump in clear air above 6000FT and in an area nominated by ATC.

10.14.4.3 The pilot must advise ATC if radio silence is required during the fuel dumping operation.

### 10.14.5 Areas Having Limitations on Access

10.14.5.1 Although not involving a potential hazard to aircraft, operations over certain areas have limitations placed on them for environmental reasons. Refer to ERSA GEN for details.

### 10.14.6 Aerial Photography and Survey Operations

10.14.6.1 Pilots and operators intending to conduct aerial photography or survey operations in controlled airspace should liaise with the ATC unit responsible for the area(s) concerned prior to submitting flight plans. ATC clearance limitations and restrictions on times, tracks and/or levels, which could inhibit the proposed operation(s), may apply in the desired airspace. Preflight approval will enable pilots to plan tasks accordingly, thus minimising disruption to programs.

### 10.14.7 Aerial Photography of Military Installations

10.14.7.1 Pilots or operators intending to photograph military installations or areas which include military installations must contact the appropriate military authority as such photography may require prior approval or not be permissible.

### 10.14.8 Police Operations

10.14.8.1 An aircraft operated by police authorities which requires priority in situations where life is threatened must use the call-sign "**POLAIR RED**" or "**FEDPOL RED**". Police must call "**POLAIR/FEDPOL RED PRIORITY**" on first contact.

### 10.14.9 ADF - Military Authority Assumes Responsibility for Separation of Aircraft (MARSA)

10.14.9.1 **Definition.** MARSA is a procedure which authorises pilots of military aircraft to assume responsibility for separation between their aircraft and other nominated military aircraft (or military contract civil aircraft) within Australian controlled airspace.

10.14.9.2 **Introduction.** Certain military operations require separation standards or procedures not generally available for routine civil and military flights; e.g., aerial refuelling, towed banner operations. MARSA is a procedure whereby military pilots undertake to self separate where it would normally be the responsibility of ATC. Pilots are responsible for identifying the circumstances necessitating the application of MARSA and for initiating a request to ATC to operate the procedure.

10.14.9.3 **Purpose.** The purpose of the procedure is to facilitate military operations and therefore should not be used as a means of minimising delays to flight.

10.14.9.4 Use of the procedure shall not be initiated by ATC, or invoked indiscriminately by pilots. When MARSA operations are anticipated to take place, notification to ATS should be included on the flight notification.

10.14.9.5 **Authority.** Military Commands are responsible for authorising MARSA operations of aircraft and determining the terms of use.

10.14.9.6 **Separation.** ATC shall provide standard separation between aircraft engaged in MARSA operations and all non-participating aircraft. Initiation of MARSA procedures may be delayed by ATC whenever a conflict with non-participating aircraft is evident. MARSA shall only be used between aircraft using the same level or manoeuvring within the same block of airspace.

The respective pilots shall commence self separation utilising MARSA procedures on receipt of approval from ATC to conduct the operation. The MARSA procedure shall continue to apply to participating aircraft until a level separating the MARSA units has been assigned and reached, unless it is known that all aircraft operating within MARSA are separated by an ATC standard that can be maintained.

When requested, RADAR assistance may be provided to participating MARSA aircraft to rendezvous with other participating aircraft. ATC should provide only advisory information to aircraft requesting this service as the ultimate responsibility for separation in the procedure remains with the pilots.

10.14.9.7 **MARSA clearance.** Pilots requesting MARSA should be fully conversant with the procedures and responsibilities. ATC shall ensure MARSA participants are aware of the operating limits when issuing clearances to commence and terminate. To achieve this, the phrase "MARSA (call-sign)" shall be included in the clearance for any aircraft to participate in MARSA, and during termination of the procedure.

- a. To commence MARSA operations (each aircraft):  
e.g. "MAINTAIN BLOCK FLIGHT LEVEL TWO SEVEN ZERO TO FLIGHT LEVEL TWO NINE ZERO, MARSA (call-sign)".
- b. The block level required extends beyond the limit of CTA/OCA, the clearance shall be issued to include only that portion within CTA/OCA: e.g. "NOT ABOVE FLIGHT LEVEL...".
- c. When MARSA operations are complete:  
e.g. "Aircraft 1, CLIMB TO FLIGHT LEVEL THREE THREE ZERO, MARSA (call-sign)",  
"Aircraft 2, CLIMB TO FLIGHT LEVEL THREE ONE ZERO, MARSA (call-sign)".
- d. At conclusion of MARSA operations and when standard separation is being applied between aircraft, each aircraft shall be advised: e.g. "MARSA TERMINATED".

#### 10.14.10 "Due Regard" Operations

10.14.10.1 Certain operations by State aircraft (usually military), referred to as "Due Regard" operations, cannot be conducted in compliance with normal air traffic rules and procedures. Where these operations are necessary, Article 3 of the Convention on International Civil Aviation (Chicago Convention) (1944) requires contracting States to "have due regard for the safety of navigation of civil aircraft". Safety mitigators may include operations in VMC and/or use of surface and airborne RADAR.



#### 10.14.11 Security Awareness

10.14.11.1 All members of the aviation industry, including general aviation, charter, crop duster, helicopter and local airport operators should be particularly vigilant with regard to any suspicious activity relating to the use, training in, or acquisition of dangerous chemicals, including threats, unusual purchases and/or unusual contacts with the public.

10.14.11.2 Any suspicious circumstances or unusual behaviour should be immediately reported to the police and the relevant aircraft, airline or airport operator.

#### 10.14.12 Fire Operations

An aircraft operated by fire authorities which requires priority should notify the flight as Fire or Flood Relief (FFR) and use the appropriate special task callsign as per GEN 3.4 para 5.21.

#### 10.14.13 Requirements for Community Service Flights (CSF)

This section from Airservices Australia AIP not applicable to ADF.

### 10.15 Helicopter Operations - At Aerodromes and in Helicopter Access Corridors and Lanes

#### 10.15.1 General

10.15.1.1 ADF - The procedures in this section apply to all helicopters operating in the vicinity of aerodromes and in helicopter access corridors and lanes.

#### 10.15.2 Taxiing

10.15.2.1 For all helicopters, maximum use of the "air transit" procedure should be made to expedite traffic movement and flow about an aerodrome.

10.15.2.2 All helicopters may use "air taxiing" procedures as required. However, wheeled helicopters, where practicable, are encouraged to "ground taxi" on prepared surfaces to minimise rotor wash and its effects.

10.15.2.3 At night a helicopter should not taxi via routes which do not meet the physical dimensions and lighting requirements specified in AC 139.R-01.

#### 10.15.3 Take-off/Departure

10.15.3.1 At locations within controlled airspace, helicopters may be granted a take-off clearance or instructed to report airborne, as appropriate, from any area nominated by ATC or the pilot, and assessed by the pilot as being suitable as a HLS.

10.15.3.2 Helicopters taking-off/departing must proceed in accordance with ATC instructions.

10.15.3.3 Subject to clearance, a turn after take-off may be commenced when the pilot considers that the helicopter is at a safe height to do so.

10.15.3.4 Unless requested by the pilot, a take-off clearance will not be issued for a helicopter if the tailwind component exceeds 5KT.

10.15.3.5 Prescribed exit "gates" and associated standard routes and/or altitudes may be provided to facilitate the flow of helicopter traffic. Procedures for their use will be promulgated in ERSA. Use of these "gates" is not mandatory. Helicopters may, subject to an ATC clearance, revert to the standard traffic procedures applicable to aeroplanes. This option may be more appropriate when operating larger helicopters.

10.15.3.6 At night a helicopter should not take-off from other than a site which conforms with the requirements specified in AC 139.R-01. Any illuminated runway or illuminated taxiway of dimensions commensurate with the size of the helicopter landing site applicable to the helicopter, in accordance with AC 139.R-01, is considered to meet the requirements of AC 139.R-01.

10.15.3.7 At a non-controlled aerodrome a pilot may take-off from any area which is assessed as being suitable as a HLS.

10.15.3.8 When the pilot elects to conduct the take-off from outside the flight strip of the runway in use by aeroplanes, the helicopter take-off path must be outside that flight strip.

10.15.3.9 Before take-off, the helicopter is to be positioned to the appropriate side of the runway in use so that the turn after take-off does not cross the extended centre line of that runway. The pretake-off positioning of the helicopter will be by air transit or by taxiing as appropriate.

10.15.3.10 The turn after take-off onto the desired departure track may be commenced when the pilot considers that the helicopter is at a safe height to do so. If the resultant departure track conflicts with the aeroplane traffic pattern, the helicopter should remain at 500FT above the surface until clear of that circuit pattern. Where this procedure is not practicable on environmental grounds, the helicopter is to adopt the standard departure procedure applicable to aeroplanes.

10.15.3.11 Pilots of radio equipped helicopters must broadcast intentions on the appropriate frequency before take-off.

#### 10.15.4 Helicopter Access Corridors and Lanes

10.15.4.1 The following procedures for operations within promulgated helicopter access corridors and lanes apply:

- a. maximum IAS of 120KT;
- b. helicopters must operate under VFR, usually not below 500FT above the surface by day, subject to flight over populous area restrictions and the limitations published in ERSA for authorised corridors by night;
- c. "see and avoid" procedures must be used;
- d. formation flights are restricted to line astern with the lead aircraft responsible for maintaining separation from other traffic in accordance with subparagraph c.;
- e. a traffic advisory service is available in access corridors;
- f. an ATS Surveillance System advisory service may be given at designated aerodromes;
- g. a continuous listening watch on the appropriate ATS frequency in access corridors or broadcast frequency in lanes is mandatory;
- h. two way operations are conducted with all traffic keeping to the right of the central geographical/topographical feature(s) as detailed in ERSA;
- i. the aircraft captain has the responsibility to ensure that operations are confined within the boundaries of the corridor or lane;
- j. the limits of corridors and lanes must be adhered to, with any transitional altitude requirements maintained within an accuracy of  $\pm 100$ FT;
- k. a helicopter not confining its operations to an access corridor will require ATC clearance and, while outside the corridor, will be subject to separation standards as applied by ATC.

*Note: Subject to environmental noise considerations, the imposition of limitations on those types of helicopters which exceed the noise limits specified in ICAO Annex 16 Vol 1 may be necessary.*

#### 10.15.5 Arrivals

10.15.5.1 At a controlled aerodrome, prescribed entry "gates" and associated standard routes and/or altitudes may be provided to facilitate the flow of helicopter traffic. Procedures for their use will be promulgated in ERSA. Use of these "gates" is not mandatory. Subject to the receipt of an ATC clearance, helicopters may, if required, conform to the standard traffic procedures applicable to aeroplanes. This option may be more appropriate when operating larger helicopters.

10.15.5.2 At locations within controlled airspace, helicopters may be granted a landing clearance or be instructed to report on the ground, as appropriate, at any area nominated by ATC or the pilot, and assessed by the pilot as being suitable as a HLS.

10.15.5.3 Unless requested by the pilot, a landing clearance will not be issued for a helicopter if the tailwind component exceeds 5KT.

10.15.5.4 At night a helicopter should not land at a site other than one which conforms with the requirements specified in the latest issue of AC 139.R-01. Any illuminated runway or illuminated taxiway of

dimensions commensurate with the size of the helicopter landing site applicable to the helicopter, in accordance with AC 139.R-01, is considered to meet the requirements of AC 139.R-01.

10.15.5.5 At a non-controlled aerodrome in VMC by day applicable to the aircraft category, helicopters need not join the circuit via standard aeroplane entry procedures, at the pilots discretion. As an alternative, under such conditions, helicopters may join the circuit area at 500FT above the surface from any direction subject to the normal restrictions of flight over populous areas. Helicopters must avoid other circuit traffic and descend to land at any location assessed by the pilot as being suitable for use as a HLS, provided:

- a. the intended landing point is located outside the flight strip of the runway in use;
- b. the final approach is clear of the extended centreline of the runway in use;
- c. post-landing positioning of the helicopter is by air transit or by taxiing as appropriate.

10.15.5.6 Pilots of radio equipped helicopters must broadcast intentions on the appropriate frequency as specified in [Section 10.3](#).

**10.15.6 Circuit Procedures**

10.15.6.1 At controlled aerodromes any specific operating procedures applicable to the helicopter traffic pattern will be detailed in ERSA. The following generally applies:

- a. where possible, helicopter circuit traffic will be separated from the aeroplane traffic pattern by the use of contra-direction circuits, outside of and parallel to the flight strip of the runway in use, and at a lower altitude than other traffic, but not below 500FT above the aerodrome elevation; or
- b. when separate circuit patterns are not practicable, helicopters may utilise the same traffic pattern direction as other traffic, and will normally operate inside and at a lower altitude than that traffic, but not below 500FT above the aerodrome elevation.

10.15.6.2 At non-controlled aerodromes the following circuit operating procedures apply:

- a. helicopters may be operated on contra-direction circuits and parallel to the aeroplane traffic pattern at a lower altitude than that traffic, but not below 500FT above the aerodrome elevation. The landing site associated with the helicopter circuit is to be positioned outside the flight strip of the runway in use so that helicopter circuit traffic does not cross the extended centre line of that runway;
- b. if the procedure outlined in sub-paragraph 10.15.6.2a. is not practicable, the helicopter circuit patterns should be flown inside and parallel to the aeroplane traffic and at lower altitudes, but not below 500FT above the aerodrome elevation. The landing site associated with the helicopter circuit must be positioned outside the flight strip of the runway in use so that helicopter circuit traffic does not cross the extended centre line of that runway; or
- c. the helicopter must follow the standard aeroplane traffic pattern and, in this case, may use the flight strip area of the runway in use;
- d. the pilots of radio equipped helicopters must broadcast their intentions and listen out for other traffic on the appropriate frequency.

**11. PROCEDURES WHEN ATS TEMPORARILY NOT AVAILABLE**

**11.1 Traffic Information Broadcast by Aircraft (TIBA)**

**11.1.1 TIBA procedures**

11.1.1.1 TIBA procedures are intended to permit reports and relevant supplementary information of an advisory nature to be transmitted by pilots for the information of pilots of other aircraft in the vicinity.

**11.1.2 Frequency**

11.1.2.1 Aircraft must maintain a listening watch on the appropriate TIBA frequency. Where VHF is used for air-ground communications with ATS and an aircraft has two serviceable VHF sets, one must be tuned to the appropriate ATS frequency and the other to the TIBA frequency.

11.1.2.2 The appropriate TIBA frequencies are:

Flight Profile	TIBA Frequency
At or above FL200	128.95 MHz
Below FL200	
– In continental Class G airspace	Relevant Area VHF
– Otherwise	126.35 MHz

### 11.2 Listening Watch

11.2.1 A listening watch must be maintained on the TIBA frequency 10 minutes before entering the designated airspace until leaving this airspace. For an aircraft taking off from an aerodrome located within 10 minutes flying time of that airspace, listening watch must start as soon as practicable after takeoff.

### 11.3 Time of Broadcasts

11.3.1 Broadcasts must be made:

- a. 10 minutes before entering the designated airspace or, for an aircraft taking off from an aerodrome located with 10 minutes flying time of the airspace, as soon as practicable after takeoff;
- b. 10 minutes prior to crossing a reporting point;
- c. 10 minutes prior to crossing or joining an ATS contingency route;
- d. at 20-minute intervals between distant reporting points;
- e. 2 to 5 minutes, where possible, before a change in flight level;
- f. at the time of a change in flight level; and
- g. at any other time considered necessary by the pilot.

### 11.4 Acknowledgment of Broadcasts

11.4.1 Broadcasts should not be acknowledged unless a potential collision risk exists.

### 11.5 Changes of Cruising Level

11.5.1 Cruising level changes should not be made within the designated airspace, unless considered necessary by pilots to avoid traffic conflicts, for weather avoidance or for other valid operational reasons.

11.5.2 When changes to cruising level are unavoidable, all available aircraft lighting which would improve the visual detection of the aircraft must be displayed while changing levels.

11.5.3 When a change of level is anticipated or initiated, a change of level report must be made. When the new level is reached, a report advising that the aircraft is maintaining the new level must be made.

### 11.6 Collision Avoidance

11.6.1 If, on receipt of a traffic information broadcast from another aircraft, a pilot decides that immediate action is necessary to avoid an imminent collision risk to the aircraft, and this cannot be achieved in accordance with the right of way provisions or TCAS resolution, the pilot should:

- a. unless an alternative manoeuvre appears more appropriate, immediately descend 1,000FT if above FL410, or 500FT if at or below FL410;
- b. display all available aircraft lighting which would improve the visual detection of the aircraft;
- c. as soon as possible, reply to the broadcast advising action being taken;
- d. notify the action taken on the appropriate TIBA frequency; and
- e. as soon as practicable, resume normal flight level, notifying the action on the appropriate TIBA frequency.

**11.7 Position Reporting**

11.7.1 Normal position reporting procedures should be continued at all times, regardless of any action taken to initiate or acknowledge a traffic information broadcast.

11.7.2 A position report must be made on the next CTA/Area VHF 15 minutes prior to leaving airspace in which TIBA procedures apply to obtain a clearance or re-establish SARWATCH on the appropriate ATS frequency.

**12. MANDATORY BROADCAST PROCEDURES (ATS TEMPORARILY NOT AVAILABLE)**

12.1 When ATS is temporarily not available, mandatory broadcast procedures may be specified in addition to TIBA broadcasts.

12.2 When arriving or departing from an aerodrome where mandatory broadcast procedures apply, pilots must monitor the appropriate mandatory broadcast frequency. Broadcasts must be made as follows:

Situation	Phrase
<b>1. Broadcasts</b> When a pilot broadcasts intentions.	<b>ALL STATIONS (location) (appropriate information)</b>
<b>2. Taxi</b> Taxiing at an aerodrome.	<b>(aircraft type) TAXIING (location) RUNWAY (number) FOR (destination, or departure quadrant or intention)</b>
<b>3. About to Commence Takeoff</b>	<b>LINING UP/ROLLING (runway number) TURNING (left/right) TRACKING (quadrant) CLIMBING TO (level)</b>
<b>4. Departing</b>	<b>DEPARTED (location) TRACKING (degrees magnetic) CLIMBING TO (level) FOR (destination)</b>
<b>5. Inbound</b> When inbound - before crossing the boundary of the area in which mandatory broadcasts apply.	<b>(Aircraft type) (position reported as either the radial, bearing or quadrant from the aerodrome) (level) (intentions)</b>
<b>6. Joining the Circuit</b>	<b>(Aircraft type) JOINING (position in circuit) RUNWAY (number)</b>

12.3 Pilot discretion should be used in making other than the prescribed calls to assist other traffic; e.g. executing a missed approach, or position in the circuit area, or leaving levels designated on TMA routes.

**13. ADF - UNLIT MILITARY AIRCRAFT OPERATIONS**

**13.1 Use of Night Vision Goggles**

13.1.1 The use of Night Vision Goggles requires modifications to aircraft lighting. Masking or extinguishing external lighting may create problems for other airspace users and for Air Traffic Control in providing visual separation.

13.1.2 Flights operating unlit or with masked external lighting shall advise the area of operations and operating band of levels in the flight notification.

14. RAAF - MARITIME SURVEILLANCE FLIGHTS

14.1 AP-3C Orion and P-8A Poseidon Operations

14.1.1 RAAF AP-3C Orions and P-8A Poseidons, when engaged in maritime surveillance of the Australian Economic Exclusion Zones (AEEZ), normally operate in accordance with procedures as outlined below.

Figure 1 - Australian Economic Exclusion Zones

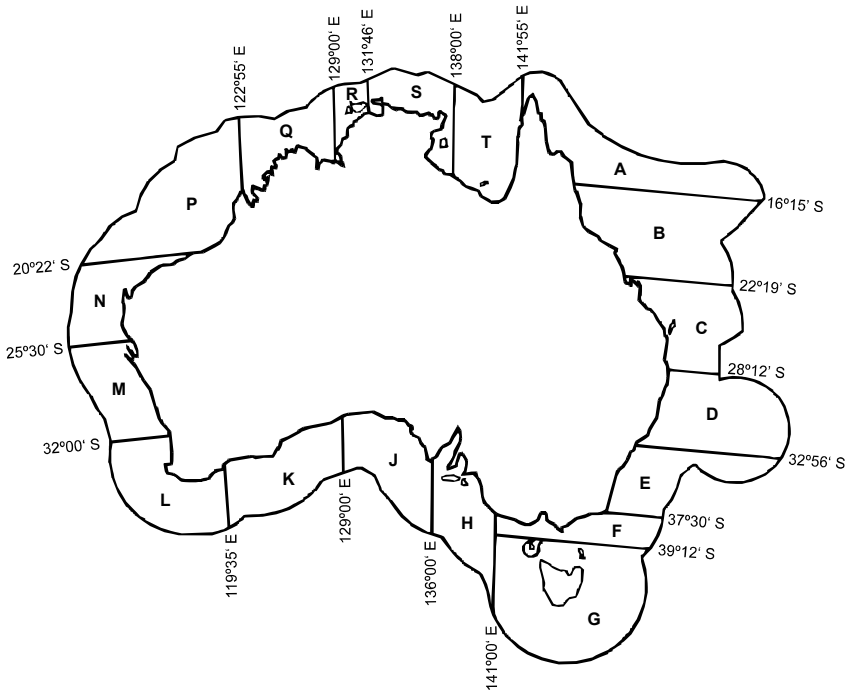

14.1.2 AP-3C Orions and P-8A Poseidons shall advise when changing to or from the Defence Communications Station Canberra (DCSC) frequencies.

14.1.3 During the surveillance stage, AP-3C Orions and P-8A Poseidons maintain guard on the Defence Communications Station Canberra (DCSC) frequencies and will monitor;

- a. area VHF frequency (if available); or
- b. 121.5 MHZ; and
- c. VHF-FM marine CH16 (156.8 MHZ); and
- d. 243.0 MHZ.

14.1.4 To assist AP-3C Orions and P-8A Poseidons to maintain separation from civil aircraft, transponder equipped aircraft should activate their transponder on code 4000 whilst operating in excess of 15NM off-shore OCTA. There is no requirement for traffic information to be passed to AP-3C Orions and P-8A Poseidons.

14.1.5 AP-3C Orions and P-8A Poseidons are authorised to use civil frequencies to submit in-flight SURSIGHT reports. These reports shall be handled in the same manner as for civil SURSIGHT reports.

## 15. RAAF - MLJ OPERATIONS

### 15.1 Operational Information

15.1.1 Low Jet Route (LJR) flights may be undertaken anywhere in Australia. The routes are planned to avoid:

- a. controlled airspace administered by Airservices Australia
- b. civil restricted and danger areas;
- c. civil aerodromes listed in ERSA, by at least 5NM laterally or 4,000FT vertically;
- d. Broadcast Areas in Class G airspace, unless equipped with the appropriate radio communications; and
- e. Military Sensitive areas (refer Airservices DAH) and oil/gas production facilities.

*Note: On occasions transit through areas listed above may occur with appropriate notification and clearance.*

15.1.2 Normally MLJ aircraft on LJR will remain within 5NM of track. However, on occasions, which shall be appropriately notified, these aircraft may require a larger track diversion for weather or training purposes.

15.1.3 MLJ aircraft will make good turning point estimates with a tolerance of  $\pm 2$ MIN.

15.1.4 Whenever practicable a broadcast of the progress of LJR aircraft shall be made on appropriate area VHF frequencies by ATS units. The purpose of this broadcast is to alert pilots who are listening out, but who may not have submitted flight notification or be in receipt of NOTAM regarding the MLJ aircraft. Planned level shall be used in the broadcasts, e.g. 350AGL; or the broadcast may refer to the flight as "LOW LEVEL MILITARY OPERATIONS".

15.1.5 If the MLJ aircraft is forced to abort the LJR, the aircraft will climb to a suitable altitude and assume normal reporting as soon as possible.

15.1.6 By definition, LJR include operations up to 5,000FT AGL. However, when MLJ aircraft intend to operate on LJR with manoeuvres above 5,000FT AMSL, the higher level(s) shall be advised in the flight notification.

15.1.7 If operations are required which exceed the restrictions detailed, a temporary restricted area shall be promulgated by NOTAM.

15.1.8 Normally, manoeuvres will be limited to a maximum heading of 90° from flight planned track. However, some exercises will permit unrestricted heading changes, particularly on the part of a "bounce" aircraft. The "bounce" aircraft is free to submit a separate intersecting flight notification if desired; or can fly the "strike" aircraft's flight notification, provided adherence to track and time tolerance limits are maintained.

### 15.2 Notification of Routes

15.2.1 Each route should be notified by Operational Notification Message (OPN) to Airservices Australia which shall raise a NOTAM. OPS data may be supplemented by a facsimile of the route map. Normal flight planning requirements should be observed, using Latitude/Longitude presentation of turning points whenever possible.

## 16. ADF - FORMATION FLIGHTS

### 16.1 Military Formation Procedures

16.1.1 Military formations shall be described using the following terms:

- a. **Close formation.** A Close formation is considered to be one aircraft for ATC separation purposes. Separation between the formation and other aircraft is based on the lead aircraft.
- b. **Standard formation.** Aircraft in Standard formation may be manoeuvred up to 1NM laterally and longitudinally, and remain co-altitude with the lead aircraft. ATC separation is based on the outer edges of a rectangle 1NM either side and 1NM behind of the lead aircraft.
- c. **Block formation.** A Block formation type requires application of prearranged ATC separation standards.

- d. **In-trail formation.** Individual aircraft flown sequentially behind the lead aircraft, within a specified In-trail distance. ATC separation is based on In-trail procedures and the individual aircraft dispositions.
- e. **Pairs In-trail.** Two or more pairs of aircraft where each element pair is in close formation and elements are separated by an In-trail distance. ATC separation is based upon the individual pair dispositions as per a single aircraft.
- f. **In-trail distance.** The specified distance between individual aircraft or elements. For example, a four ship in '2nm trail' covers a total distance of 6nm.

### 16.2 Transponder operation

16.2.1 **Close or Standard formation.** When formations are in Close or Standard formation, separation is based on the lead aircraft and the following transponder settings are required:

- a. Formation lead squawks NORMAL
- b. All other formation aircraft squawk STANDBY

*Note: Aircraft may have functionality to disable Mode 3A/C and Mode S (air to ground) ATC replies in order to reduce ATC 'screen clutter'. Mode S (air to air) replies to other aircraft are required for TCAS to function.*

16.2.2 **In-trail formation.** The following transponder Mode 3A/C settings are required:

- a. Formation lead squawks NORMAL
- b. For aircraft 2NM or more apart:
  - 1) each element lead and single-aircraft elements squawk NORMAL
  - 2) wing aircraft in element Close or Standard formation squawk STANDBY.
- c. For aircraft less than 2NM apart:
  - 1) each element lead and single-aircraft elements squawk STANDBY
  - 2) wing aircraft in element Close or Standard formation squawk STANDBY.

16.2.3 **Block formation.** When operating a Block formation, the formation lead must liaise with ATC prior to flight to determine the most appropriate transponder operation. Formation lead should advise the airspace block requirements in the flight notification remarks.

16.2.4 **Split formation.** When an aircraft or element separates from a formation, the single-aircraft or element lead pilot must squawk NORMAL and the ATC-assigned code or airspace dependent code (ENR 1.6 refers) if a discrete code has not been assigned.

### 16.3 Separation with other aircraft

16.3.1 Separation between aircraft within a formation is the responsibility of the pilots within the formation.

16.3.2 Within controlled airspace the minimum vertical separation between formations and other aircraft is 1000FT at or below FL290, and 2000FT above FL290.

16.3.3 Formation leaders shall specify the formation type when requesting Airways Clearance and on first contact with an approach or departure control service; e.g.

- a. '(agency), (callsign), [Close, Standard] (other RTF requirements)'
- b. '(agency), (callsign), In-trail, [climbing to (level), descending to (level), maintaining (level), maintaining block (level) to (level)], (callsign) two [and three, to (number)] in two mile trail'.

*Note: The second example indicates that there is 2NM between each element of the formation.*

16.3.4 An ATC clearance is required prior to transitioning to a formation type that requires increased ATC separation, e.g. from Close to Standard or In-trail. ATC shall withhold clearance for the transition in instances when a formation change would compromise separation with other aircraft. ATC is to be advised when a transition to a closer formation is complete.



16.3.5 All formation aircraft are to maintain the same level as the formation lead aircraft unless climbing or descending In-trail, or operating within cleared block levels.

#### 16.4 Formation departures

16.4.1 All pilots are responsible for maintaining navigation tolerances IAW SID requirements. As such, each formation element pilot is obligated to follow the published track and level requirements so far as is reasonably practicable.

*Note: Standard formation, which includes 1NM lateral and longitudinal offset, may impact obstacle clearance requirements and separation standards within instrument procedures. RNP1 SID and STAR procedures make no allowance for formation aircraft with a lateral offset.*

16.4.2 ATC must advise formations when crosswind is 10KT or more when issuing clearance for runway line-up or take-off.

16.4.3 ATC should not cancel a take-off clearance for a formation once any pilot in the formation has commenced their take-off roll. Where an urgent safety situation warrants, ATC may issue an instruction to 'STOP IMMEDIATELY'; however, the decision to proceed or reject take-off rests with the formation pilots.

#### 16.5 Speed control

16.5.1 Contrary to MATS, ATC may apply a speed control to a military formation.

16.5.2 Pilots in a formation must advise ATC when an application of speed control cannot be complied with.

#### 16.6 In-trail formation procedures

##### 16.6.1 Pilot responsibilities.

- a. Lead must advise ATC of the In-trail distance.
- b. Lead is responsible for responding to ATC instructions.
- c. Pilots of individual formation aircraft must report to ATC any loss of ability to maintain trail separation from the preceding aircraft.
- d. Level and heading changes must commence over the same geographical position for each in-trail individual-aircraft or element.
- e. Lead must not unduly delay execution of ATC instructions whilst ensuring formation elements acknowledge instructions on formation channels.

##### 16.6.2 ATC responsibilities. When controlling in-trail formations, ATC should:

- a. assign formation departure headings close to the runway alignment for radar departures whenever practicable.
- b. not instruct pilots to break from the formation for approach unless requested by the pilot.
- c. vector aircraft using a maximum 60 degrees of heading change per instruction and not exceed 90 degrees of vector heading change. Heading change limits do not apply to air-to-air radar capable formation aircraft.
- d. assign a block altitude for the formation if holding is required.

16.6.3 Pilots requesting an In-trail 'AMG Formation Departure' require a radar departure with the following provisos:

- a. the assigned departure heading should be aligned to the runway heading as far as is practicable.
- b. subsequent heading changes should not be issued within 4nm from departure end of the runway.

### 16.7 Snake Climb procedures

16.7.1 Snake climb relies on accurate tracking and climb procedures to achieve an In-trail formation departures for aircraft without station keeping systems capability or similar surveillance system capability. Formation elements must commence take-off at successive pre-briefed intervals. Airborne, the formation Lead pilot must report to the formation passing A020, or any higher initial report as briefed, and passing each pre-briefed level. Formation element pilots must maintain at least 500FT vertical separation from the preceding element until the Lead pilot instructs elements to re-join to another formation type. Once the formation has re-joined to another formation type, all operations are as per requirements for that formation type. If the formation is unable to re-join, then the Lead pilot must notify ATC and each element is to proceed as subsequently cleared by ATC. Pilots are to request separate take-off and departure clearances if a visual re-join in VMC or IMC, if applicable, is not assured.

### 16.8 Formation touch and go landing

16.8.1 Contrary to ENR 1.4 2.2 Special Provisions, military ATC may authorise a formation touch and go landing when requested by the pilot using the callsign for the formation.

## 17. ADF - SPECIAL REQUIREMENTS FLIGHTS

### 17.1 Notification Requirements and Procedures

17.1.1 A Special Requirements flight is one that:

- a. has limited COM/NAV equipment;
- b. limited fuel endurance; or
- c. any flight so deemed by an appropriate authority.

17.1.2 In all cases a Special Requirements flight shall be indicated in the flight notification. Refer to ENR 1.10 Appendix 2 Flight Notification - Users Guide, and Item 18 (military supplement), for instructions to include Special Requirements in a flight notification.

17.1.3 For the climb phase of the Special Requirements flight; start-up and set-heading times, which will permit unrestricted climb to cruising level, shall be nominated with acceptable limits within which these times may be varied. These limits normally should be not less than 10MIN either side of the nominated times.

17.1.4 Clearances issued to these flights shall, as far as possible, permit the operation to proceed in accordance with the flight notification. This includes the following requirements;

- a. planned routing or prescribed alternative routing;
- b. pilot selected levels;
- c. unrestricted climb to cruising level; and
- d. through clearance to destination.

17.1.5 In order that a clearance may be issued to permit the application of these procedures, captains of Special Requirements flights are to negotiate a clearance with ATC prior to engine start.

17.1.6 If, after negotiation, the coordinating authority indicates that an unrestricted climb at the desired departure time or within the acceptable limits will not be available, the earliest available time or an alternative departure procedure shall be nominated. If agreement still cannot be reached by negotiation, the matter shall be referred to the parent command of the operating unit.

17.1.7 An engine start approval shall be obtained from ATC.

17.1.8 If, after engine start, the captain of a Special Requirements flight receives any instructions which will require a change of flight notification, they shall, as soon as practicable, report the incident to ATC as an Air Safety Occurrence Report in accordance with MATS. The matter shall be then investigated and action taken to prevent recurrence.

17.1.9 Where the flight will traverse more than one control area, the initial clearance should normally cover flight through all such control areas. When it is not possible to clear the aircraft through successive control areas, the contents of the clearance shall clearly indicate this by reference to an appropriate clearance limit. Where other ATS units are concerned with control of the flight and communication conditions will not permit the necessary coordination of the clearance pre-flight, the pilot shall be required to obtain further clearances en route.

**18. ADF - RECALLING OF MILITARY AIRCRAFT**

18.1 Recalling of military aircraft due to weather may result from the notification to flying units of the existence of deteriorating or hazardous weather conditions. Responsibility for recalling aircraft shall be detailed in Local Instructions.

**19. RAAF - OPERATIONS FROM OPERATIONAL READINESS PLATFORMS**

19.1 Units requiring the use of an Operational Readiness Platform (ORP) for parking "readiness" aircraft and/or associated GSE shall obtain prior approval from the base XO/OSO, or deputy. Details of the XO/OSO's approval are to be passed to ATC.

19.2 When aircraft are parked overnight in an ORP, ATC shall ensure that a flashing red light is positioned in front of each aircraft parked in an ORP and two lights are positioned at the wing-tips.

19.3 Aircraft parked in an ORP may necessitate the use of a displaced threshold by other large aircraft. The displaced threshold shall be marked in accordance with normal procedures.

**20. ADF - OPERATIONAL CONTROL**

20.1 Operational Control of military aircraft shall be the responsibility of the relevant military authority, excepting provision of operational in-flight information in accordance with MATS. Significant changes in the route planned by military aircraft shall not be required without prior consultation with the responsible liaison officer of the military unit. A military flight which has submitted IFR flight notification but whose operations may preclude compliance with the IFR shall be treated as being IFR throughout all stages of the flight unless otherwise advised.

**21. RAAF - AIR-TO-AIR REFUELLING**

**21.1 Purpose**

21.1.1 The following provisions cover the policy and criteria for the establishment of Air-to-Air Refuelling (AAR) tracks and anchors, and the air traffic control aspects of AAR operations within controlled airspace.

**21.2 Definitions**

21.2.1 The following definitions are specific to this chapter only:

**AAR Exit Point (A/R Exit Point):** The designated geographic point at which the refuelling track terminates.

**AAR Rendezvous (RV):** The procedures employed to enable the receiver(s) to reach the astern position behind the assigned tanker(s) for boom operations, or the observation position for drogue operations, by electronic, radio, and/or visual means.

**AAR Track:** A prescribed route designated for AAR.

**Anchor Point:** A defined reference point upon which an anchor refuelling pattern is orientated.

**Anchor Refuelling:** AAR performed as the tanker(s) maintain a prescribed pattern, which is anchored to a geographical point or fix.

**RV Control Point (RVCP):** The planned geographic point over which the receiver(s) arrive in the observation/astern position with respect to the assigned tanker.

**RV Control Time (RVCT):** The planned time that the receiver and tanker will arrive over the RVCP.

**RV Initial Point (RVIP):** A planned geographic point prior to the RVCP to which tankers and receivers time independently to effect an arrival at the RVCT.

### 21.3 General

21.3.1 Published AAR tracks and anchor patterns within Australian FIRs are promulgated in the Designated Airspace Handbook (DAH), Military AAR & AEW&C Airspace (MAAA). AAR tracks shall align with established airways wherever feasible; however, the AAR route name shall be for AAR use only. Additional waypoints specific to the AAR usage of the route will be uncharted on civil maps and databases. Where it is not practicable to align an AAR track with existing airways, a special track will be established IAW section 6.

21.3.2 The establishment of an AAR track or anchor does not preclude the use of that airspace by other aircraft. ATC shall apply standard separation between the AAR elements/formations and other airspace users, as appropriate.

### 21.4 Track Requirements

21.4.1 An AAR track consists of an RVIP, RVCP, and an A/R Exit Point. A tanker orbit pattern is usually flown at the RVCP until the receiver arrives, although the tanker may manoeuvre as required within the Tanker Manoeuvring Area to facilitate the RV between tanker and receiver aircraft. Navigation check points between the RVCP and A/R Exit Point are specified, as required, to facilitate navigation along the route and serve as fuel checkpoints. Tracks may be used in either direction unless the track is designated a one-way route in the DAH.

Figure 75.1: AAR Track Components

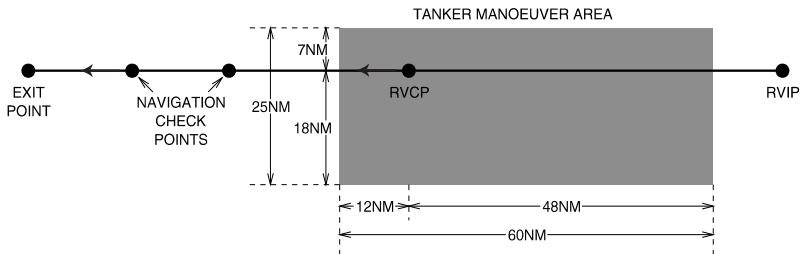

21.4.2 **Tanker Manoeuvre Area.** The tanker manoeuvre area for a track is contained within the airspace defined by a rectangle 60NM in length (48NM up-track and 12NM down-track from the RVCP) and 25NM wide (7NM on non-holding side and 18NM on holding side of the pattern), orientated longitudinally along the RVIP-RVCP segment, as shown in Figure 75.1. The tanker will fly a left handed orbit pattern within this area but will modify leg lengths and turn rates as required to affect the RV. Unless otherwise requested and approved, all manoeuvres associated with establishing the AAR formation will occur within the published tanker area and the assigned altitude block. The Tanker Manoeuvre Area is designed to facilitate the establishment of the formation only. Once the RV has been completed the formation will continue along track, as indicated by the direction arrows, refuelling as required.

### 21.5 Anchor Requirements

21.5.1 The standard AAR anchor pattern consists of a left hand racetrack with legs separated by at least 10NM. The standard length for this pattern is 50NM; however the pattern may be modified to meet surrounding airspace requirements.

21.5.2 Anchor patterns within Australian FIRs are published in DAH along with the airspace geographical points that define the lateral limits of the AAR area. Unless otherwise requested and approved, manoeuvres associated with conducting AAR shall occur within the lateral limits of the AAR area and assigned altitude block.

**Figure 75.2: Anchor Pattern Components**

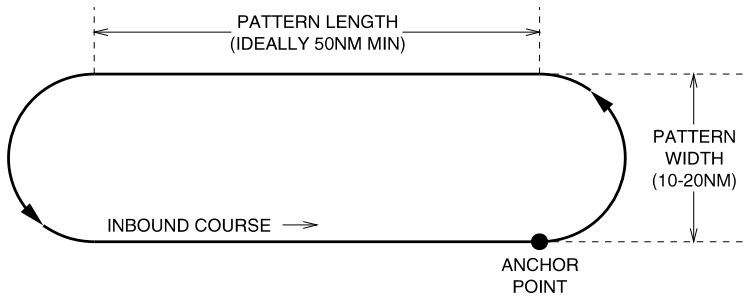

21.5.3 The anchor point, the orientation of the inbound course and the pattern length, as shown in Figure 75.2, determine the location and size of the pattern.

**21.6 AAR Track and Anchor Pattern Establishment**

21.6.1 Requests to establish AAR tracks and anchors outside Restricted Airspace will be generated by the ADF AAR Action Group and will be coordinated through the Directorate of ADF Airspace Management to the affected Airservices Australia Air Traffic Control unit.

21.6.2 Considerations and criteria for establishment of AAR tracks and anchor patterns are as follows:

- a. AAR store extension and retraction (boom), or deployment and stowage (drogue), should not be planned or performed over 'built-up' areas.
- b. AAR tracks may be established in either direction.
- c. Where practicable, tracks will be established coincident with established airways, however when the AAR Action Group determine established airways to be impracticable, the new track(s) shall be based on the required geographical coordinates.
- d. Unless adjacent AAR tracks are vertically separated from each other, tracks shall be established with at least 30NM between track centrelines. Appropriate separation shall be applied between individual AAR formations unless MARSA is in use.

21.6.3 The following guidance is provided for Simultaneous Opposite Direction Air to Air Refuelling (SODAR):

- a. Simultaneous refuelling in opposite direction may be authorised between single AAR tracks, which are vertically separated by a minimum of 2,000FT between altitude blocks.
- b. Where SODAR is authorised on an established track it will be annotated accordingly in the DAH.
- c. SODAR tracks should be established for bi-directional use to permit course reversals without requiring altitude changes.

21.6.4 Once Airservices Australia confirms acceptance of the AAR track and/or anchor establishment, the AAR Action Group shall submit a DAH amendment through AIS-AF.

21.6.5 Where published tracks and anchors are not practicable for a specific mission, a special track or anchor may be established through direct coordination with the appropriate ATC unit Supervisor/Manager for the airspace in which the mission will be flown. If a special track or anchor is required on a more frequent basis, the planning provisions for the establishment of the track or anchor in the DAH shall be followed.

## 21.7 Flight Planning

21.7.1 The following data is to be included on flight plans by all AAR participating aircraft in circumstances when the AAR mission will occur outside Restricted Airspace:

- a. Block levels;

*Note: The block levels for the AAR portion of the flight shall be annotated into Item 15 of the Tanker's flight plan as required by Appendix 2 – ATS Flight Notification – Users Guide (FIHA) as follows:*

***C(RVCP identifier)/N0275F230F250**, where C indicates the requirement for a block level at the RVCP, followed by the AAR TAS in knots, then the lower and upper levels of the altitude reservation. This is to permit at least 1000FT vertical separation between the tanker's lowest altitude and the associated receiver's altitude, from the RVIP to the RVCP for an AAR Track, or at the anchor point for anchor pattern AAR.*

- b. RVCP or anchor point;

*Note: Tanker may file DCT to the RVCP if required.*

- c. RVIP (if required);

*Note: Receiver shall file via the RVIP for Track AAR.*

- d. Duration of delay at RVCP for Track AAR;

*Note: The AAR Track delay is normally only applicable to the tanker. The delay en-route is annotated in item 18 of the flight plan as follows: **DLE (RVCP identifier)0015**. This signifies as a remark that the tanker will delay en-route at the RVCP for 15 minutes.*

- e. Duration of delay at Anchor Point for Anchor AAR;

*Note: For anchor refuelling both the tanker and the receivers will file the delay at the anchor point as per the previous note.*

- f. Track or anchor designator;

- g. Track or anchor exit point; and

- h. MARSAs elements.

*Note: Refer to ENR 1.10 Flight Notification - User Guide (military supplement) for instructions and an example, to include AAR operations in the flight plan.*

## 21.8 Operations

21.8.1 All AAR operations outside Restricted Airspace shall be conducted on an IFR flight plan at assigned levels. If additional altitudes are required, prior clearance shall be obtained from the relevant ATC facility.

21.8.2 MARSAs procedures as detailed in ENR 1.1 sub-section 10.14.9 apply for AAR operations. Non-participating aircraft may be cleared through AAR airspace subject to the application of ATC separation standard(s) between the AAR aircraft/formation and other traffic.

21.8.3 Due to the limited manoeuvrability of an AAR formation, ATC initiated heading assignments and altitude changes may not be effected without the concurrence of the tanker.

21.8.4 Each aircraft/formation, as applicable, must receive an airways clearance prior to departing the AAR track or anchor pattern. If clearance is not available:

- a. The tanker and receiver(s) will remain in formation and continue in accordance with the tanker's airways clearance until a clearance to separate from the formation is obtained; and
- b. The Tanker shall request an extension of the AAR track, if required.

*Note: AAR is to be terminated by the exit point unless an extension of the AAR track has been received.*

21.8.5 **Tanker Responsibilities.** The tanker captain is responsible for:

- a. remaining within 2NM of the assigned AAR track centreline, or within the airspace designated for anchor AAR;
- b. notifying ATC of all altitudes within the assigned block that are no longer required;

- c. receiver navigation from the RV to the cessation of MARSAs;
- d. maintaining communications with the appropriate ATC facility;
- e. all communications during refuelling operations, including those concerning the receivers;
- f. obtaining on-wards clearance from ATC for all formation elements prior to the cessation of MARSAs;
- g. vertically positioning aircraft within the assigned altitude block prior to reaching the planned exit point, to facilitate the transfer of separation responsibility back to ATC; and
- h. coordinating revised AAR times and/or tracking details with ATC if unable to meet original planned mission objectives.

21.8.6 **Receiver Aircraft Responsibilities.** The receiver aircraft captain or formation lead is responsible for:

- a. initiating the request for altitude change in sufficient time to reach the required altitude prior to the RVIP;
- b. squawking normal when separation from tanker is greater than 2 miles or as otherwise directed by ATC; and
- c. maintaining two-way contact with ATC until released by ATC to the tanker, and from the cessation of MARSAs for the remainder of the flight, unless otherwise approved (e.g. NOCOM).

21.8.7 **ATC Responsibilities.** The appropriate ATC unit shall:

- a. ensure that ATC separation exists between tanking elements until MARSAs is declared by the tanker;
- b. ensure that ATC separation exists between tanking elements and other airspace users, including during manoeuvres within the Tanker Manoeuvre Area to facilitate the RV;
- c. provide assistance, upon request, to either receiver or tanker on the other aircraft's position;
- d. not issue heading/level changes to the AAR formation without the concurrence of the tanker captain; and
- e. ensure that ATC separation exists prior to the tanker/receiver terminating MARSAs.

21.8.8 **AAR Track Chronology.** The following details the sequence of events for track operations:

- a. Tanker requests delay at the RVCP and advises ATC of the requested AAR block altitudes;  
*Note: If ATC advises 'CLEARED DELAY AT (RVCP identifier)', the tanker will enter the orbit pattern as described in paragraph 21.4.2. However, if a 'HOLD' instruction is issued by ATC, the tanker shall enter a standard holding pattern or unless instructed otherwise by ATC.*

- b. ATC approves delay at the RVCP by use of the phrase 'DELAY APPROVED' and issues a clearance for the AAR block;
- c. Tanker enters orbit pattern airspace for delay at RVCP;
- d. Well before the receivers reach the RVIP, receivers are cleared to the next level below the AAR block, ensuring that ATC vertical separation is maintained;
- e. Tanker declares MARSAs;
- f. ATC releases receiver to AAR frequency not later than the RVIP;

*Note: AAR frequency will be as per assigned frequency for track or pattern promulgated in the DAH. ATC will refer to this as 'AAR FREQUENCY'. Upon release to AAR frequency there is no requirement for the receiver to maintain or monitor the ATC frequency. The tanker assumes responsibility for all formation communications with ATC.*

- g. Tanker instructs receivers to climb into AAR block.
- h. ATC issues clearance to tanker for the formation to conduct AAR along the track, and issues block clearance, if not previously assigned;

- i. ATC ensures that non-participating aircraft remain clear of the elements within the tanker manoeuvring area until the tanker advises that the RV is complete;
- j. Tanker and receiver aircraft complete RV in accordance with extant procedures and proceed down track;
- k. Tanker advises ATC of tanker and receiver post-AAR clearance requests, including amended routing and levels, if applicable, at least five minutes prior to either the exit point or the expected cessation of AAR formation activities;
- l. At or prior to the exit point, ATC issues tanker and receiver airways clearances;
- m. Prior to the exit point the tanker vertically positions the aircraft in the formation within the assigned block altitude to restore ATC separation;
- n. MARSA is terminated once standard ATC separation is established and confirmed by the ATC unit. Individual elements continue as per airways clearance.

21.8.9 **Anchor AAR.** Anchor AAR operations involve the same basic procedural elements as required for track AAR, except that both tanker and receiver aircraft file a delay in the anchor area and all AAR activity including the join is conducted within the defined airspace.



21.8.10 **Phraseology.** Standard calls between ATC and AAR aircraft are detailed as follows:

Circumstances	Phraseology * Denotes Pilot Transmission
Tanker approaching RVCP – Requesting Delay	*REQUEST DELAY AT ( <i>RVCP identifier</i> ) UNTIL ( <i>RVCT</i> ) (or FOR UP TO ( <i>number</i> ) MINUTES)  CLEARED DELAY AT ( <i>RVCP identifier</i> )
Tanker accepting MARSAs	*( <i>tanker call-sign</i> ) ACCEPT MARSAs WITH ( <i>receiver call-sign</i> )  ( <i>tanker call-sign</i> ) MAINTAIN BLOCK ( <i>level</i> ) TO ( <i>level</i> ), MARSAs ( <i>receiver call-sign</i> )  ( <i>receiver call-sign</i> ) MAINTAIN BLOCK ( <i>level</i> ) TO ( <i>level</i> ), MARSAs ( <i>tanker call-sign</i> )
Receiver released to AAR frequency	( <i>receiver call-sign</i> ) CONTACT ( <i>tanker call-sign</i> ) ON AAR FREQUENCY
Tanker requesting clearance for AAR (approaching RVIP/RVCP)	*REQUEST AAR ON ( <i>AAR track</i> ), [BLOCK LEVEL ( <i>level</i> ) TO ( <i>level</i> ) if not previously issued] WITH ( <i>receiver call-sign</i> )  ( <i>tanker and receiver call-sign</i> ) CLEARED TO CONDUCT AAR ON ( <i>track</i> ) BLOCK ( <i>level</i> ) TO ( <i>level</i> )
Requesting AAR between random positions (not on promulgated AAR tracks)	*REQUEST RANDOM AAR BETWEEN ( <i>reporting points or radial/ranges</i> ) BLOCK LEVEL ( <i>level</i> ) TO ( <i>level</i> ) WITH ( <i>receiver call-sign</i> )  CLEARED TO CONDUCT RANDOM AAR BETWEEN ( <i>reporting points or radial/ranges</i> ) BLOCK ( <i>level</i> ) TO ( <i>level</i> ) WITH ( <i>receiver call-sign</i> )
	Upon receipt of clearance Tanker aircraft assumes all responsibility for ATC communications and navigation. All aircraft involved in AAR at this stage will be referred to as: ( <i>tanker call-sign</i> ) FLIGHT
Approaching Exit Point/termination of AAR (not later than five minutes prior)	*( <i>tanker call-sign</i> ) FLIGHT APPROACHING END AAR. ( <i>tanker call-sign</i> ) REQUEST ( <i>onwards clearance</i> ), ( <i>receiver call-sign</i> ) REQUESTS ( <i>onwards clearance</i> )  Prior to reaching end AAR point/Exit point, Tanker and Receiver will proceed to the top/bottom of the block altitudes/flight levels respectively  Prior to end AAR point/Exit point ATC will provide clearance information for Tanker and Receiver to Tanker aircraft. Tanker aircraft reads back both clearances then advises Receiver of current radio frequency/onwards clearance.
Post AAR	*( <i>tanker call-sign</i> ) FLIGHT LEVEL ( <i>top of block</i> ), MARSAs ( <i>receiver call-sign</i> )
Receiver check-in with ATC post AAR	*( <i>receiver call-sign</i> ) FLIGHT LEVEL ( <i>bottom of block</i> ), MARSAs ( <i>tanker call-sign</i> )
MARSAs terminated	( <i>tanker and receiver call-sign</i> ) MARSAs TERMINATED

22. RAAF - AIRBORNE EARLY WARNING AND CONTROL (AEW&C) OPERATIONS

22.1 Purpose

22.1.1 The following provisions cover the policy and criteria for the establishment of Airborne Early Warning and Control (AEW&C) orbits, and the air traffic control aspects of AEW&C operations within controlled airspace.

22.2 Definitions

22.2.1 The following definitions are specific to this chapter only:

**Airspace Geographical Points.** Airspace Geographical Points (latitude/longitude) define the area in which the AEW&C orbit pattern is to be flown. AEW&C aircraft will be able to operate laterally within this rectangular airspace freely up to the boundary.

**Anchor Point.** A defined reference point around which a generic AEW&C orbit is orientated.

**IB Course.** The course inbound to the defined anchor point for the AEW&C orbit.

**Orbit Pattern.** Four latitude/longitude coordinates that define the area of the generic racetrack AEW&C orbit pattern.

22.3 General

22.3.1 Published AEW&C orbit patterns within the Australian Flight Information Regions are promulgated in the Designated Airspace Handbook (DAH), Military AAR & AEW&C Airspace (MAAA).

22.3.2 The establishment of an AEW&C orbit does not preclude the use of that airspace by other aircraft. ATC shall apply standard separation between the AEW&C aircraft and other airspace users, as appropriate.

22.4 AEW&C Orbit Requirements

22.4.1 The standard AEW&C orbit consists of a left or right hand racetrack, or a figure eight pattern, with legs separated by approximately 10NM. The standard length for this pattern is 70NM; however the pattern may be modified as required by either the aircraft Flight Crew or Air Traffic Control to meet surrounding airspace requirements and/or operational requirements.

22.4.2 Orbit patterns within the Australian Flight Information Regions are published in DAH along with the airspace geographical points that define the lateral limits of the AEW&C orbit area. Unless otherwise requested and approved, manoeuvres associated with conducting AEW&C orbits shall occur within the lateral limits of the AEW&C area and the ATC assigned altitude block.

22.4.3 The orbit, the orientation of the inbound course and the pattern length, as shown in Figure 76.1 and Figure 76.2, determine the location and size of the pattern.

Figure 76.1: AEW&C Standard Orbit Pattern

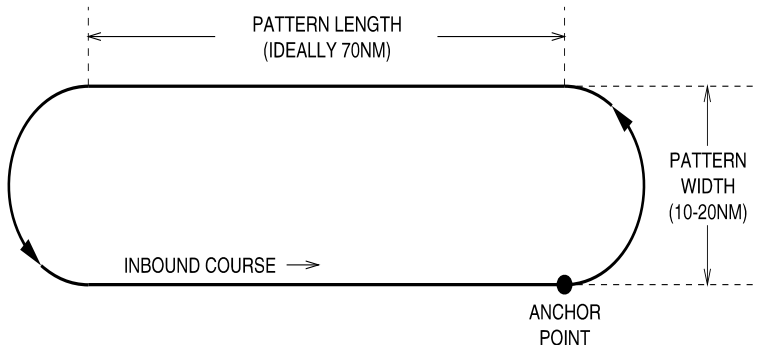
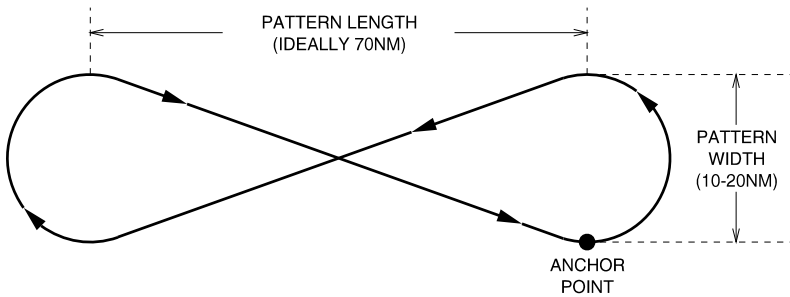

Figure 76.2: AEW&C Figure Eight Orbit Pattern



**22.5 Permanent Orbit Pattern Establishment**

22.5.1 Requests to establish permanent AEW&C orbit patterns outside restricted airspace will be administered by 42WG and coordinated through the Directorate of ADF Airspace Management in consultation with the affected Airservices Australia Air Traffic Control unit.

22.5.2 Considerations for the establishment of AEW&C orbit patterns are as follows:

- a. **Radar coverage of AEW&C aircraft by civil ATC.** This establishes the requirements for separation standards needed to be employed by civil ATC.
- b. **Operational requirements.** Are there operational requirements that preclude the unclassified publication of an AEW&C orbit pattern?
- c. **Civil Controlled airspace.** If establishing an AEW&C orbit pattern within civil controlled airspace, is it within a high density area that would create undue disruption to the civil airline industry?
- d. **Restricted Airspace.** Can the AEW&C orbit pattern be conducted within Australian Defence restricted airspace?

22.5.3 Once Airservices Australia confirms acceptance of the AEW&C orbit establishment, 42WG shall submit a DAH amendment through AIS-AF.

22.5.4 Where published orbits are not practicable for a specific mission, a special AEW&C orbit may be established through direct coordination with the appropriate ATC unit Supervisor/Manager for the airspace in which the mission will be flown. If a special AEW&C orbit is required on a more frequent basis, the planning provisions for the establishment of the orbit pattern in the DAH shall be followed.

**22.6 Operations**

22.6.1 All AEW&C orbit operations conducted outside restricted airspace but inside civilian controlled airspace shall be on an IFR flight plan at ATC assigned levels. If additional altitudes are required, clearance shall be obtained through the normal procedures from the relevant ATC facility.

22.6.2 AEW&C aircraft must be aware that operating within an orbit pattern does not give them priority over any civil traffic. ATC will attempt to issue clearances to mutually benefit all users of civilian controlled airspace. This may mean at times that AEW&C aircraft may not have access to their preferred altitudes and that the orbit pattern airspace may be modified at ATC discretion.

22.6.3 AEW&C aircraft that are cleared to track towards an orbit pattern must track direct to the designated anchor point for that pattern. If alternate tracking is required this must be requested through the normal ATC process.

22.6.4 AEW&C operations outside controlled airspace shall be conducted 'due regard' not under an IFR flight plan. Under these circumstances AEW&C aircraft are expected to provide their own separation.

## 22.7 Flight Planning

22.7.1 A flight plan shall be submitted to Airservices Australia for an AEW&C mission utilising designated orbit patterns.

The following data is to be included on the flight plan:

- a. ITEM 15 – Route – Details of the planned route;

*Note: The aircraft can be flown directly to the orbit pattern anchor point as defined in DAH by annotating this in item 15 of the flight plan e.g. **DCT 3101S15003E**.*

- b. ITEM 18 – Relevant Information:

- 1) Include as a **remark** the actual orbit pattern as per the DAH e.g.  
**RMK/WEDGETAIL ORBIT OPERATIONS WITHIN THE CONFINES OF WM95.**  
This signifies that the aircraft will be operated within the confines of the Wedgetail orbit airspace WM95, as per the DAH.
- 2) Include as a **delay** the intended time in the orbit pattern e.g.  
**DLE/WM95 0400.**  
This signifies that the aircraft will delay at the WM95 orbit pattern for 4 hours.

22.7.2 The AEW&C aircraft will track to the anchor point as per the submitted flight plan. Once at the anchor point the aircraft will conduct operations as required within the lateral confines of the AEW&C orbit pattern. Assigned altitudes will be issued in accordance with the flight plan or as requested in-flight.

## APPENDIX 1

POSITION REPORTS, AIREP SPECIAL,  
AND VOLCANIC ASH REPORTS1. **Position Reports**

Refer to *FORM 1: ROUTINE POSITION AND AIREP SPECIAL REPORTS*.

Section 1 is obligatory.

Section 2 must be added only when requested by the operator or deemed necessary by the pilot in command.

In the enroute phase, section 3 (other than braking action) should be added:

- a. by AMDAR equipped aircraft only - at designated compulsory MET reporting points, and
- b. when requested by ATC or MET.

At a controlled aerodrome, section 3 (braking action) should be reported when encountered runway braking action is not as good as reported.

2. **AIREP Special**

To be made whenever any of the phenomena listed under item 9 are observed or encountered. Items 1-4 and the appropriate phenomena specified in item 9 are the minimum required.

3. **Detailed reporting instructions for selected items**

Item 1: Use aircraft callsign as per flight plan or as requested by ATC.

Item 3: Time must be the actual time of the aircraft at the position, not the time of the message. Time shall be expressed in hours and minutes UTC.

Item 4: Aircraft on a block level, or climb, or descent clearance are to report actual flight level or altitude at the position plus level climbing/descending to.

Item 5: 'Next position' shall only be a compulsory reporting point or waypoint, unless ATC requests an estimate for a different place. Time shall be expressed in hours and minutes UTC.

Item 6: 'Ensuing significant point' shall be the next compulsory or non-compulsory reporting point or waypoint after the 'Next position'. This item is only required if requested or necessary to confirm route to be followed.

Item 9:

- Turbulence: The following specifications apply:

- Moderate: Changes to accelerometer readings of between 0.5 g and 1.0 g at the aircraft's centre of gravity. Moderate changes to aircraft attitude and/or altitude may occur but aircraft remains under positive control. Usually small changes in airspeed. Difficulty in walking. Loose objects move about.

- Severe: Changes to accelerometer readings greater than 1.0 g at the aircraft's centre of gravity. Abrupt changes to aircraft attitude and/or altitude may occur; aircraft may be out of control for short periods. Usually large changes of airspeed. Loose objects tossed about.

- Icing: The following specifications apply:

- Moderate: Conditions in which a change of heading and/or altitude may be considered desirable.

- Severe: Conditions in which immediate change of heading and/or altitude is considered essential.

- MOUNTAINWAVE SEVERE means conditions in which the downdraft is 600FT/MIN or more and/or severe turbulence is encountered.

- Thunderstorms: Only report those thunderstorms which are:
  - obscured in haze; or
  - embedded in cloud; or
  - widespread; or
  - forming a squall-line.
- Pre-eruption volcanic activity: In an AIREP, this means unusual and/or increasing volcanic activity which could presage a volcanic eruption.

*Note: In case of volcanic ash cloud, pre-eruption volcanic activity or volcanic eruption, a post-flight report shall also be made on the special air-report of volcanic activity form (Model VAR - see example in FORM 2: VOLCANIC ACTIVITY FORM (MODEL VAR)).*

- Braking action: The following specifications apply:
  - GOOD - Braking deceleration is normal for the wheel braking effort applied AND directional control is normal.
  - GOOD TO MEDIUM - Braking deceleration OR directional control is between Good and Medium.
  - MEDIUM - Braking deceleration is noticeably reduced for the wheel braking effort applied OR directional control is noticeably reduced.
  - MEDIUM TO POOR - Braking deceleration OR directional control is between Medium and Poor.
  - POOR - Braking deceleration is significantly reduced for the wheel braking effort applied OR directional control is significantly reduced.
  - LESS THAN POOR - Braking deceleration is minimal to non-existent for the wheel braking effort applied OR directional control is uncertain.

#### 4. Volcanic Ash Reports

Refer to *FORM 2: VOLCANIC ACTIVITY FORM (MODEL VAR)*.

AIREP are critically important for assessing the hazards of volcanic ash cloud to aircraft operations. Information recorded on the volcanic activity reporting form (Model VAR) is not for transmission by RTF but, on arrival at an aerodrome, is to be delivered without delay by the operator or a flight crew member to the aerodrome meteorological office. If such an office is not easily accessible, the completed form shall be delivered in accordance with local arrangements made between the meteorological and ATS authorities and the operator.

<b>FORM 1: ROUTINE POSITION AND AIREP SPECIAL REPORTS</b>			
	<b>ITEM</b>	<b>PARAMETER</b>	<b>TRANSMIT IN TELEPHONY as appropriate</b>
		Message-type designator: – Routine position-report – Special air-report	(callsign) POSITION [AIREP] SPECIAL
Section 1	1	Aircraft identification	<i>(aircraft identification)</i>
	2	Position	POSITION <i>(latitude and longitude)</i> OVER <i>(significant point)*</i> ABEAM <i>(significant point)</i> <i>(significant point) (bearing)</i> <i>(distance)</i>
	3	Time	<i>(time)</i>
	4	Level	FLIGHT LEVEL <i>(number)</i> or <i>(number) FEET*</i> CLIMBING TO FLIGHT LEVEL <i>(number)</i> or <i>(number) FEET*</i> DESCENDING TO FLIGHT LEVEL <i>(number)</i> or <i>(number) FEET*</i>
	5	Next position and estimated time over	<i>(position) (time)</i>
	6	Ensuing significant point (only if requested or necessary to confirm route to be followed)	<i>(position) NEXT</i>
Section 2	7	Estimated time of arrival	<i>(aerodrome) (time)</i>
	8	Endurance	ENDURANCE <i>(hours and minutes)</i>

	ITEM	PARAMETER	TRANSMIT IN TELEPHONY as appropriate
Section 3	9	Phenomenon encountered or observed, prompting a special air-report: – Moderate turbulence – Severe turbulence – Moderate icing – Severe icing – Severe mountain wave – Thunderstorms without hail – Thunderstorms with hail – Heavy dust/sandstorm – Volcanic ash cloud – Pre-eruption volcanic activity or volcanic eruption – On climb out or approach: – Cloud - unexpected significant variations to amount, base or tops (by reference to QNH); – Visibility - reduced due fog, mist, hail, rain, snow or dust, or improvement observed; – Wind - significant variation to forecast; – Other Phenomena - incidence of severe or moderate turbulence, thunderstorms, moderate or severe icing, hail, line squalls, standing waves or winds of 40KT or more within 2,000FT of ground level.	TURBULENCE MODERATE TURBULENCE SEVERE ICING MODERATE ICING SEVERE MOUNTAINWAVE SEVERE THUNDERSTORMS THUNDERSTORMS WITH HAIL DUSTSTORM <i>or</i> SANDSTORM HEAVY VOLCANIC ASH CLOUD PRE-ERUPTION VOLCANIC ACTIVITY <i>or</i> VOLCANIC ERUPTION (Plain language description)

\*In Australian domestic airspace, the words "OVER" and "FEET" may be omitted.



Section 3	9	Runway braking action:	BRAKING ACTION:
		- Good	- GOOD
		- Good to Medium	- GOOD TO MEDIUM
		- Medium	- MEDIUM
		- Medium to Poor	- MEDIUM TO POOR
		- Poor	- POOR
		- Less than Poor	- LESS THAN POOR

\*In Australian domestic airspace, the words "OVER" and "FEET" may be omitted.

<b>FORM 2: VOLCANIC ACTIVITY FORM (MODEL VAR)</b>		
OPERATOR:	ACFT IDENTIFICATION: (per flight plan)	PIC:
DEP FROM:	DATE:	TIME (UTC):
ARR AT:	DATE:	TIME (UTC):
ADDRESSEE:		AIREP SPECIAL:
<b>Items 1-8 are to be reported immediately to the ATS unit that you are in contact with.</b>		
1) Aircraft identification:	2) Position:	
3) Time:	4) FL or ALT:	
5) VOLCANIC ACTIVITY OBSERVED AT: (Position or bearing, estimated level of ash cloud and distance from aircraft)		
6) AIR TEMPERATURE:	7) SPOT WIND:	
8) SUPPLEMENTARY INFORMATION:  (Brief description of activity especially vertical and lateral extent of ash cloud and, where possible, horizontal movement, rate of growth, etc.)  SO2 detected   Yes <input type="checkbox"/> No <input type="checkbox"/> Ash encountered   Yes <input type="checkbox"/> No <input type="checkbox"/>		
<b>After landing complete items 9-16, then deliver to the aerodrome meteorological office or deliver in accordance with local arrangements made between the Meteorological, ATS authorities and the operator.</b>		
9) Density of ash cloud:	(a) Wispy <input type="checkbox"/>	(b) Moderate dense <input type="checkbox"/>
		(c) Very dense <input type="checkbox"/>
10) Colour of ash cloud:	(a) White <input type="checkbox"/>	(b) Light grey <input type="checkbox"/>
	(d) Black <input type="checkbox"/>	(e) Other <input type="checkbox"/>
11) Eruption:	(a) Continuous <input type="checkbox"/>	(b) Intermittent <input type="checkbox"/>
		(c) Not visible <input type="checkbox"/>
12) Position of activity:	(a) Summit <input type="checkbox"/>	(b) Side <input type="checkbox"/>
	(d) Multiple <input type="checkbox"/>	(e) Not observed <input type="checkbox"/>
13) Other observed features of eruption:	(a) Lightning <input type="checkbox"/>	(b) Glow <input type="checkbox"/>
	(d) Ash fallout <input type="checkbox"/>	(e) Mushroom cloud <input type="checkbox"/>
		(c) Large rocks <input type="checkbox"/>
14) Effect on aircraft:	(a) Communication <input type="checkbox"/>	(b) Navigation systems <input type="checkbox"/>
	(d) Pitot static <input type="checkbox"/>	(e) Windscreen <input type="checkbox"/>
		(c) Engines <input type="checkbox"/>
		(f) Windows <input type="checkbox"/>
15) Other effects:	(a) Turbulence <input type="checkbox"/>	(b) St. Elmo's Fire <input type="checkbox"/>
		(c) Other fumes <input type="checkbox"/>
16) Other information: (Any information considered useful)		

**ENR 1.2 THE VISUAL FLIGHT RULES**

**1. FLIGHT RULES**

**1.1 The Visual Flight Rules (VFR)**

1.1.1 VFR flight may only be conducted:

- a. in VMC;
- b. ADF - provided that, when not navigating by visual reference to the ground or water, the aircraft captain must comply with the requirements of IFR flight, as if the flight were an IFR flight;
- c. at sub-sonic speeds; and
- d. in accordance with the airspace speed limitations specified in *ENR 1.4*.

1.1.2 Unless the aircraft captain is authorised to conduct a flight under the IFR or at night under the VFR and the aircraft is appropriately equipped for flight at night or under the IFR, a VFR flight must not be conducted at night.

1.1.3 For pilots not authorised to fly at night, it is recommended that they plan to arrive at the later of the destination aerodrome or alternate aerodrome at least 10 minutes before last light (allowing for any required holding).

1.1.4 **ADF** - State aircraft using NVD/NVG within any airspace may operate at night in accordance with day VFR.

**1.2 Special VFR**

1.2.1 By day, when VMC do not exist, the ATC unit responsible for a CTR or CTA may issue, at pilot request, and provided an IFR flight will not be unduly delayed, a Special VFR clearance for flight:

- a. in the CTR; or
- b. in a CTA next to the CTR for the purpose of entering or leaving the CTR.

1.2.1.1 **ADF**- Military CTR/CTA/RA - By day or NVD/NVG, when VMC do not exist, the ATC unit responsible for a Military CTR/CTA/RA may issue, at pilot request, a Special VFR clearance for flight inside military Restricted Areas and in terminal area or control zone surrounding a military aerodrome.

*Note: At Darwin and Townsville, SVFR should not unduly delay civil IFR flight.*

1.2.2 When operating under a special VFR clearance, pilots are responsible for ensuring that:

- a. the flight is conducted clear of cloud;
- b. the visibility is not less than:
  - 1) for aeroplanes, 1,600M;
  - 2) for helicopters, 800M; or
  - 3) for balloons, 100M below 500FT AGL and 1,600M at and above 500FT AGL;
- c. a helicopter is operated at such a speed that the pilot has adequate opportunity to observe any obstructions or other traffic in sufficient time to avoid a collision; and

1.2.3 Special VFR is not permitted in Class E airspace.

## 2. VISUAL METEOROLOGICAL CONDITIONS (VMC) - TAKE-OFF, EN ROUTE AND LANDING

2.1 ADF - The cloud and visibility criteria for VMC, including specific additional requirements, are contained in the following table:

Item	Type of Aircraft	Class of Airspace	Height	Flight Visibility	Distance from Cloud	Operational Requirements
1.	Aircraft	A, B, C, E or G	At or above 10,000 ft AMSL	8,000 m	1,500 m horizontal 1,000 ft vertical	
2.	Aircraft	A, B, C, E or G	Below 10,000 ft AMSL	5,000 m	1,500 m horizontal 1,000 ft vertical	
2A.	Aircraft	C	Below 10,000 ft AMSL	5,000 m	Clear of cloud	Operations must comply with DASR SPA.55 NVIS
2B.	Aircraft	Any class	Below 10,000 ft AMSL	5 000 m or less, but not less than 3 000 m. In all cases, only with a relevant MAO approval		Operations must comply with DASR SPA.55 NVIS
3.	Aircraft	D	All heights	5,000 m	600 m horizontal 1 000 ft vertical above cloud 500 ft vertical below cloud	
4.	Aircraft	G	At or below whichever is the higher of: (a) 3 000 ft AMSL; (b) 1 000 ft AGL	5,000 m	Clear of cloud	Aircraft must be operated in sight of ground or water
5.	Rotorcraft	G	Below 700 ft over land. Below 700 ft over water <i>with</i> track guidance from a navigation system	800 m	Clear of cloud	Operations must comply with conditions stated in subsection 2.1.1
6.	Rotorcraft	G	Below 700 ft over water <i>without</i> track guidance from a navigation system	5,000 m	600 m horizontal and 500 ft vertical	Operations must comply with conditions stated in subsection 2.1.1

*Note 1: Subject to ATC clearance, operation under the special VFR may be available within a control zone.*

*Note 2: Refer to regulation 91.285 for restrictions on VFR flight in Class A airspace.*

2.1.1 ADF - For items 5 and 6 of the table above, the conditions are that the flight must be conducted:

- a. by day or NVIS; and
- b. at a speed that allows the pilot in command to see obstructions or other traffic in sufficient time to avoid a collision; and
- c. if not more than 10 NM from an aerodrome with an IAP - in a way that ensures the flight maintains a separation of at least 500 ft vertically from any aircraft that is:
  - 1) less than 10 NM from the aerodrome; and
  - 2) conducting an IFR operation.



## ENR 1.3 THE INSTRUMENT FLIGHT RULES

### 1. THE INSTRUMENT FLIGHT RULES (IFR)

1.1 **ADF** - The IFR must be used by flights conducted in circumstances other than those specified in FIHA ENR 1.2 [paragraph 1.1](#), unless otherwise specifically authorised.

1.2 IFR flights must be conducted in accordance with the airspace speed limitations specified in *ENR 1.4*.

### 2. FLIGHT RULES NOMINATION

2.1 The nomination of a flight as IFR or VFR determines:

- a. the flight notification requirements;
- b. separation requirements in Classes A, C and D airspace;
- c. separation requirements for aircraft in receipt of an airways clearance in Class E airspace; and
- d. traffic information requirements in classes E and G airspace.





**ENR 1.4 ATS AIRSPACE CLASSIFICATION**

**1. CONTROLLED AIRSPACE**

**1.1 General**

1.1.1 Controlled airspace is defined as “airspace of defined dimensions within which air traffic control services are provided to IFR flights and to VFR flights in accordance with the airspace classification”.

1.1.2 Controlled airspace is a generic term which, in Australia, covers ATS airspace Classes A, C, D & E.

1.1.3 Controlled airspace is established generally on the basis of the kinds of operations and considerations of flight procedures. Such airspace does not necessarily cover routes to alternate aerodromes.

1.1.4 Controlled airspace within the Brisbane and Melbourne FIRs is generally established as follows:

Class of Airspace	Application
Class A	<ul style="list-style-type: none"> <li>• within RADAR coverage - lower limit above FL180 and upper limit FL600;</li> <li>• outside RADAR coverage - lower limit FL245 and upper limit FL600; and</li> <li>• an area extending from 90NM south of Melbourne to Launceston and Hobart, lower limit FL180 and upper limit FL600.</li> </ul>
Class C	<ul style="list-style-type: none"> <li>• within RADAR coverage south of Sydney, lower limit FL125 and upper limit FL180 under Class A airspace;</li> <li>• in the control area steps associated with controlled aerodromes, excluding control area steps classified as Class D airspace; and</li> <li>• in control zones of defined dimensions.</li> </ul>
Class D	Control zones of defined dimensions, and associated control area steps, upper limit 4,500FT.
Class E	<ul style="list-style-type: none"> <li>• within RADAR coverage:                             <ul style="list-style-type: none"> <li>- south of Sydney, lower limit 8,500FT and upper limit FL125 under Class C airspace;</li> <li>- north of Sydney, lower limit 8,500FT and upper limit FL125;</li> </ul> </li> <li>• in the vicinity of Williamtown: coincident with the lateral limits of R578A-E above A045 - when R578 is not active;</li> <li>• continental Australia, lower limit FL125 and upper limit FL245 under Class A airspace;</li> <li>• in the control area steps associated with Class D controlled aerodromes excluding Class D or C airspace:                             <ul style="list-style-type: none"> <li>- Karratha Class E lower limit 5,500FT to upper limit FL125</li> <li>- Broome Class E lower limit 1,200FT AGL to upper limit FL125</li> <li>- Avalon Class E lower limit 700FT AGL to upper limit 4,500FT</li> </ul> </li> <li>• in the control area steps associated with Class C controlled aerodromes excluding Class C airspace:                             <ul style="list-style-type: none"> <li>- Perth Class E lower limit 8,500FT to upper limit FL125.</li> </ul> </li> </ul>

1.1.5 Operations in control areas and control zones must be conducted in accordance with the published procedures and requirements for that specific airspace and air traffic clearances. Special procedures may also be specified for an aerodrome within a control zone.

1.1.6 The extent of controlled airspace is promulgated in Aircservices Australia DAH, Aircservices Australia ERCA, Aircservices Australia VNC, Aircservices Australia VTC, Aircservices Australia SUP and NOTAM.

1.1.7 The hierarchy of airspace from most restrictive to least restrictive is as follows:

- a. Prohibited, Restricted or Military Operating Areas;
- b. Class A airspace;
- c. Class C airspace;
- d. Class D airspace;
- e. Class E airspace;
- f. Class G airspace.

1.1.7.1 When airspaces adjoin vertically (one above the other), flight at the common level must comply with the requirements of and will be provided the services applicable to, the less restrictive class of airspace.

1.1.7.2 Where a non-continuous airspace vertically adjoins controlled airspace (one above the other), the common level between airspaces becomes part of controlled airspace upon activation and is subject to an ATC clearance.

Airspace examples:

- a. When a Restricted Area or Class D control zone is not active, the common boundary at A045, between Class C and Class G airspace, is part of Class G airspace (the less restrictive airspace) and receives a Class G service (clearance not required):
- b. When a Restricted Area becomes active below Class C airspace, the common boundary at A045, between the Restricted Area and Class C airspace, becomes part of Class C airspace (the less restrictive airspace), and receives Class C services (clearance required):

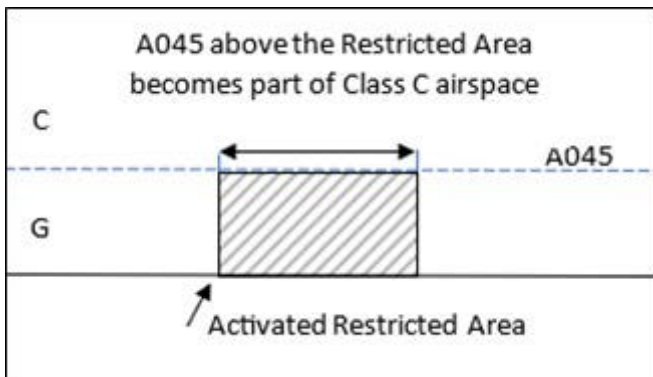
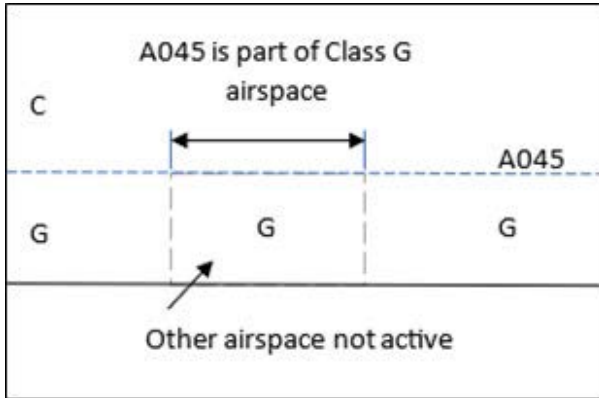

- c. When a Class D control zone becomes active below a Class C airspace, the common boundary at A045, between Class C and Class D airspace, becomes Class D airspace (the less restrictive airspace) with a Class D service (clearance required):

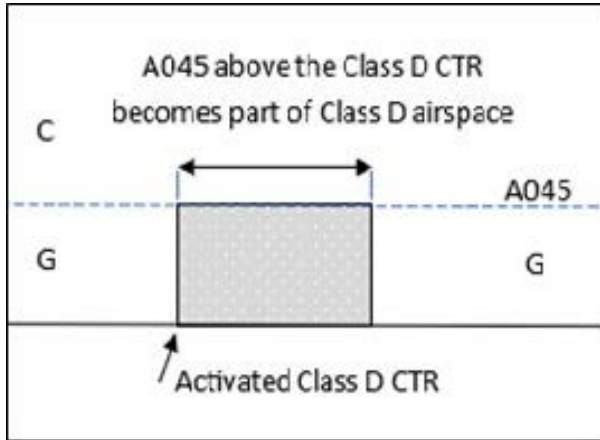

1.1.7.3 When airspaces adjoin laterally (one beside the other), flights at the common boundary must comply with, and will be provided the services applicable to, the less restrictive class of airspace.

1.1.7.4 Where a non-continuous airspace laterally adjoins controlled airspace, the common side boundary between airspaces becomes part of controlled airspace upon activation and is subject to ATC clearance.

Airspace example:

When a Restricted Area activates adjacent to a control area step, the common boundary between the Restricted Area and Class C airspace, becomes Class C airspace (the less restrictive airspace) with a Class C service (clearance required):

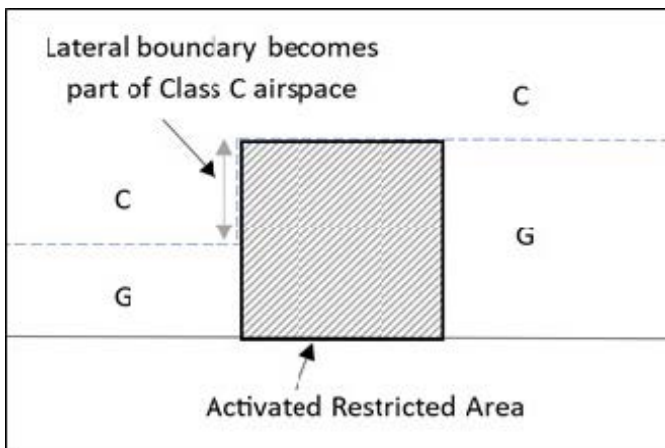

**1.2 Control Areas**

1.2.1 A CTA is defined as “a controlled airspace extending upwards from a specified limit above the earth.” CTA normally operate continuously. Areas identified by the word NOTAM may be activated, or additional areas may be established to meet temporary requirements, by the issuance of a NOTAM or Airservices Australia SUP.

**1.3 Control Zone**

1.3.1 A CTR is defined as “a controlled airspace extending upwards from the surface of the earth to a specified upper limit.” CTRs surround controlled aerodromes and are designated as follows:

- a. **Civil CTR:** A CTR administered by a civil air navigation service provider, other than a military CTR. Class C or Class D procedures and services apply.
- b. **Military CTR:** A CTR administered by the Australian Defence Force. Class C procedures and services apply to civil flights.

\* *ADF Note: Military flights may be subject to alternative procedures and services within a military CTR as detailed within the relevant FIHA AD2 SUPP.*

1.3.2 Control Zones are active during the hours of the operation of the control tower as published in ERSA or as varied by NOTAM.

*Note: Military CTRs may be activated at short notice. Pilots should plan their operations on the basis that CTRs are active unless advised to the contrary.*

**1.4 Airspace Reservation**

1.4.1 A designated airspace or portion thereof under the control of another authority may be reserved to allow the following:

- a. flights of special military significance requiring the use of controlled airspace, which would be subject to unacceptable restrictions if normal procedures applied;
- b. civil flights requiring passage through a military airspace when weather conditions or other factors make flight on the normal air route inadvisable, or impossible, and when other routes are unavailable, or the use of such routes would impose severe economic penalties on the operation of the aircraft.

1.4.2 There are two types of airspace reservations: fixed defined areas and “mobile” (e.g. aerial refuelling, en route formation flights, etc). Such reservations are normally only applied during limited periods. A designated airspace or portion thereof under the control of a Military ATC may also be reserved to confine particular activities. In such airspace, Military ATC is responsible for the separation of transiting civil or military aircraft from areas reserved or restricted for air defence operations.

1.4.3 Airspace reservations do not alter the underlying established airspace classification or the level of ATS. In controlled airspace or military airspace, the reservation provides assurance that ATC will accommodate the activity for the published duration.

**1.5 Authorisation of Civil Flights in Military Airspace**

1.5.1 Civil flights in military airspace may be authorised subject to military activity, weather and any special procedures for the control of civil aircraft which have been published.

1.5.2 Unless otherwise specified, civil aircraft operating in military airspace will receive the following level of service:

Airspace	Level of service for civil flight
Military airspace controlled/administered by Military ATC	Approved aircraft - equivalent to Class A and/or Class C airspace, as applicable
Restricted Areas and Military Operating Areas controlled/administered by other military units e.g. Navy or Army	No ATS <i>Note: ATC may provide limited FIS and SAR services in accordance with ENR 1.1 Section 2.2</i>
<i>Note: Military ATC areas are identified in DAH as controlled/administered by 452SQN or 453SQN. See ENR 1.1 paragraph 2.2.4</i>	

### 1.6 Release of Control Areas, Control Zones, Restricted or Military Operating Areas

1.6.1 The responsibility for a Control Area or Control Zone (civil or military), either wholly or in part, may be released to another ATS unit (civil or military). The airspace remains active and a clearance is required to enter.

1.6.2 The responsibility for a Restricted or Military Operating Area, either wholly or in part, may be transferred to an ATS unit. The released airspace remains active and a clearance or approval, as appropriate, is required to enter.

1.6.3 The service provided to aircraft within released airspace will be:

- a. for Restricted or Military Operating Areas - in accordance with the established airspace classification depicted on AIP MAP or in DAH (i.e. the airspace classification when the area is not active).
- b. For control areas or control zones - in accordance with the airspace classification for the airspace when it is active.

1.6.4 ATC will advise pilots of the level of service they will receive when granting approval or clearance to enter a released area from Class E or G airspace, or if the level of service will be in accordance with Class E or G within the released area.

### 1.7 Deactivation of Control Zones or Special Use Airspace

1.7.1 The published cessation time of a control zone or SUA may be amended:

- a. without issue of a NOTAM provided the new cessation time is within one hour prior to the original published cessation time, or
- b. with subsequent issue of a NOTAM when the deactivation is one hour or more prior to the original published cessation time.

1.7.2 Any amendments to the published cessation time of a control zone or SUA will be notified to affected pilots in accordance with *GEN 3.3 Section 3.3*.

1.7.3 Non-controlled aerodrome procedures apply to all military towered aerodromes when the CTR is deactivated.

## 2. PROVISION OF SEPARATION IN CONTROLLED AIRSPACE

### 2.1 General

2.1.1 In Class A airspace, IFR flights only are permitted. All flights are provided with an air traffic control service and are separated from each other.

2.1.2 In Class C airspace, IFR and VFR flights are permitted. All flights are provided with an air traffic control service and IFR flights are separated from other IFR, Special VFR, and VFR flights. VFR flights are separated from IFR flights and receive traffic information in respect of other VFR flights. Special VFR flights are separated from other Special VFR flights when visibility is less than VMC.

2.1.3 In Class D airspace, IFR and VFR flights are permitted and all flights are provided with an air traffic control service. IFR flights are separated from other IFR and Special VFR flights, and receive traffic information in respect of VFR flights. VFR flights receive traffic information in respect of all other flights. Special VFR flights are separated from other Special VFR flights when visibility is less than VMC.

2.1.4 In Class E airspace, IFR and VFR flights are permitted. IFR flights are provided with an air traffic control service, are separated from other IFR flights, and receive traffic information on VFR flights as far as is practicable. VFR flights receive a Surveillance Information Service (SIS) on request.

2.1.5 At controlled aerodromes, ATC provides runway separation to all aircraft.

2.1.6 ADF - In military controlled airspace, variations to air traffic services to military aircraft are detailed within the relevant FIHA AD2 SUPP.

## 2.2 Special Provisions

2.2.1 Notwithstanding the general provisions of [sub-section 2.1](#), the following also apply:

- a. The separation of aircraft taxiing on the manoeuvring area (which does not include apron and parking areas) is a joint pilot and controller responsibility. The pilot must maintain separation while complying with clearances and instructions.
- b. In the traffic circuit, pilots are required to position their aircraft in such a manner that, while complying with clearances and instructions from ATC, they maintain the necessary separation from other traffic.
- c. Separation is not normally provided within a training area in controlled airspace.
- d. Under certain conditions, the pilot of one aircraft may be given the responsibility for separation with other aircraft. In this circumstance:
  - 1) the pilot is also responsible for the provision of wake turbulence separation;
  - 2) the pilot must advise ATC when they are unable to maintain, or have lost, sight of the other aircraft;
  - 3) where an aircraft has been instructed to maintain own separation from an IFR aircraft, ATC will issue traffic information to the pilot of the IFR aircraft, including advice that responsibility for separation has been assigned to the other aircraft; and
  - 4) aircraft flying in formation will not be provided with separation with respect to other aircraft of the same formation, including for take off and landing.
  - 5) aircraft flying as part of an in-company flight will not be provided with separation with respect to other aircraft of the same in-company flight whilst airborne. Runway separation will continue to be provided.
- e. ATC will consider a formation of aircraft broken and will therefore process aircraft individually from the time the formation aircraft are:
  - 1) cleared to carry out touch-and-go landings;
  - 2) required to go-around; or
  - 3) cleared to carry out individual activities.

*Note: A group of civil aircraft conducting the same flight (e.g. an air safari), which require the aircraft to operate at separation distances greater than those specified for formation flights will be considered to be separate aircraft when applying separation.*

## 2.3 Wake Turbulence Separation

2.3.1 ATC is not required to apply wake turbulence separation in the following situations:

- a. when a MEDIUM fixed-wing aircraft of less than 25,000KG MTOW precedes a LIGHT aircraft;
- b. when an aircraft is landing behind another aircraft that is taking off on the same runway;
- c. subject to para 2.3.2, if a pilot has initiated a waiver of the relevant departure wake turbulence separation minimum;
- d. when a VFR aircraft is in flight and is:
  - 1) operating directly behind a preceding HEAVY or MEDIUM aircraft; or
  - 2) landing on the same runway as a preceding HEAVY or MEDIUM aircraft; or
  - 3) landing on a parallel runway separated by less than 760M from the runway of a preceding HEAVY or MEDIUM aircraft;
- e. when an IFR aircraft is in flight and the pilot has:
  - 1) reported the preceding aircraft in sight; and
  - 2) accepted responsibility to follow, or maintain their own separation with that aircraft.

*Note 1: For paragraphs (d) and (e), the pilot in command of the aircraft is responsible for ensuring that the spacing from a preceding aircraft of a heavier wake turbulence category is acceptable. If it is determined that additional spacing is required, the flight crew may inform ATC accordingly, stating their requirements.*

*Note 2: Super, Heavy or Medium Wake Turbulence category aircraft may be operating near the base or boundaries of controlled airspace. Aircraft operating in Class G airspace in the vicinity of controlled airspace may be affected by wake turbulence from aircraft operating within controlled airspace.*

**2.3.2 ADF - Pilot-initiated waiver of wake turbulence separation.** The pilot may ask ATC to waive the application of wake turbulence separation with a preceding aircraft. A pilot requesting the waiver must be keenly aware that this makes the requesting pilot responsible for avoiding or mitigating the effects of wake turbulence from preceding aircraft. When initiated by the pilot, Defence ATC may apply a wake turbulence waiver to the pilot of a military aircraft and other authorised aircraft:

- a. in any phase of flight
- b. by day or night
- c. in VMC or IMC, regardless of meteorological conditions
- d. regardless of the wake turbulence categories involved
- e. provided a wake turbulence caution is issued in accordance with MATS.

*ADF Note 1: Civil ATC will not waive wake turbulence separation if the preceding aircraft is a heavy or super wake turbulence category aircraft (e.g. Airbus A330 or larger).*

*Note 2: More information about wake turbulence can be found in Advisory Circular (AC) 91-16, available on the CASA website.*

**2.3.3 ADF - Rotary wing waivers.** In military administered airspace, airborne and runway wake turbulence separation standards are not required to be applied between military helicopters and other authorised helicopters, and a heavier preceding wake turbulence category aircraft on condition that:

- a. the preceding aircraft is not a fixed wing Heavy or Super wake turbulence category
- b. weather conditions permit the pilot to maintain continual observation of the preceding aircraft
- c. a 'wake turbulence caution' is issued to all Light helicopters following a Heavy wake turbulence helicopter.

**2.3.4 ADF - Authorised helicopters include RSAF CH-47, Toll B412 and AW139 operating to any location, and CHC AW139 operating at HMAS Albatross.**

## 2.4 ADF - Military CTA

2.4.1 Separation of visual traffic in an Aerodrome Traffic Zone is a joint pilot and controller responsibility.

2.4.2 Air traffic controllers shall issue clearances designed to maintain separation and shall provide a traffic information and alerting service. Pilots shall be required to position their aircraft in a manner which complies with clearances and instructions from ATC.

## 2.5 ADF - Military Training Areas

2.5.1 Approved variations to separation standards, which can only be applied in military controlled/restricted airspace, shall be promulgated in the relevant FIHA AD2 Supp.

*Note: For the purposes of the above paragraph, CFOO is the authorised delegate for operations within Oakey Military Airspace.*

2.5.2 The commander of a military base may vary the separation standards applied in those areas for which the base is responsible, for specific operations of visiting military aircraft. The variation to separation standards may only be to the extent already employed at the home base of the affected aircraft.

2.5.3 Variations to separation standards shall not apply to aircraft carrying VIP, civil IFR aircraft, transiting military IFR aircraft and aircraft departing using SID/SRD procedures.

2.5.4 When a RADAR service is not available and a separation service is required, it should be provided within military controlled/restricted airspace as follows:

- a. **Lateral Separation.** Apply lateral separation by dividing airspace into sectors. The sectors should accommodate the aircraft type expected to operate therein, ensuring that lateral separation exists with adjacent sectors and air routes. MSA shall be published.
- b. **Vertical Separation.** Apply vertical separation by dividing airspace/sectors into height blocks. The height blocks should accommodate the aircraft type expected to operate therein, ensuring that vertical separation exists with adjacent height blocks. MSA shall be published.

When a RADAR service is not available, separation is not normally applied in VMC within military controlled/restricted airspace between:

- a. military aircraft, and
- b. military aircraft and civil VFR aircraft.

## 2.6 ADF - Pilot responsibility for separation (PRS).

2.6.1 PRS permits improved operational flexibility within airspace under military control, including military operating areas, at any level during all phases of flight. Active PRS aircraft maintain separation with one or more Passive aircraft through utilising on-board surveillance systems or pilot visual sighting. The procedure must only be conducted between ADF aircraft and approved aircraft.

2.6.2 The following aircraft are approved for Active PRS:

- a. F18 (all types)
- b. F35
- c. Hawk - visual separation only
- d. PC-21 - visual separation only
- e. Raytheon Australia Lear Jet - visual separation only
- f. approved aircraft - as per letter of agreement or exercise instructions.

2.6.3 The following aircraft are approved for Passive PRS:

- a. all ADF aircraft
- b. Air Affairs Australia aircraft
- c. RSAF PC-21
- d. foreign military aircraft.

2.6.4 PRS may be conducted under the following conditions:

- a. The pilot of the Active PRS aircraft accepts a contract from ATC to maintain PRS with identified Passive PRS aircraft.
- b. ATC should advise the Passive PRS aircraft of the other aircraft pilot's responsibility to maintain separation.

2.6.5 The pilot conducting Active PRS is responsible to maintain surveillance system or visual contact and separation with the assigned Passive PRS aircraft until either:

- a. ATC establish another separation standard and cancel PRS
- b. PRS participants exit military controlled airspace and enter non-controlled airspace.

2.6.6 ATC responsibilities during the conduct of PRS include:

- a. when practicable and relevant, advise the passive PRS aircraft about the active PRS aircraft
- b. where required and workload permitting, issue a wake turbulence caution.

2.6.7 The following radio telephony shall be used for the initiation of PRS by:

- a. ATC:
  - 1) (ATC) - (Callsign), TRAFFIC (callsign), [TYPE], (position) [SQUAWKING (code)], REPORT CONTACT/TRAFFIC SIGHTED (as appropriate)
  - 2) (Pilot) - (Callsign), CONTACT/SIGHTED
  - 3) (ATC) - (Callsign), MAINTAIN PRS (callsign), [other control instructions]
- b. Pilot:
  - 1) (Pilot) - (Callsign), REQUEST PRS (Callsign if known, type/position (as relevant)
  - 2) (ATC) - (Callsign), MAINTAIN PRS (passive PRS Callsign) [other control instructions]

## 3. CLASS G AIRSPACE

### 3.1 Flight Information Areas

3.1.1 Non-controlled airspace in the Brisbane FIR and Melbourne FIR is classified as Class G airspace.

3.1.2 North of 65° South, Class G airspace is divided into designated Flight Information Areas (FIA) within which a Flight Information Service (FIS) and SAR alerting services are provided by an ATS unit.

3.1.3 On and north of 65° South, in Class G airspace, IFR and VFR flights are permitted. IFR flights receive traffic information and a flight information service. VFR flights receive a flight information service and may receive a surveillance information service if requested (ATC workload permitting).

3.1.4 South of 65° South, in Class G airspace, IFR and VFR flights are permitted and all flights receive a flight information service on request.



**3.2 Broadcast Areas**

3.2.1 Broadcast Areas are defined airspace volumes that form part of a Flight Information Area and have a discrete frequency (CTAF).

*Note: The conditions described at paragraphs 3.1.2 and 3.1.3 apply.*

3.2.2 The vertical boundaries of a Broadcast Area are:

- a. Surface to 5,000FT AMSL (default); or
- b. Surface to the base of CTA if 8,500FT or less; or
- c. Surface to a nominated level.

3.2.3 The lateral and vertical boundaries are defined in AIP DAH.

3.2.4 Broadcast Areas may be subject to mandatory broadcast requirements; these requirements are defined in the ERSA.

**4. CLASSES OF AIRSPACE - SERVICES AND REQUIREMENTS**

4.1 The following table summarizes the services and requirements for the various classes of airspace used in Australian FIRs.

Class	Type of Flight	Separation Provided	Service Provided	Airspace Speed Limitation	Radio COM Requirements	ATC Clearance
<b>A</b>	IFR	All aircraft	ATC service	N/A	Continuous two-way	Yes
	VFR	VFR not permitted (Note 4)				
<b>C</b>	IFR	IFR from IFR IFR from VFR IFR from Special VFR	ATC service	N/A	Continuous two-way	Yes
	VFR	VFR from IFR	1. ATC service for separation from IFR  2. VFR/VFR traffic information (and traffic avoidance advice on request)	250KT IAS below 10,000FT AMSL (Note 1)	Continuous two-way	Yes
	Special VFR	Special VFR from Special VFR, when visibility does not meet VMC	ATC service		Continuous two-way	Yes
<b>D</b>	IFR	IFR from IFR IFR from Special VFR	ATC service, traffic information about VFR flights	200KT IAS at or below 2,500FT AAL within 4NM of the primary Class D aerodrome (Note 2)	Continuous two-way	Yes
	VFR	Nil	ATC service, traffic information on all other flights.		Continuous two-way	Yes
	Special VFR	Special VFR from Special VFR when visibility is less than VMC	ATC service	250KT IAS - in the remaining Class D airspace (Note 1)	Continuous two-way	Yes

Class	Type of Flight	Separation Provided	Service Provided	Airspace Speed Limitation	Radio COM Requirements	ATC Clearance
<b>E</b>	IFR	IFR from IFR	ATC service and traffic information on VFR flights as far as is practicable	250KT IAS below 10,000FT AMSL (Note 1)	Continuous two-way	Yes
	VFR	Nil	FIS SIS - flight following on request, (ATC workload permitting)	250KT IAS below 10,000FT AMSL (Note 1)	Continuous two-way	No
<b>G</b> On & North of 65° South	IFR	Nil	FIS	250KT IAS below 10,000FT AMSL (Note 1)	Continuous two-way	No
	VFR	Nil	FIS SIS - flight following on request, (ATC workload permitting)	250KT IAS below 10,000FT AMSL (Note 1)	VHF radio required for operations above 5,000FT AMSL and at aerodromes where carriage and use of radio is required	No
				250KT IAS below 10,000FT AMSL (Note 1)	VHF radio required for operations in reduced VMC	No
<b>G</b> South of 65° South	IFR	Nil	FIS on request	250KT IAS below 10,000FT AMSL (Note 1)	Continuous two-way	No
	VFR	Nil	FIS on request	250KT IAS below 10,000FT AMSL (Note 1)	Nil	No
<p><i>Note 1: ADF - Airspace speed limitations, dependant on class of airspace, are not applicable to military aircraft, except as specified in ERSA. In military controlled airspace, Airspace Speed Limitations are not applicable to authorised operators.</i></p> <p><i>Note 2: ADF - If traffic conditions permit, ATC may approve a pilot's request to exceed the 200KT speed limit to a maximum limit of 250KT unless the pilot informs ATC a higher minimum speed is required. In military controlled airspace, Class D Airspace Speed Limitations are not applicable to authorised operators.</i></p> <p><i>Note 3: ADF - VMC minima are detailed in ENR 1.2.2.</i></p> <p><i>Note 4: ADF - The exclusion of VFR flight from Class A airspace does not apply to military aircraft, nor to approved aircraft in military controlled Class A airspace or military operating areas.</i></p>						

4.2 Separation is not provided between aircraft within controlled airspace and any aircraft in close proximity but remaining outside controlled airspace.

*Note: Aircraft within controlled airspace or SUA may be operating up to the lateral boundary of the airspace.*

### 5. LANES OF ENTRY (LOE)

5.1 Lanes of entry are established to permit passage to and from specified Class D CTR without entering an adjacent civil or military controlled airspace. The vertical limits of the LOE provide separation from overlying control areas and military airspace.

5.1.1 When using these lanes, pilots must:

- a. operate under the VFR;
- b. conform with the general flight rules regarding terrain clearance, flight over populous areas, and low level restricted areas;
- c. operate not higher than the altitude specified as the upper limit in the section being flown; and
- d. keep to the right.

### 6. REGULATION OF FLIGHT - ASSESSMENT OF PRIORITIES

6.1 Subject to the duty to facilitate and maintain the safe, orderly and expeditious flow of air traffic, ATC will apply priorities in the following order:

- a. An aircraft in an emergency, including being subjected to unlawful interference, will be given priority in all circumstances.
- b. A multi-engine aircraft which has suffered the loss of an engine and has not been subject to a SAR phase, or has not been considered under the provision of sub-paragraph a. above, shall be granted priority for landing.
- c. An aircraft which has suffered radio communications failure will be granted priority for landing.
- d. An aircraft participating in a Search and Rescue (SAR), Medical (MEDEVAC), or Fire and Flood Relief (FFR) flights shall be granted priority as necessary.
- e. An aircraft operating under police call sign "POLAIR RED" or "FEDPOL RED" engaged in operations where life is at risk.
- f. An aircraft engaged in the personal transport of Heads of State or of Government, or other selected dignitaries on official visits to Australia, or the personal transport of the Governor-General or the Prime Minister.
- g. State aircraft special requirements flights where clearance has been prearranged.
- h. Aircraft directed by Defence to participate in significant aerial displays.

6.2 Subject to the priorities of para 10.1, an aircraft first able to use the manoeuvring area or desired airspace in the normal course of its operations will be given priority except:

- a. an aircraft landing or taking off will be given priority over taxiing aircraft;
- b. a landing aircraft will have priority over a departing aircraft if the latter cannot take off with prescribed separation standards;
- c. for flights in Class C terminal control areas associated with Brisbane, Melbourne, Perth and Sydney, ATC will apply priorities in the following order;
  - 1) with equal priority, flights compliant with their ATFM requirements, flights exempt from ATFM measures and Medical Aircraft (HOSP) operations; and
  - 2) flights not compliant with their ATFM requirements;
  - 3) all other aircraft.

*Note: Further information about ATFM procedures at Australian airports is available at ENR 1.9.*

- d. for flights in other Class C terminal control areas, ATC will apply priorities in the following order:
  - 1) with equal priority, flights with a Calculated Off Blocks Time (COBT), scheduled air transport operations, State aircraft (other than training flights) and Medical Aircraft (HOSP) operations; and
  - 2) all other aircraft
- e. RVSM-approved aircraft will be given priority for level requests between FL290 and FL410 inclusive over aircraft not RVSM-approved;

- f. within ATS surveillance system coverage, identified aircraft may be given priority over non-identified aircraft;
- g. inside military airspace surrounding a military aerodrome, priorities will be determined by the controlling or administrating authority published in DAH. Military aerodromes do not include Darwin or Townsville;
- h. for training flights;
  - 1) training flights operating in the traffic pattern in general use will be given priority over other training flights desiring to operate in conflicting patterns for training purposes; and
  - 2) when a training instrument approach is approved, priority will be given to that aircraft from the time it commences its final approach until the approach is completed.

## ENR 1.5 HOLDING, APPROACH AND DEPARTURE PROCEDURES

### 1. HOLDING AND APPROACH TO LAND PROCEDURES

#### 1.1 General

1.1.1 Unless otherwise specified, the provisions of this section apply to aircraft operating under the IFR.

1.1.2 The arrival, holding, approach and departure procedures are developed in accordance with the criteria contained in *ICAO DOC 8168: Procedures for Air Navigation Services – Operations (PANS-OPS)*, *ICAO DOC 9905: Required Navigation Performance Authorization Required (RNP AR) Procedure Design Manual*, and the *Part 173 MOS* and other design criteria as approved by CASA under *CASR Part 173*.

#### 1.2 Aircraft Performance Category.

1.2.1 The following categories, based upon  $V_{at}$  (except for CAT H) determine landing minima for aircraft:

<b>CAT:</b>	<b>A</b>	speeds up to 90KT IAS.
	<b>B</b>	speeds from 91KT to 120KT IAS.
	<b>C</b>	speeds from 121KT to 140KT IAS.
	<b>D</b>	speeds from 141KT to 165KT IAS.
	<b>E</b>	speeds from 166KT to 210KT IAS.
	<b>H</b>	(helicopters) see <a href="#">sub-section 1.3</a> .

*Note:*  $V_{at}$  is the indicated airspeed at the threshold which is equal to the stalling speed  $V_{so}$  multiplied by 1.3 or the stalling speed  $V_{s1g}$  multiplied by 1.23. Both  $V_{so}$  and  $V_{s1g}$  apply to aircraft in the landing configuration at the maximum certificated landing weight. If both  $V_{so}$  and  $V_{s1g}$  are available for an aircraft, the higher resulting  $V_{at}$  must be used.

1.2.2 An aircraft must fit into and be operated in accordance with the requirements of only one category. An aircraft:

- may not reduce category because of reduced operating weight, but
- must increase category when actual handling speeds are in excess of those for category (based on  $V_{at}$ ) detailed at [sub-section 1.17](#).

1.2.3 **ADF** - Provided an aircraft can operate within the limits of the handling speeds (detailed at sub-section 1.17) for a lower category than the category determine by  $V_{at}$ , and subject to MAO approval, ADF aircraft may operate at the lower category.

#### 1.3 Helicopters

1.3.1 The following criteria apply to helicopter-specific instrument approach procedures and operations:

- the stall speed method of calculating aircraft category does not apply to helicopters;
- where helicopters are operated similarly to aeroplanes, they may be classified as CAT A;
- procedures developed for the specific use of helicopters are:
  - designated "CAT H", and
  - promulgated on separate charts; i.e., they are not included on charts containing procedures for other aircraft categories.

#### 1.4 Minimum Route Altitudes

1.4.1 Except when complying with the requirements for a visual approach, when conforming to a published DME or GNSS Arrival Procedure, or when identified and assigned an altitude by ATC, an aircraft approaching an aerodrome must not descend below the LSALT or the MSA for the route segment being flown (see [paragraph 2.3](#)) until it has arrived over the IAF or facility.

*Note 1: ADF - RADAR Terrain Clearance charts (RTCC) depict RADAR control charts; distances and bearings are measured from the RADAR head unless otherwise stated. These charts are not based on aircraft interpreted nav aids and are only to be used for monitoring ATC altitude assignments. The altitudes are calculated to provide a minimum of 1000FT and 3NM clearance from all known obstacles.*

*Note 2: ADF - Design criteria for RTCC and MSA minima calculations are different. As such, minimum altitudes may appear to be contradictory, however each is correct for the applicable procedure.*

### 1.5 Procedure Entry

1.5.1 Having arrived over the IAF or facility, and except as provided for in [paragraph 2.5](#), further descent must be made in accordance with the entry and holding procedures to the specified altitude for commencing the approach and, subsequently, in accordance with the approved instrument approach procedure.

#### 1.6 Circling Approaches and Visual Circling

1.6.1 A circling approach is an instrument approach to the circling minima with the intent or requirement from the minima to visually manoeuvre the aircraft to align with the runway for a landing. Each circling situation is different because of variables such as runway layout, final approach track, wind velocity and meteorological conditions. Therefore, there can be no single procedure designed that will cater for the conduct of a circling approach in every situation.

##### 1.6.2 Restrictions on Visual Circling:

- a. Where a prominent obstacle or obstacles within the circling area prevent visual circling the sector in which the obstacles are located may be eliminated from the visual circling area. Sectors which have been eliminated from the visual circling area are annotated "No Circling".
- b. Visual circling is prohibited in 'no circling' sectors by day in less than VMC and at night.

1.6.3 After initial visual contact, the basic assumption is that the runway environment (i.e. the runway threshold or approach lighting aids or other markings identifiable with the runway) will be kept in sight while at the MDA for circling (Reference: ICAO Doc 8168).

1.6.4 The visual circling procedure conducted at or above the circling MDA will provide protection from obstacles within the circling area (see Note 1 (3) and Note 3).

1.6.5 The information provided by spot heights on IAL charts must be treated with caution. Spot heights on IAL charts do not necessarily indicate the highest terrain, or all obstacles in the circling area. In addition, the charts may not cover all of the circling area. Before commencing an instrument approach, pilots should familiarise themselves with the location and altitude of obstacles in the circling area by studying an appropriate topographic map.

1.6.6 During visual circling, descent below the circling MDA may only occur when the pilot:

- a. maintains the aircraft within the circling area; and
- b. maintains a visibility, along the intended flight path, not less than the minimum specified on the chart for the procedure; and
- c. maintains visual contact with the landing runway environment (i.e. the runway threshold or approach lighting or other markings identifiable with the runway); and either
- d. by night or day, while complying with a., b. and c. and from a position within the circling area on the downwind, base or final leg of the landing traffic pattern at an altitude not less than the MDA, can complete a continuous descent to the landing threshold using rates of descent and flight manoeuvres which are normal for the aircraft type and, during this descent, maintains an obstacle clearance along the flight path not less than the minimum for the aircraft performance category until the aircraft is aligned with the landing runway; or
- e. in daylight only, while complying with a., b. and c., maintains visual contact with obstacles along the intended flight path and an obstacle clearance not less than the minimum for the aircraft performance category until the aircraft is aligned with the landing runway.

*Note 1: The concept is as follows:*

- 1) The pilot maintains visual contact with the landing runway while the aircraft is circled at MDA to a position within the traffic pattern that intercepts a normal downwind, base or final approach. If the MDA is above the downwind height, the pilot maintains MDA and downwind spacing until they reach a position from which descent at normal approach rates to join base can be made (see [Figure 1.2](#)).
- 2) When daylight exists and obstacles can be seen, the pilot has the option of descending from MDA from any position within the circling area while maintaining an obstacle clearance not less than that required for the aircraft performance category.
- 3) Once the pilot initiates descent below circling MDA, the obstacle protection offered by visual circling at the MDA ends and they are responsible for ensuring the required clearance from obstacles is maintained visually.

*Note 2: The pilot should maintain the maximum practical obstacle clearance. The minimum obstacle clearance requirements are:*

Categories A and B	300FT
Categories C and D	400FT
Category E	500FT.

*Note 3: The circling area is determined by drawing an arc centred on the threshold of each usable runway and joining these arcs by tangents. The radii are 1.68NM for Category A, 2.66NM for Category B, 4.20NM for Category C, 5.28NM for Category D, and 6.94NM for Category E. Runways less than 1,000M long are not considered usable for Categories C, D, and E.*

1.68NM	= 3,111M
2.66NM	= 4,926M
4.20NM	= 7,778M
5.28NM	= 9,779M
6.94NM	= 12,853M

### 1.7 Visual Manoeuvring (non-circling) Subsequent to Non-precision Approaches (NPA) and Approaches with Vertical Guidance (APV)

1.7.1 Straight-in NPA and APV do not normally require visual circling. In those circumstances where the NPA or APV does not serve the landing runway, the provisions of sub-section 1.6 apply.

1.7.2 **Descent below the Straight-in MDA.** Descent below the straight-in MDA or continuation of the approach below the DA during an APV, may only occur when:

- visual reference can be maintained;
- all elements of the meteorological minima are equal to or greater than those published for the aircraft performance category (see ENR 1.5 paragraph 5.1.1); and
- the aircraft is continuously in a position from which a descent to a landing on the intended runway can be made at a normal rate of descent using normal flight manoeuvres that will allow touchdown to occur within the touchdown zone of the runway of intended landing.

1.7.3 **NPA and APV Alignment.** An APV is aligned with the runway centreline. Straight-in NPA may be aligned with the runway centreline or may be offset by up to 15° (Category C & D) or 30° (Category A & B) (see paragraph 1.7.4 Note 1).

1.7.4 **Alignment with the Runway Centreline.** Manoeuvring to align the aircraft with the runway centreline can be undertaken when:

- within the circling area;
- visual reference can be maintained; and
- continuously in sight of ground or water.

*Note 1: Procedures with offset angles greater than 5° are designed such that aircraft cross the runway centreline no closer than 1,400M to the threshold. For offset angles equal to or less than 5°, the final approach track is designed to be within 150 metres of the runway centreline at 1,400M. Some older procedures may use 900M in place of 1,400M.*

*Note 2: For the purpose of this section “visual reference” means the runway threshold, or approach lights or other markings identifiable with the landing runway clearly visible to the pilot and a flight visibility not less than that specified for the procedure.*

### 1.8 Visual Approach Area - Helicopter

1.8.1 Helicopter GNSS instrument approach procedures may include a Visual Approach Area–Helicopter (VAA–H). These procedures are annotated in the minima box with the term ‘VAA’. The VAA-H extends from the Missed Approach Waypoint (MAWP) to the Helicopter Landing Site (HLS). Obstacle clearance at MDA is assured within a VAA–H.

1.8.2 The VAA - H comprises a 1NM wide corridor centred on the track from the MAWP to the HLS, plus the area beyond the HLS contained within a 0.5NM radius centred on the HLS.

Figure 1.1: Visual Approach Area - Helicopter

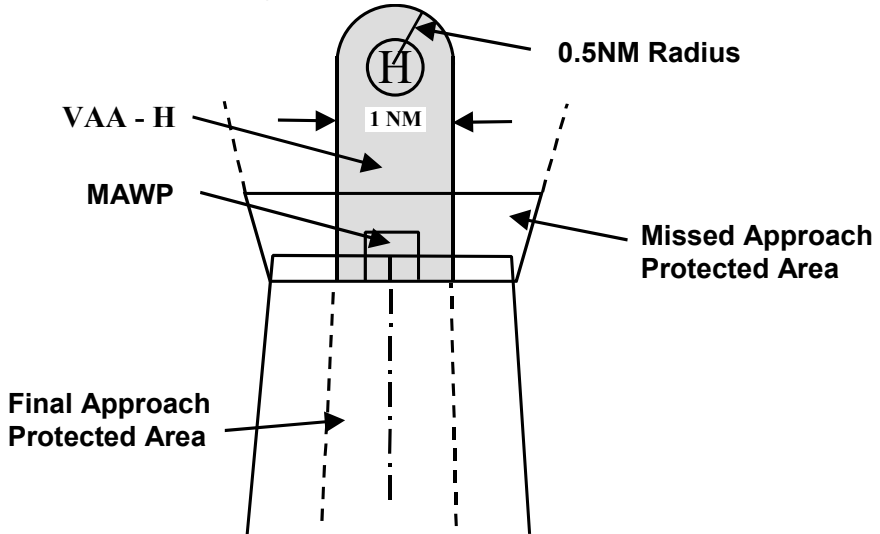

1.8.3 Flight within a VAA - H is a visual flight manoeuvre. After visual contact is established, and after passing the MAWP, the helicopter is manoeuvred within the VAA - H, at an altitude not below the MDA, utilising key lead-in points until the HLS is sighted.

1.8.4 Descent below MDA may only occur when the pilot:

- a. maintains the helicopter within the VAA - H; and
- b. maintains visibility along the intended flight path:
  - 1) by day, not less than that specified for helicopter VMC, and
  - 2) at night, not less than the published minimum visibility for the procedure; and
- c. maintains visual contact with key lead-in points (i.e., lighting or other prominent identifiable features) or the HLS; and
- d. while complying with a, b., and c., intercepts a normal approach path to the HLS for the particular helicopter and a landing is assured.



Figure 1.2: Visual Circling at Night

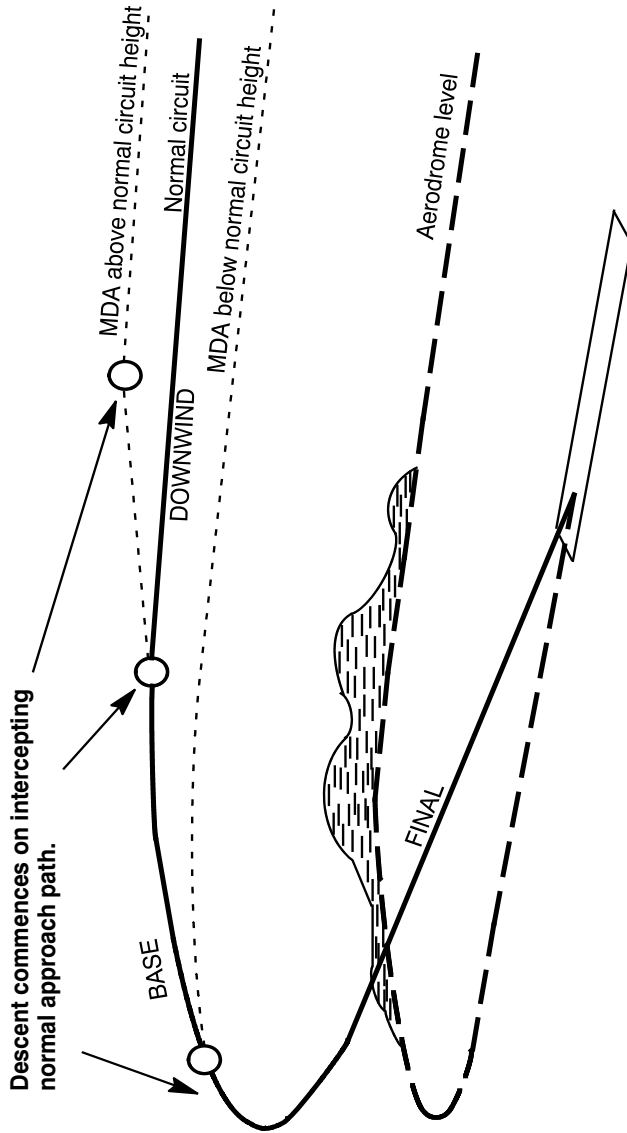

### 1.9 Missed Approach - Standard Procedures

1.9.1 A missed approach must be executed if:

- a. during the final segment of an instrument approach, the aircraft is not maintained within the applicable navigation tolerance for the aid in use; or
- b. during an instrument approach and below MSA (as specified on the IAL chart) the performance of the radio aid becomes suspect, or the radio aid fails; or
- c. visual reference is not established at or before reaching the MAPT or DA/RA Height from which the missed approach procedure commences; or
- d. a landing cannot be effected from a runway approach, unless a circling approach can be conducted in weather conditions equal to or better than those specified for circling; or
- e. visual reference is lost while circling to land from an instrument approach.

*Note 1: For the purpose of this paragraph "visual reference" means the runway threshold, or approach lights or other markings identifiable with the landing runway clearly visible to the pilot, and either:*

- a. *for circling approaches, clear of cloud, in sight of the ground or water and with a flight visibility not less than the minimum specified for circling; or*
- b. *for runway approaches, a flight visibility not less than that specified for the procedure.*

*Note 2: In IAL procedures, the missed approach is designed to provide a minimum obstacle clearance of 100FT to an aircraft climbing along the specified missed approach path at a gradient of 2.5% (152FT/NM) from the MAPT or DA/RA Height from which the missed approach procedure commences. If this missed approach climb gradient cannot be achieved the DA, MDA or RA Height should be increased, or other action taken to achieve the required obstacle clearance along the specified missed approach flight path.*

1.9.2 In executing a missed approach, pilots must follow the missed approach procedure specified for the instrument approach flown. In the event that a missed approach is initiated prior to arriving at the MAPT, pilots must fly the aircraft to the MAPT and then follow the missed approach procedure. The MAPT in a procedure may be:

- a. the point of intersection of an electronic glide path with the applicable DA; or
- b. a navigation facility; or
- c. a fix; or
- d. a specified distance from the Final Approach Fix (FAF).

1.9.3 When a missed approach is required from visual circling, the expectation is that the pilot will make an initial climbing turn toward the landing runway and overhead the aerodrome where the pilot will establish the aircraft climbing on the missed approach track. In as much as the circling manoeuvre may be accomplished in more than one direction, different patterns will be required to establish the aircraft on the prescribed missed approach course depending on its position at the time visual reference is lost.

### 1.10 Missed Approach Tracking

1.10.1 A missed approach procedure may, or may not, specify lateral guidance. In either situation the expectations of the pilot will vary as follows depending whether the procedure is based on a radio navaid or GNSS:

- a. When lateral guidance is specified with reference to a radio navaid (i.e. a VOR radial, an NDB bearing) the expectation is that the pilot will intercept the nominated track. Where an intercept is required it will be both stated in the missed approach procedure's text and shown in the plan view on the procedure plate. The text will take the form of: "At the NDB (or VOR), Turn Left (or Right) to intercept xxx° (navaid name) NDB (or VOR). Climb to (level)".
- b. When lateral guidance is specified based on GNSS the expectation of the pilot will take one of two forms:
  - 1) For a straight missed approach or a turn at the MAPt, the pilot is expected to follow the GNSS navigation commands to the next waypoint. The text will take the form of: "Turn Left (or Right), Track DCT (next waypoint). Climb to (level)".
  - 2) For a turn after the MAPt where there is not a subsequent waypoint the pilot is expected to make-good the nominated track on the chart using the GNSS for navigation. The text will take the form of: "Turn Left (or Right), Track xxx°. Climb to (level)".

- c. When the instrument procedure is based on a radio navaid but the missed approach does not specify lateral guidance the expectation is that the pilot will use DR to achieve the nominated track. Allowance for wind must be made to make-good this nominated track. The radio navaid may be used to supplement track keeping during the missed approach when it is a straight continuation of the final track, however guidance is not mandatory. The missed approach procedure's text will take the form of: "Turn Left (or Right), Track xxx°. Climb to (level)".

**1.11 Missed Approach Requirements - GNSS**

1.11.1 If a loss of RAIM or RAIM warning is indicated at any time after passing the Initial Approach Fix, the pilot must immediately carry out a missed approach in accordance with published procedures.

1.11.2 Provided the RAIM warning ceases when the missed approach is selected on the GNSS equipment, it may be used for missed approach guidance.

1.11.3 Should the RAIM warning remain when the missed approach is selected, or should there be any doubt about the accuracy of the GNSS, then an alternative means of guidance or dead reckoning must be used to fly the missed approach.

**1.12 Missed Approach - Helicopter Procedures**

1.12.1 Pilots flying a helicopter instrument approach procedure, or flying visually within a VAA- H, must execute a missed approach if:

- a. during the instrument approach and below MSA (as specified on the IAL chart) the performance of the navigation aid becomes suspect, or the navigation aid fails; or
- b. visual reference is not established at or before reaching the MAWP from which the published missed approach procedure commences; or
- c. visual reference is lost within the VAA - H; or
- d. a landing at the HLS is not assured.

*Note 1: For the purpose of this paragraph "visual reference" means:*

- a. the key lead-in points or HLS are clearly visible to the pilot; and
- b. clear of cloud, in sight of ground or water and with a flight visibility:
  - (1) by day, not less than that specified for Helicopter VMC, and
  - (2) by night, not less than the published minimum visibility for the procedure.

*Note 2: The missed approach is designed to provide a minimum obstacle clearance of 100FT to a helicopter climbing at a gradient of 4.2% (255FT/NM) from the MDA at, or before, the MAWP or from any point within the VAA-H, to the Missed Approach Turning Waypoint (MATWP) or Missed Approach Holding Waypoint (MAHWP), as applicable. If this missed approach climb gradient cannot be achieved, the MDA should be increased, or other action taken, to achieve the required obstacle clearance along the missed approach flight path.*

1.12.2 If executing a missed approach from the VAA - H of a helicopter GNSS approach, pilots must immediately track towards the MATWP or the MAHWP, as required by the particular procedure.

**1.13 Visual Segments**

1.13.1 When an instrument approach procedure specifies a visual segment from the point where the MDA is reached to the circling area of the aerodrome, a missed approach shall be executed unless the visual segment can be flown clear of cloud and in sight of the ground or water in accordance with the altitude and visibility specified for circling.

**1.14 Visual Approach Requirements for IFR flights**

1.14.1 ADF - The requirements of this section are the visual approach procedures applicable to IFR flights.

1.14.2 A pilot conducting a visual approach in controlled airspace may be assigned the responsibility to follow another arriving aircraft which they have reported sighting. When assigned this responsibility, the pilot must maintain separation from and not overtake that aircraft. In this circumstance, the pilot is also responsible for providing their own wake turbulence separation. If sighting is subsequently lost, advise ATC immediately.

## D

1.14.3 A pilot who is unable to continue a visual approach which has been authorised by ATC must immediately advise ATC.

1.14.4 When conducting a visual approach in controlled airspace, a pilot in command must not climb above an altitude reported to ATC as having been reached or left, unless authorised to do so.

## D

### 1.15 Visual approach requirements for IFR flights

1.15.1 The requirements of this section are the visual approach procedures applicable to IFR flights under *CASR 91.305(3)(b)(i)*.

1.15.2 A pilot in command operating under the IFR in controlled airspace must be satisfied that the visual approach requirements of *para 1.15.3* can be met before requesting a visual approach from ATC. The pilot must report 'VISUAL' to signify that these requirements can be met and maintained as part of any request to ATC for a visual approach.

1.15.3 Subject to the requirements of *paras 1.6, 1.9 and 1.13*, the pilot need not commence or may discontinue the approved instrument approach procedure to that aerodrome when:

- a. **By Day.** Within 30NM of that aerodrome at an altitude not below the LSALT/MSA for the route segment, the appropriate step of the DME or GNSS Arrival Procedure, or the MDA for the procedure being flown, the aircraft is established;
  - 1) clear of cloud;
  - 2) in sight of ground or water;
  - 3) with a flight visibility not less than 5,000M or, in the case of a helicopter, is able to proceed under helicopter VMC, or the aerodrome is in sight; and
  - 4) subsequently can maintain (1), (2) and (3) at an altitude not less than
    - i if in controlled airspace – 500FT above the lower limit of the CTA unless a clearance is received from ATC to depart and re-enter controlled airspace during the descent; and
    - ii (ii) the minimum height prescribed by CASR 91.265 or 91.267 as relevant to the location of the aircraft.
- b. **By Night.** At an altitude not below the LSALT/MSA for the route segment, the appropriate step of the DME or GNSS Arrival Procedure, or the MDA for the procedure being flown, the aircraft is established:
  - 1) clear of cloud;
  - 2) in sight of ground or water;
  - 3) with a flight visibility not less than 5,000M; and
  - 4) subsequently can maintain (1), (2) and (3) at an altitude not less than:
    - i in controlled airspace – 500FT above the lower limit of the CTA unless a clearance is received from ATC to depart and re-enter controlled airspace during descent; and
    - ii one of the following:
      - route segment LSALT/MSA; or
      - the appropriate step of the DME/GNSS Arrival Procedure; or
      - if being vectored – the last assigned altitude;
  - 5) until the aircraft is:
    - for an aerodrome with an authorised instrument approach procedure that the flight crew members of the aircraft are capable of using – within the prescribed circling area for the category of aircraft or a higher category, where the limitations of the higher category are complied with, or VAA–H, as applicable and the aerodrome is in sight; or
    - for an aerodrome without an authorised instrument approach procedure that the flight crew members of the aircraft are capable of using – within 3NM of the aerodrome reference point, and the aerodrome is in sight; or
    - within 5NM (7NM for a runway equipped with an ILS/GLS) of the aerodrome, aligned with the runway centreline and established not below "on slope" on the T-VASIS or PAPI; or
    - within 10NM (14NM for Runways 16L and 34L at Sydney) of the aerodrome, established not below the ILS/GLS glide path with less than full scale azimuth deflection.

*Note: Reference to circling area in this section includes the circling area for the category of aircraft or a higher category where the limitations of the higher category are complied with.*

- c. If in controlled airspace:
  - 1) a clearance is received from ATC to conduct a visual approach; and
  - 2) when tracking via a STAR and subsequently cleared for visual approach, the pilot continues to follow the lateral profile of the STAR, including any visual or instrument termination route; and
  - 3) except when on a STAR, the pilot maintains track/heading on the route progressively authorised by ATC until:
    - i (i) by day, within 5NM of the aerodrome; or
    - ii (ii) by night, the aerodrome is in sight and the aircraft is within the prescribed circling area for an IFR flight;

*Note: ATC will provide directions to the aircraft regarding how to join the circuit for the nominated runway from these positions.*

**1.16 Visual approach requirements for VFR flights**

1.16.1 If in controlled airspace and a clearance is received from ATC to conduct a visual approach, the pilot in command of an aircraft operating under the VFR must:

- a. maintain a level 500FT above the lower limit of CTA unless a clearance is received from ATC to depart and re-enter controlled airspace;
- b. maintain track/heading on the route progressively authorised by ATC until
  - i by day, within 5NM of the aerodrome; or
  - ii by night, the aerodrome is in sight and the aircraft is within 3NM of the aerodrome reference point.

*Note: ATC will provide directions to the aircraft regarding how to join the circuit for the nominated runway from these positions.*

**1.17 Handling Speeds**

1.17.1 The handling speeds for aircraft categories during IAL procedures are as follows:

SPEEDS FOR PROCEDURE IN KNOTS IAS					
ACFT CAT	V <sub>at</sub>	Range of Speeds for Initial and intermediate Approach	Range of Final Approach Speeds	Max Speeds for Visual Manoeuvring (Circling)	Max Speeds for Missed Approach
A	< 91	90-150 (110*)	70-100	100	110
B	91-120	120-180 (140*)	85-130	135	150
C	121-140	160-240	115-160	180	240
D	141-165	185-250	130-185	205	265
E	166-210	185-250	155-230	240	275
H	N/A	70-120	60-90	N/A	90
* Maximum speed for reversal procedures					

*Note 1: On reversal procedures (see section 2.8) for which a FAF is not published, final approach speed should be obtained before descending on the inbound track.*

*Note 2: Speed reduction below the initial segment speed range is permitted to enable the final approach speed to be achieved prior to the commencement of the final segment.*

### 1.18 Speed Restrictions

1.18.1 IAL charts may have speed restrictions identified on the chart when:

- a. handling speeds, below the maximum values specified in the table above, are required to contain the aircraft within the procedure design area; or
- b. the speeds are used for ATC flow management (ATC APCH speeds).

1.18.2 Where ATC APCH speeds do not align with the IAL procedure handling speeds, either at Table 1.1 or published on the chart, pilots must comply with the IAL procedure handling speeds. Notification to ATC is not required.

1.18.3 The following may amend the ATC APCH speed depicted on a STAR or IAL chart without approval or notification to ATC:

- a. Performance Category B aircraft may cross 5NM from THR at 145-160KT; or
- b. Performance Category A and H aircraft may fly lower speeds if required.

### 1.19 Obstacle Clearance Altitude (OCA)

1.19.1 Obstacle clearance altitude is:

- a. in a precision approach procedure, the lowest altitude at which a missed approach must be initiated to ensure compliance with the appropriate obstacle clearance criteria; or
- b. in a non precision runway approach procedure, the lowest altitude below which the aircraft cannot descend without infringing the appropriate obstacle clearance criteria; or
- c. in a visual (circling) procedure, the lowest altitude above the aerodrome elevation in accordance with obstacle clearance criteria.

### 1.20 Aerodrome Operating Minima (AOM)

1.20.1 Landing minima are published on Australian approach charts as MDA/H or DA/H. Obstacle Clearance Altitude/Height is not published. Landing minima are the basis for determining AOM.

1.20.2 ADF - Operators must establish AOM for each aerodrome to be used for operations. After consideration of the factors listed below, operators may determine that their AOM should be higher than the published landing minima:

- a. The type, performance and handling characteristics of the aircraft and any conditions or limitations stated in the flight manual.
- b. The composition of the flight crew, their competence and experience.
- c. The dimensions and characteristics of the runway that may be selected for use.
- d. The adequacy and performance of the available visual and non-visual ground aids.
- e. The equipment available on the aircraft for the purpose of navigation, acquisition of visual references, and control of the flight path, during the take-off, the approach, the flare, the landing, roll-out and missed approach.
- f. The obstacles in the approach, and missed approach and climb-out areas required for the execution of contingency procedures, and necessary clearance margins.
- g. The means used to determine and report meteorological conditions.
- h. The conditions prescribed in the operations specification.
- i. The minima promulgated for the instrument approach procedures.

1.20.3 **Partial runway lighting failure.** At a controlled aerodrome, in the event of failure of one electrical circuit on a runway equipped with interleaved circuitry lighting, pilots will be notified of a doubled spacing of runway edge lights; i.e., from 60M to 120M spacing. When such a failure occurs at night, pilots must apply the following requirements to an approach to land:

- a. In VMC:  
No restriction.
- b. In Less Than VMC:  
The prevailing visibility must be equal to, or greater than, the published minimum for the instrument approach procedure being used for an aircraft's arrival multiplied by a factor of 1.5.

**1.21 Descent Gradients**

1.21.1 Procedures are designed with the following descent gradients:

**TABLE 1.1: DECENT GRADIENTS**

SEGMENT	GRADIENT	
	NORMAL	MAXIMUM
Arrival	As required	As required
Initial	4%	8%
Intermediate	Level	5%
Final: non precision	5.2%	6.5%
precision	3°	Not applicable

*Note 1: The chart will indicate when other than a normal gradient is used in the final segment.*

*Note 2: For procedures published with a distance/altitude scale, a 3° glideslope is used in calculating the descent data.*

1.21.2 Aircraft may commence a segment in excess of the specified commencement altitude provided that any upper altitude limitation is observed. However, rate of descent after the FAF should not normally exceed 1,000FT per minute.

**1.22 Descent**

1.22.1 For a straight approach (no reversal procedure), the aircraft must:

- a. for a radio navaid-based approach, cross the fix or facility, or
- b. for an area navigation-based approach, pass the waypoint, and when established on the specified track, descend to not below the specified altitude.

1.22.2 For an approach which incorporates a reversal procedure, if an outbound descent is specified, the descent to the specified altitude may be commenced after the aircraft has crossed the fix or facility and is established on the specified track or has turned to a heading to intercept the specified outbound track. The reversal procedure must be completed, again descending to any lower altitude specified. Further descent, after the reversal procedure, must not be started until established on the inbound track. For approaches without a FAF, the final segment commences at the completion of the reversal procedure.

*Note: "Established" means being within half full scale deflection for the ILS, VOR and GNSS, within ±5° of the required bearing for the NDB, or within ±2NM of the DME arc.*

**1.23 Wind Effect**

1.23.1 Allowance should be made in heading and timing to compensate for the effects of wind. Full use should be made of indications available from the aid and estimated or known winds.

**1.24 Bank Angle**

1.24.1 Procedures are based on a bank angle of 25°, or a bank angle which will produce a Rate One turn, whichever is less.

## 2. APPROACH PROCEDURES

### 2.1 Operations On Parallel Runways At Class C Aerodromes

2.1.1 Parallel runways may be used for the following simultaneous operations:

- a. dependent parallel approaches;
- b. independent parallel approaches;
- c. dependent visual approaches;
- d. independent visual approaches;
- e. segregated parallel operations; or
- f. Simultaneous Opposite Direction Parallel Runway Operations (SODPROPS).

2.1.2 Refer to the relevant section of *AIP DAP* for location-specific procedures and guidance.

### 2.2 Use Of Navigation Aids

2.2.1 Instrument approach procedures are based on specific navigation aids, with the applicable navigation tolerances associated with the aids being used in the development of the procedure's obstacle protection surfaces. The navigation aid, or aids, upon which the procedure is based is/are identified on each instrument approach chart. Only the navigation aid, or aids, included in the chart title or identified on the instrument approach chart as suitable may be used to fly the procedure. Use of a non-specified aid (e.g. another DME located on the aerodrome) is prohibited as it may jeopardise the integrity of the instrument approach procedure.

### 2.3 Minimum Sector Altitude

2.3.1 25NM and 10NM MSAs provide 1,000FT obstacle clearance. An aircraft within the applicable 25NM Sector MSA or 10NM MSA may use the applicable MSA, and deviation from the track being flown is permitted to facilitate entry to the instrument approach. In instances where the 25NM MSA has been divided into sectors, and the appropriate 25NM Sector MSA is lower than the 10NM MSA (as a result of the 10NM MSA not being sectorised), then the 25NM Sector MSA may be used for tracking to the nominated significant point, ARP or HRP provided aircraft tracking can be maintained within the sector.

*Note: ADF - MSAs are calculated with reference to the appropriate nominated significant point, the ARP or HRP for the procedure or aerodrome. Military Instrument Flight Procedure diagrams note the nominated significant point, the ARP or HRP under the MSA diagram on each approach plate.*

### 2.4 Approach Design Concept

2.4.1 **Definitions.** "Segment Minimum Safe Altitude" and "Procedure Altitude are defined at GPA GEN 2.2 - Definitions and Abbreviations.

2.4.2 Approach procedures are designed to facilitate descent from a Procedure Altitude to an altitude from which a straight-in landing or a circling procedure can be conducted. Approach procedures are classified as either Precision Approach Procedure (PA), Approach Procedure with Vertical Guidance (APV) or Non-Precision Approach Procedure (NPA). NPA fall into two categories: those with distance measuring information (e.g. VOR/DME, LOC/DME, GNSS) and those without (e.g. NDB and VOR).

2.4.3 **Vertical profile - NPA with Distance Measuring.** NPAs with distance measurement are designed to provide a Constant Descent Final Approach (CDFA) path from the procedure altitude to a point 50FT above the threshold (or to the circling altitude for circling-only procedures). The CDFA path is shown on the profile diagram with the descent angle annotated in degrees and an altitude/distance scale. At each fix on the approach, an advisory crossing altitude is shown on the profile diagram to assist in maintaining the descent path. Each segment of an NPA also specifies a Segment Minimum Safe Altitude identified by shading on the profile diagram. In conducting a CDFA, the pilot should follow the descent profile but must always ensure that the aircraft remains at or above each Segment Minimum Safe Altitude. Descent below the CDFA profile to the Segment Minimum Safe Altitude (sometimes called "dive and drive") is permitted at pilot's discretion, but is not recommended.

2.4.4 **NPA as a 2D or 3D Operation.** An NPA procedure flown using the charted altitude/distance scale to determine the aircraft's rate of descent is considered a 2D instrument approach operation. Where the advisory vertical guidance is calculated and provided by on-board navigation equipment, the approach can be flown as a 3D instrument approach operation. Advisory vertical guidance is generated by aircraft navigation systems to assist pilots in managing vertical navigation but provides no assurance of compliance with the descent limitations specified for the NPA procedure. Accordingly, it is vital that pilots conform with



Segment Minimum Safe Altitude and MDA requirements regardless of any advisory vertical guidance information provided by the aircraft's system. NPA procedures using advisory vertical guidance will not be charted as VNAV capable. When flying an NPA as a 3D operation (e.g. CDF), pilots should initiate any missed approach at an altitude above the MDA to ensure the aircraft does not descend below the published MDA.

**2.4.5 Vertical profile - NPA Without Distance Measuring.** As these types of procedures are time based, a 3° profile cannot be published. Accordingly, a Procedure Altitude will be published to establish the top of descent at the beginning of the inbound leg. This altitude will provide the necessary obstacle clearance in addition to keeping the outbound and inbound rates of descent within the PANS-OPS limits.

**2.5 Procedure Entry**

2.5.1 An aircraft which is not required to hold or to lose height in a holding pattern may commence the approach without entering the holding pattern if:

- a. in controlled airspace, ATC has cleared the aircraft for the approach;
- b. in any airspace, for procedures using radio navaids:
  - 1) the reversal procedure entry requirements of [sub-section 2.8](#) are satisfied; or
  - 2) the DME arc entry requirements of [sub-section 2.9](#) are satisfied; or
  - 3) the en route track to the procedure's commencement fix or facility is within 30° either side of the first track of the procedure.
- c. for procedures using GNSS:
  - 1) in any airspace, the aircraft is tracking to an initial approach waypoint from within the capture region (see [Figure 2.3](#) and [Figure 2.4](#)) for that waypoint; or
  - 2) in controlled airspace, the aircraft is being vectored to intercept the initial approach segment or is tracking direct to the intermediate fix.

*Note to c.(1):* The first track of a GNSS procedure must be joined using the tracking guidance provided by the GNSS receiver.

*Note to c.(2):* "direct to" clearances may be requested to the intermediate fix (IF) provided that the resultant track change at the IF does not exceed 45°.

**Figure 2.3: RNAV GNSS (or RNP APCH) Approach Capture Regions (Three Initial Approach waypoints)**

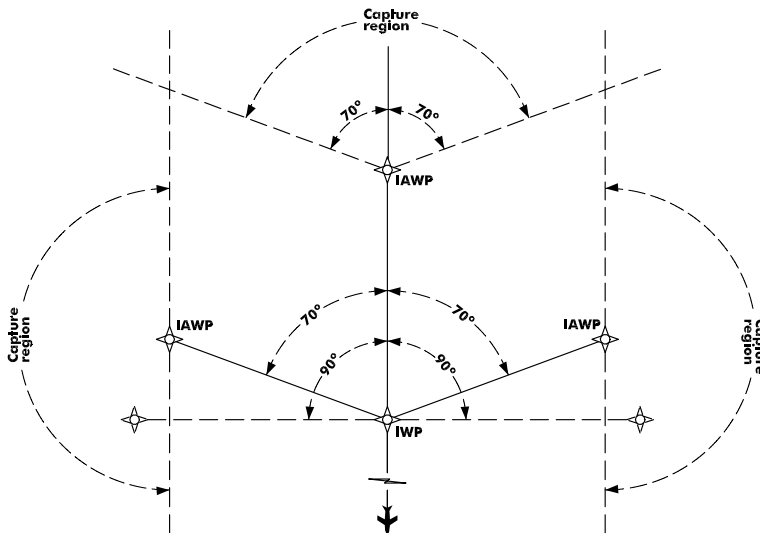
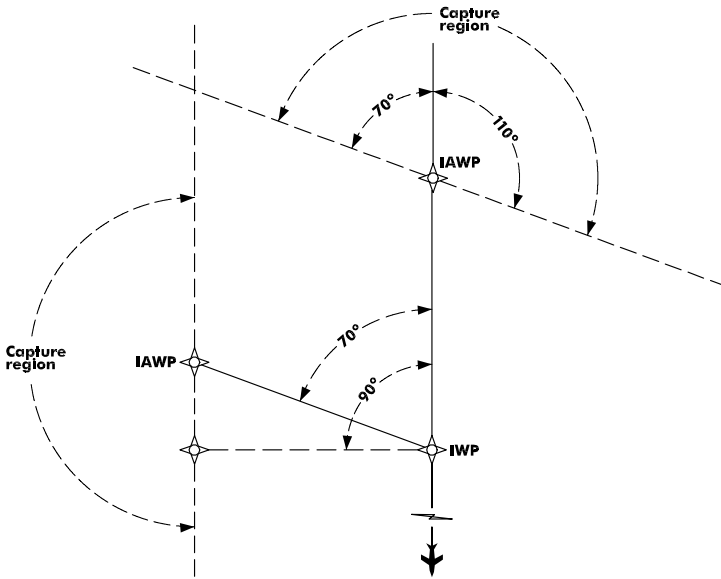

Figure 2.4: RNAV GNSS (or RNP APCH) Capture Regions (Two Initial Approach waypoints)



2.6 Approach Segments and Fixes

2.6.1 Fixes associated with segments occur at the beginning of their segment. The initial, final and missed approach fixes are shown. In addition, an area for circling the aerodrome in visual conditions is considered.

2.6.2 **Segment Parameters.** Segment parameters are defined in ICAO PANS OPS. Parameters significant to flight handling are as follows:

TABLE 1.2: SEGMENT PARAMETERS

SEGMENT	PARAMETER	VALUE/COMMENT
Arrival	As for en route flight	Nil
Initial	Descent gradient and rate	See <a href="#">paragraph 1.21</a>
	Bank angle	See <a href="#">paragraph 1.24</a>
Final	Speed	See <a href="#">sub-section 1.17</a>
	Navigation aid tracking	See <a href="#">paragraph 1.22</a>
Missed Approach	Nominal path gradient	2.5%
	Average achieved bank angle	15°
	Speed	See <a href="#">sub-section 1.17</a>

## 2.7 Missed Approach Procedure

2.7.1 The MAPT in a procedure may be:

- a. the point of intersection of an electronic glide path with the applicable DA/RA Height; or
- b. a navigational facility; or
- c. a fix; or
- d. a specified distance from the FAF, or
- e. a waypoint.

*Note: If the MAPT is defined by distance, a distance/groundspeed/time table will be provided to enable pilots to establish the MAPT by DR from the FAF.*

2.7.2 If on reaching the MAPT, the required visual reference is not established, the pilot must immediately initiate the published missed approach procedure or, where applicable, comply with alternative ATC instructions. The phrase “or as directed by ATC” is included in published missed approach instructions for applicable instrument approach procedures.

2.7.3 A published missed approach procedure must not be flown unless commenced at the MAPT. If a missed approach climb is initiated before the MAPT, the aircraft must track to the MAPT before commencing the missed approach procedure.

## 2.8 Reversal Procedures

2.8.1 **General.** Reversal procedures are used to establish the aircraft inbound on an intermediate or final approach track at the desired altitude. A reversal procedure consists of an outbound track followed by a turning manoeuvre in order to reverse direction onto the inbound track. The procedure can be a procedure turn or a base turn.

2.8.2 **Types.** Reversal procedures are illustrated at [Figure 2.5](#) and described below:

- a. **Procedure Turn (45°/180°)**, consisting of a specified outbound track and timing from the facility or fix, a 45° turn away from the outbound track for 1MIN from the start of turn for categories A and B aircraft (1MIN 15SEC from the start of turn for categories C, D and E aircraft), followed by a 180° turn in the opposite direction to intercept the inbound track [see [Figure 2.5 \(a\)](#)]. The 45°/180° procedure turn is an alternative to the 80°/260° procedure turn [paragraph b. below] unless specifically excluded.

*Note: Some instrument approach procedures require a procedure turn after passing over a navigation aid or fix. Where this requirement exists, the turn must be initiated immediately after passing over the navigation aid or fix.*

- b. **Procedure Turn (80°/260°)**, consisting of a specified outbound track and timing from the facility or fix, an 80° turn away from the outbound track, followed by a turn of 260° in the opposite direction to intercept the inbound track [see [Figure 2.5 \(b\)](#)]. The 80°/260° procedure turn is an alternative to the 45°/180° procedure turn unless specifically excluded.

*Note: Some instrument approach procedures require a procedure turn after passing over a navigation aid or fix. Where this requirement exists, the turn must be initiated immediately after passing over the navigation aid or fix.*

- c. **Base Turn**, consisting of a specified outbound track and timing or DME distance from a facility, followed by a turn to intercept the inbound track [see [Figure 2.5 \(c\)](#)]. The outbound track and/or time may be different for differing aircraft performance categories.

Figure 2.5: Reversal Procedures

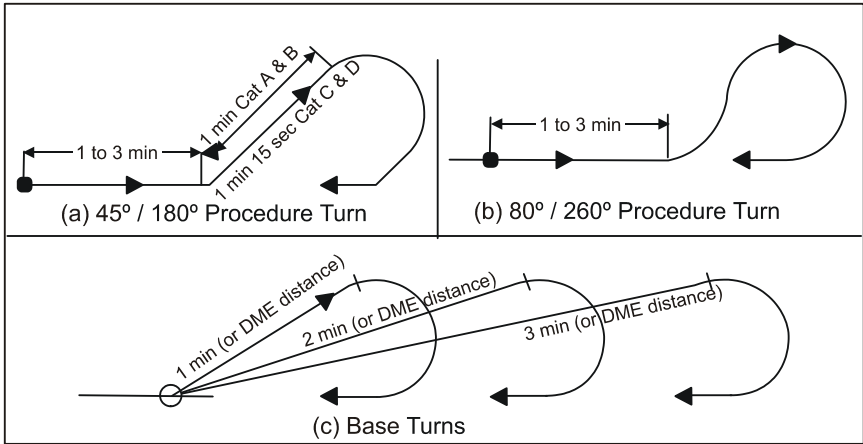

2.8.3 **Entry.** Reversal procedures must be entered from a track within  $\pm 30^\circ$  of the outbound track of the reversal procedure [see Figure 2.6]. However, for base turns, where the  $\pm 30^\circ$  direct entry sector does not include the reciprocal of the inbound track, the entry sector is expanded to include it [see Figure 2.7]. Where entry is required from tracks outside these limits, manoeuvring to establish the aircraft onto the outbound track must be in accordance with the entry procedures associated with the holding pattern

Figure 2.6: Direct Entry to Procedure Turn

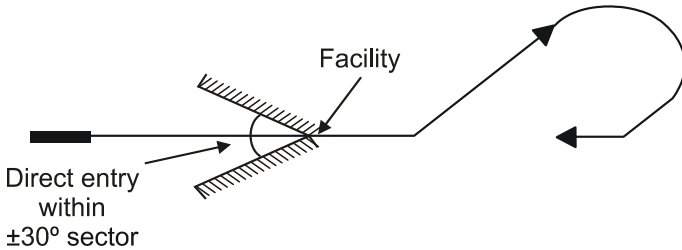
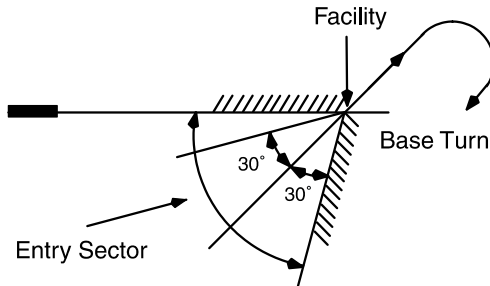

Figure 2.7: Direct Entry to Base Turn



2.9 DME Arcs

2.9.1 DME arcs must be joined at or before an IAF and at an altitude not below the relevant MSA or the appropriate sector DME Arrival step.

### 2.10 ADF - Procedure Containment

2.10.1 While the nominal track/s for instrument approach procedures published in TERMA will normally be contained within CTA (including military restricted areas when active), the holding and procedure tolerances may extend beyond the lateral airspace boundaries. The aircraft captain should ensure that traffic information, as appropriate, is obtained prior to commencement of the procedure where there is any possibility of the aircraft leaving CTA.

## 3. HOLDING PROCEDURES

### 3.1 General

3.1.1 When holding is required in a specified pattern the procedures set out in this section must be used.

3.1.2 Shape and terminology associated with a standard holding pattern are given in [Figure 3.1](#).

3.1.3 Right turns holding patterns are standard holding patterns and must be flown unless the AIP chart depicts, or ATC directs, otherwise.

3.1.4 ADF - Some area navigation systems are unable to fly non-area navigation holding patterns with strict compliance with the PANS-OPS, Volume II assumptions. These systems may not be used operationally unless the MAO has obtained approval in writing that the DASA is satisfied that the area navigation system commands will contain the aircraft within the basic holding area defined by PANS-OPS, Volume II for the environmental conditions assumed by those criteria. Where approval has been given, the pilot must verify overflight of the stipulated fixes by means of the reference facility.

### 3.2 Holding In Controlled Airspace

3.2.1 Pilots instructed to hold by ATC must hold at the designated location until further cleared.

3.2.2 ATC will normally assign aircraft estimated to arrive first over a holding fix, or first able to commence an approach, the lowest available level for assignment.

3.2.3 Where a delay of six minutes or more is expected, ATC will advise an expected approach time or expected landing time.

3.2.4 When operationally necessary, a pilot holding must advise ATC of the latest divert time.

3.2.5 When an aircraft is holding because weather conditions are worse than the prescribed landing minima, ATC will nominate scheduled reporting times, normally at 15 minute intervals.

3.2.6 At the time or position advised, the pilot must depart from the hold. A pilot should leave the holding fix on time, or up to one (1) minute ahead of time, and unless identified, report leaving the holding fix.

### 3.3 Limitations

3.3.1 Unless otherwise specified, holding procedures are subject to the following limitations:

- a. **Speed.** Indicated airspeed must not exceed
  - 1) up to and including FL140  
- 230KT, or  
- 170KT for holding where the approach is limited to Cat A and B aircraft only;
  - 2) above FL140 up to and including FL200, 240KT; and
  - 3) above FL200, 265KT.

*Note: Above the highest MSA in turbulent conditions, speeds may be increased to the lesser of 280KT or M0.8 subject to ATC approval in CTA.*

- b. **Outbound timing** begins abeam the fix or on attaining the outbound heading, whichever comes later.
- c. **Time/Distance outbound.** The outbound leg must be no longer than:
  - 1) up to and including FL140 - 1MIN or the time or distance limit specified on the chart;
  - 2) above FL140 - 1.5MIN or the time or distance limit specified on the chart.
- d. **Turns.** All turns in nil wind should be at a bank angle of 25° or Rate One, whichever requires the lesser bank.
- e. **Wind allowance.** Allowance should be made in heading and timing to compensate for the effects of wind to ensure the inbound track is regained before passing the holding fix inbound. Full use should be made of indications available from the aid and estimated or known winds.

- f. **Exiting.** For ATC traffic management, jet aircraft in CTA must leave an en route holding pattern at 250KT IAS, unless otherwise published or advised by ATC. Pilots may request a variation to this requirement.

**Figure 3.1: Shape and Terminology Associated with Right Turn Holding Patterns**

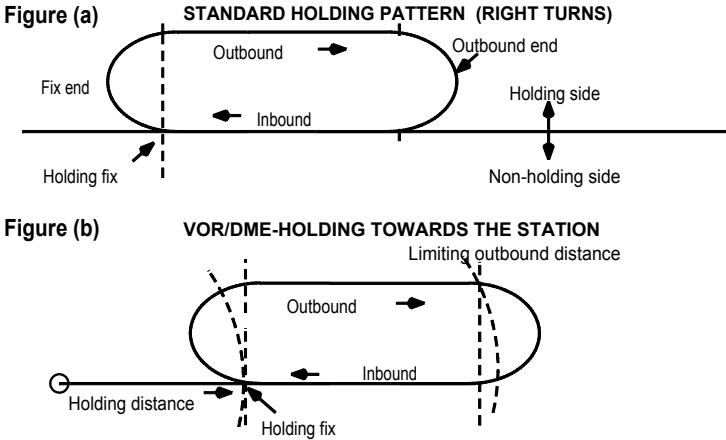

**3.4 Entry into the Holding Pattern**

3.4.1 The entry into the holding pattern must be according to heading in relation to the three entry sectors shown in Figure 3.2 a and b, recognising a zone of flexibility of 5° on either side of the sector boundaries. For holding on a VOR intersection, the entry track is limited to the radials forming the intersection. For holding on a VOR/DME fix the entry track is limited to either the VOR radial, DME arc or alternatively along the entry radial to a VOR/DME fix at the end of the outbound leg, as published.

**Figure 3.2 a: Right Turn Holding Procedure**

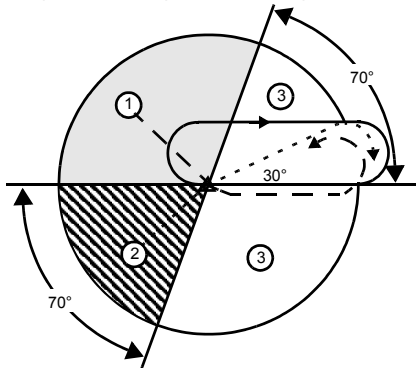
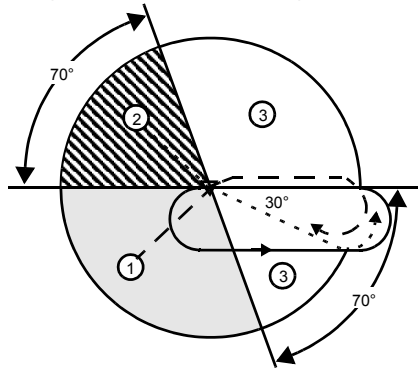

Figure 3.2 b: Left Turn Holding Procedure



**3.4.2 Entry from Sector 1 (Parallel entry):**

- a. On reaching the holding fix, the aircraft is turned onto an outbound heading (to track parallel with the inbound track) for the appropriate period of time (taken from over or abeam the holding fix whichever is later), or until reaching the limiting DME distance if earlier; then
- b. the aircraft is turned onto the holding side to intercept the inbound track or to return to the fix; and then
- c. on the second arrival over the holding fix, the aircraft is turned to follow the holding pattern.

**3.4.3 Entry from Sector 2 (Offset entry):**

- a. On reaching the holding fix, the aircraft is turned onto a heading to make good a track making an angle of 30° from the reciprocal of the inbound track on the holding side; then
- b. flown outbound:
  - 1) for the appropriate period of time from the holding fix, where timing is specified, up to a maximum of 1MIN 30SEC; or, if earlier,
  - 2) until the appropriate limiting DME distance is attained, where distance is specified; then
- c. the aircraft is turned in the direction of the holding pattern to intercept the inbound holding track; then
- d. on second arrival over the holding fix, the aircraft is turned to follow the holding pattern.

**3.4.4 Entry from Sector 3 (Direct entry).** On reaching the holding fix, the aircraft is turned to follow the holding pattern. Outbound timing begins abeam the fix or, when the abeam position cannot be determined, from completion of the outbound turn.

**3.4.5 DME Arc Entry.** Having reached the fix, the aircraft shall enter the holding pattern in accordance with either the Sector 1 or Sector 3 entry procedure.

**3.5 Standard Holding Pattern**

3.5.1 When flying the standard holding pattern, an aircraft must:

- a. follow the prescribed track inbound to the holding fix;
- b. execute a 180° turn in the direction specified, so as to fly outbound a track parallel to the inbound track;
- c. continue outbound to the earlier of the time, or the DME limit specified; and
- d. execute a 180° turn to realign the aircraft on the inbound track.

**3.6 DME limit**

3.6.1 The “DME limit”, where prescribed for holding patterns, is the DME distance at which the outbound leg of the holding pattern must be terminated and the turn to the reciprocal track commenced.

### 3.7 Shortening

3.7.1 The pilot may shorten the holding pattern to leave the holding fix at a specified time. For prolonged holding at a level not limited by obstacles, the length of the pattern may be increased, subject to ATC approval where appropriate.

### 3.8 Descent in Holding Pattern

3.8.1 Subject to ATC approval, where appropriate, aircraft may descend as required.

## 4. AERODROME METEOROLOGICAL MINIMA

### 4.1 Ceiling and Visibility Minima

4.1.1 The ceiling and visibility minima prescribed in this part are the meteorological conditions under which an aircraft may take-off or land at an aerodrome. The meteorological conditions for a particular aerodrome are below the minima for the aerodrome when, in the airspace encompassing the intended flight path:

- a. the total cloud amount below the ceiling minimum specified is continuously greater than SCT; or
- b. the visibility is continuously below the visibility specified.

*Note: MDA equals ceiling minimum plus the elevation of the aerodrome.*

### 4.2 Runway Visual Range and Runway Visibility

4.2.1 In Australia, Runway Visual Range (RVR) observations are based solely on the information provided by instrumented systems such as transmissometers. RVR observations representative of the touchdown, midpoint and roll out/stop end zones are automatically displayed in the local ATC unit. At locations where RVR information is accessible to the Bureau of Meteorology, the RVR is included in METAR and SPECI reports.

4.2.2 At places not equipped with RVR sensors or where one or more RVR sensors are unserviceable, a Runway Visibility (RV) assessment may be provided instead. A RV assessment is a report on the visibility in the touchdown and midpoint zones of a runway, and is assessed by a ground observer counting visible runway lights or visibility markers.

4.2.3 A RV assessment is NOT a substitute for a required RVR observation and CANNOT be used:

- a. for SA CAT I, SA CAT II, CAT II and CAT III precision approaches, or
- b. for CAT I approaches when the visibility is less than 800M, or
- c. for low visibility take-off where the visibility is less than 350M.

A RV assessment is a subset of a general visibility observation and is intended to provide visibility information specific to a particular runway; which may be more useful to a pilot than the overall ground visibility.

4.2.4 Pilots will be notified by ATIS broadcast or directed transmission if RVR/RV is not available when visibility is less than 800M.

4.2.5 See *GEN 3.4 para 6.9 Meteorological Information* for the relevant RVR/RV phraseologies.

### 4.3 ADF - IFR Take-off and Landing Minima

4.3.1 Refer to MAO OIP, relevant IAP and related AIP when determining the minimum weather conditions for take-off and landing. Criteria in ENR 1.5 Section 1.18 Aerodrome Operating Minima (AOM), and specified by CASA in the Part 91 MOS, Chapter 15, for IFR take-off and landing minima, are applicable to the ADF.

### 4.4 Correction of Instrument Procedure Minima for non-standard temperatures.

Pressure altimeters are calibrated to indicate true altitude under ISA standard conditions. Any deviation from ISA will result in an erroneous altimeter reading. In cold conditions the true altitude will be lower than the indicated altitude and will reduce the obstacle clearance margins incorporated into instrument procedures. Published landing minima do not make any allowance for non-standard temperatures at the QNH source (usually the aerodrome of destination). This effect, and various methods to address it, is discussed in *ICAO Doc 8168 (PANS-OPS), Vol III, Section 2, Chapter 4*. A correction must be added to the published MDA or DA and procedure altitudes when the temperature at the aerodrome of landing is less than ISA -15°C. Altitude corrections can be determined by charts DAP 2-2 and 2-3 and the worked example at DAP 1-1, paragraph 1.5 as detailed in the Departure and Approach Procedures (DAP) publications.



## 5. APPLICATION OF AERODROME METEOROLOGICAL MINIMA

### 5.1 Pilot Responsibilities

5.1.1 Prior to take-off and when an aircraft reaches the DA, MDA or RA Height, the aircraft captain is responsible for assessing whether the meteorological conditions are equal to or better than the minimum prescribed for take-off or landing as applicable. A pilot must not take off or, except in an emergency, land or continue an approach below the prescribed DA, MDA or RA Height for the approach being conducted when any element of the prescribed meteorological criteria is continuously less than the minima for the aircraft performance category.

### 5.2 ATC Assessment

5.2.1 Whilst the decision to operate is solely that of the aircraft captain, ATC will provide the aircraft captain with an assessment of ceiling and/or visibility as follows:

- a. **Take-off.** Ceiling and visibility will be assessed in the airspace enclosing the expected path of the aircraft during take-off and initial climb.
- b. **Landing.** Ceiling and visibility will be assessed in the airspace enclosing the expected final approach path and runway to be used.

### 5.3 QNH Sources

5.3.1 ADF - Prior to passing the IAF, pilots are required to set either:

- a. the actual aerodrome QNH from an approved source (AAIS, ATC, ATIS, AWIS, CA/GRS and WATIR), or
- b. the forecast Aerodrome (TAF) QNH, or
- c. the forecast area QNH.

5.3.2 Where instrument approach charts are identified by a shaded background to either the minima titles for IAL charts or the published minima for DME or GNSS Arrival Procedures, landing, circling and alternate minima have been calculated assuming the use of Aerodrome Forecast (TAF) QNH. These minima may be reduced by 100FT whenever an actual aerodrome QNH is set. Approved sources of actual QNH are ATC and ATIS except when the aerodrome forecast QNH is provided, AWIS and Bureau of Meteorology (BoM) accredited meteorological observers. An actual aerodrome QNH obtained from an approved source is valid for a period of 15 minutes from the time of receipt.

*Note: METAR QNH does not meet this requirement.*

5.3.3 When the actual aerodrome QNH is not available, ATC will report the Aerodrome Forecast (TAF) QNH on the ATIS. The ATIS will include information in the format "ACTUAL QNH NOT AVAILABLE, AERODROME FORECAST QNH...". (Note: Forecast QNH reported by ATC or on the ATIS is not an approved source of actual QNH).

5.3.4 Where the forecast Area QNH is used, the minima used must be increased by 50FT.

*Note: ADF - Where an aerodrome does not receive a regular TAF service, the IAL minima have already been adjusted therefore an additional 50FT is not required.*

*Where an aerodrome receives a regular TAF service, but the TAF is not available, the IAL minima must be increased by 50FT.*

*All Aerodromes listed at GPA GEN 3.5 section 16 are considered to have a regular TAF service.*

## 6. ALTERNATE WEATHER MINIMA

### 6.1 IFR Flights

6.1.1 **ADF** - Aircraft captains are to refer to ENR 1.1 paragraph 10.7.2.10 to determine the ceiling and visibility minima to be compared with the meteorological forecasts and reports to determine both the need to provide for an alternate aerodrome and the suitability of an aerodrome as an alternate.

### 6.2 Special Alternate Weather Minima

6.2.1 Special alternate weather minima are available for specified approaches at some aerodromes for use by aircraft with dual ILS/VOR approach capability. Dual ILS/VOR approach capability must include:

- a. duplicated LOC, and
- b. duplicated GP, and

- c. duplicated VOR, and
- d. either:
  - 1) duplicated DME, or
  - 2) duplicated GNSS, or
  - 3) single DME and single GNSS.

6.2.2 Special alternate weather minima are identified on applicable instrument approach charts by a double asterisk adjacent to the ALTERNATE title and a note detailing the special minima. These special alternate minima will not be available (minima will revert to the standard alternate minima) during periods when:

- a. local METAR/SPECI or forecasting services are not available; or
  - b. an aerodrome control service is not provided.
- The non-availability of MET or ATS services will be notified by NOTAM.

6.2.3 Where:

- a. there is a protracted unavailability (i.e., more than seven days) of any one VHF approach aid, or
- b. facilities required for the conduct of a VHF-based instrument approach and landing are unavailability or not available, Airservices Australia will, if necessary, advise the non-availability of, or any revision to, special alternate minima by NOTAM.

## 7. PRECISION APPROACH OPERATIONS

### 7.1 General

7.1.1 Precision approach operations involve the use of either ILS or GLS facilities.

7.1.2 An ILS supports all types of precision approach operations. The ground facilities comprise localiser equipment, glide path equipment and marker beacons, usually supported by an NDB or dedicated DME.

7.1.3 A GLS currently supports precision approach operations with minima as low as CAT I, but with the future potential for supporting CAT II and III operations. A GLS consists of a GBAS ground station located on or in the vicinity of one or more aerodromes and an aircraft sub-system. The GBAS provides data and corrections for the GNSS ranging signals over a digital VHF data broadcast to the aircraft sub-system. The aircraft sub-system translates the position signal into flight guidance similar to that provided for an ILS.

### ILS Caution:

1. False courses may exist or course reversals may occur outside the sector 35° (or 20° at certain aerodromes specified in ERSA) either side of an ILS localiser course.
2. Back beam radiation of an ILS LOC can be received and displayed on aircraft navigation instrumentation. Pilots should be alert to this possibility at locations providing ILS/LOC approaches on reciprocal runways.
3. A severe and sudden pitch-up upset can occur in cases where the aircraft:
  - a. intercepts an ILS glidepath from above; or
  - b. during an ILS approach, deviates significantly above the normal glide path angle. Caution should be exercised in such situations particularly for autopilot coupled approaches (See AIC H14/14).

### 7.2 Failures

- a. **NDB.** In the event of failure of an associated NDB, aircraft must join the ILS outside the outer marker as directed by NOTAM or ATC.
- b. **Glide path.** For ILS operations where the glide path fails, only the localiser procedure is available.
- c. **Markers.** Where marker beacons are not available, aircraft may use the ILS if the alternate fixes nominated on the IAL chart or by NOTAM are used for altimeter checks.
- d. **GBAS.** If GBAS fails, GLS approaches are not available.

### 7.3 Altimeter Checks and Flight Tolerances

7.3.1 The final approach segment contains a fix at which the glide path/altimeter relationship should be verified. If the check indicates an unexplained discrepancy, the ILS/GLS approach should be discontinued.

Pilots must conform to the following flight tolerances:

- a. To ensure obstacle clearance, both LOC/GLS final approach course and glideslope should be maintained within half scale deflection (or equivalent on expanded scale).
- b. If, at any time during the approach after the FAP, the LOC/GLS final approach or glideslope indicates full scale deflection a missed approach should be commenced.

### 7.4 Protection of GLS Critical and Sensitive Areas

7.4.1 There are no GLS critical and sensitive areas.

*Note: A CAT I GLS is not required to support autoland operations. Pilots are responsible for obtaining information necessary to make operational decisions to conduct a GLS autoland.*

## 8. STANDARD INSTRUMENT DEPARTURES

### 8.1 General

8.1.1 The pilot must advise ATC if cleared via a SID which requires the use of navigation aids not available to the aircraft.

8.1.2 SID procedures assume that pilots will not compensate for wind effects when being radar vectored, but will compensate for known or estimated wind effects when flying departure routes which are expressed as tracks.

8.1.3 SID procedures may be flown by aircraft already airborne provided that, before commencing a SID, the pilot visually positions the aircraft over the runway centre line so that all tracking and altitude restrictions can be met.

8.1.4 Each SID procedure specifies the minimum design climb gradient that ensures obstacle clearance. Where the initial required climb gradient exceeds 3.3%, the altitude at which a 3.3% climb gradient may be flown is also shown. A gradient shown in brackets specifies the climb gradient required to remain inside controlled airspace.

8.1.5 For aircraft on a radar SID, ATC will assign a departure heading (or track - see [paragraph 8.1.6](#)) to be flown after the initial take-off phase. The pilot is not to commence the take-off without having obtained the assigned departure heading or track and should advise ATC if the heading or track is unacceptable.

8.1.6 Instead of assigning a departure heading, ATC may instruct an aircraft to track the extended runway centre line for departure - if the first and only track on a radar SID is aligned with the runway bearing.

8.1.7 The climb gradient shown on a radar SID chart provides obstacle clearance up to the MSA/LSALT. If a SID chart has multiple climb gradient sectors, ATC will not issue heading instructions to an airborne aircraft that would require the pilot to adopt a higher climb gradient than the gradient specified for the initial departure heading.

8.1.8 When the aircraft is above the MVA, any subsequent changes of headings are ATC vectors and ATC will issue instructions that ensure prescribed obstacle clearance will exist at all times.

8.1.9 The climb gradient requirements of a Radar SID cease when the aircraft reaches the MSA/LSALT as applicable.

*Note: ADF – Aircrew should be aware of the potential tracking errors associated with coded terminal procedures in some FMS. On long terminal procedure legs (in excess of 50NM without a fix) a cross-track error may be experienced due to FMS magnetic variation differences and/or procedure coding limitations. The resulting errors are proportional to both the magnetic variation difference and the length of the affected procedure leg.*

### 8.2 SID Procedures

8.2.1 Unless explicitly cancelled or amended by ATC, the pilot must follow the vertical and lateral profile of the SID and comply with any published speed restrictions.

8.2.2 The use of a SID designator without a cleared level does not authorise the pilot to climb on the SID vertical profile.

8.2.3 A level restriction depicted on a SID chart does not authorise a pilot to climb to meet that restriction. ATC will assign climb to permit compliance with vertical navigation restrictions. Pilots must inform ATC if a level restriction cannot be met.

8.2.4 ATC level change instructions to aircraft on a SID will indicate if published level and/or speed restrictions are to be followed or are cancelled.

8.2.5 When conducting a SID, the priority is to meet the vertical navigation restrictions of the SID. When speed restrictions do not enable the aircraft to meet a SID level restriction, the pilot must advise ATC of any speed deviation requirement at ACD stage or as soon as the situation is identified. Pilots must advise ATC when able to resume the SID speed restrictions.

8.2.6 For ATC traffic management: unless varied by ATC, DAP or ERSA, at or before 3,000FT AGL or at the completion of a noise abatement procedure, jet aircraft departing Class C aerodromes must:

- a. commence acceleration to 250KT IAS; and
- b. maintain 250KT until leaving 10,000FT AMSL.

The pilot must advise ATC, preferably at ACD stage, if the aircraft will be unable to comply.

8.2.7 Cancellation of 'published speed restrictions' cancels all speeds published on the SID chart. Cancellation of 'ATC-issued speed control instructions' cancels any speed control instructions issued by ATC. Airspace speed limitations must be complied with unless specifically cancelled.

8.2.8 When a departing aircraft is cleared to proceed direct to a published waypoint on the SID, the speed and level restrictions associated with the bypassed waypoints are cancelled. The pilot must comply with any published SID speed and level restrictions, at and after the waypoint where the SID is rejoined. An aircraft cleared to bypass one or more waypoints on a SID will not receive a specific instruction to rejoin the SID.

8.2.9 When a departing aircraft is vectored or cleared to proceed away from the SID, all the published speed and level restrictions of the SID are cancelled. ATC will notify the pilot if there is an expectation the aircraft will subsequently rejoin the SID.

*Note: Unless specifically cancelled by ATC, any ATC traffic management speed specified in ERSA will apply to aircraft when vectored or cleared away from a SID.*

8.2.10 ATC instructions to rejoin a SID will specify any transition restrictions that must be complied with up to, but not including the waypoint where the SID is rejoined. The pilot must comply with any published SID speed and level restrictions, at and after the waypoint where the SID is rejoined.

8.2.11 In a surveillance environment prior to take-off, ATC may cancel a procedural SID and:

- a. issue a radar SID; or
- b. require the aircraft to depart on runway track using the climb gradient specified in the cancelled SID. In this case, ATC will use the phrase "CANCEL SID, TRACK EXTENDED CENTRE LINE (three digits) DEGREES".

*Note: For the application of this procedure, the runway and radar SID tracks must be coincident up to the MVA.*

8.2.12 In VMC by day, the pilot may request, or ATC may offer a visual departure.

8.2.13 When a departure report is required during a SID, the SID designator must be included in the report.

8.2.14 For a Radar SID, the direction of turn and assigned heading must be advised in the airborne report.

## 9. NOISE ABATEMENT PROCEDURES

### 9.1 Application

9.1.1 Noise Abatement Procedures (NAP) normally apply to all jet-propelled aircraft and other aircraft having a MTOW exceeding 5,700KG.

*Note: A subsonic jet-propelled aircraft will not be permitted to operate in Australia unless it meets the requirement of ICAO ANNEX 16, VOL 1, Chapter 3.*

9.1.2 Where noise abatement procedures are prescribed, and ATC traffic management permits, the runway nomination provisions of DAP NAP or TERMA will be applied. Notwithstanding this, noise abatement will not be a determining factor in runway selection under the following circumstances (unless required by Noise Abatement legislation):

- a. in conditions of low cloud, thunderstorms and/or poor visibility;
- b. for runway conditions that are completely dry:
  - 1) when the crosswind component, including gusts, exceeds 20KT;
  - 2) when the tailwind component, including gusts, exceeds 5KT;
- c. for runway conditions that are not completely dry:
  - 1) when the crosswind component, including gusts, exceeds 20KT;
  - 2) when there is any tailwind component;
- d. when wind shear has been reported;
- e. when, in the opinion of the aircraft captain, safety would be prejudiced by runway conditions or any other operational consideration.

9.1.3 Preferred flight paths for arriving and departing aircraft have been determined for particular locations. For departing aircraft they may be in the form of a SID. Arriving aircraft must not make approaches to land below the visual or electronic glide paths for the runway in use. The requirement to follow the noise abatement flight paths shall be subject to a specific ATC clearance or instruction, and may be varied by ATC for operational reasons, eg weather, traffic complexity.

9.1.4 Aircraft operating outside tower hours of operation (at locations which do not have continuous tower services) must comply with relevant noise abatement procedures only where they do not conflict with circuit direction requirements detailed in the ERSA entry for that location.

9.1.5 ADF - Noise abatement departure procedures will be developed by the operator for each aeroplane type in accordance with the requirements of ICAO Procedures for Air Navigation Services - Aircraft Operations (PANS-OPS) Vol. I, Part 1, Section 7, Chapter 3.

9.1.6 Noise abatement departure procedures must be used by jet propelled aircraft from the locations and runways identified under the NAPs published in DAP East and West. The departure procedure to be used on a specific departure should satisfy the noise abatement objectives of the aerodrome operator in alleviating noise either close to the aerodrome or distant from the aerodrome. Examples of such procedures are given in PANS-OPS Vol. I, Part 1, Section 7, Chapter 3 (NADP 1 and NADP 2).

*Note 1: NADP 1 and NADP 2 are EXAMPLES only. The actual procedures developed by the operator for a specific aircraft type may vary from these examples provided the minimum requirements of the procedures are met.*

*Note 2: The power settings to be used subsequent to the failure or shutdown of an engine or any other apparent loss of performance, at any stage in the take-off or noise abatement climb, are at the discretion of the aircraft captain, and noise abatement considerations no longer apply.*

9.1.7 As an alternative to the procedures detailed in [paragraph 9.1.6](#), operators of aircraft which have engines with a by-pass ratio greater than 3.5 may use the procedure detailed below:

- a. climb at  $V_2+10KT$  to  $V_2+20KT$  - or body angle limit speed; and
- b. maintain take-off power to a height above the aerodrome of 1,000FT;
- c. then maintaining a positive rate of climb, accelerate to zero flap minimum safe manoeuvring speed ( $V_{ZF}$ ) retracting flap on schedule;
- d. then reduce to normal climb power/thrust; and

*Note: For aeroplanes with slow flap retraction, reduce power/thrust at an intermediate flap setting.*

- e. continue climb at not greater than  $V_{ZF}+10KT$  to a height above the aerodrome of 3,000FT;
- f. accelerate smoothly to en route climb speed; and
- g. maintain runway heading unless required to do otherwise in accordance with a SID or specific ATC instruction.

## 9.2 Curfews

9.2.1 There are curfews on some operations at Adelaide, Gold Coast, Essendon and Sydney airports. For details, see Airservices Australia DAP East/West NAP for those airports.

## 10. STANDARD INSTRUMENT ARRIVALS (STARS)

### 10.1 General

10.1.1 The pilot must advise ATC if cleared via a STAR which requires the use of navigation aids not available to the aircraft.

10.1.2 When a STAR includes more than one instrument termination procedure, pilots must plan to fly the procedure listed first on the chart, for that runway. If the listed termination procedure is not available, e.g. the ILS is not available, pilots must plan for the next listed procedure.

10.1.3 An operational requirement or pilot request for an alternative instrument termination procedure should be made prior to the STAR being issued.

10.1.4 Unless the pilot requests an alternative approach, flights that have included PBN/T1 in Field 18 of the flight notification form will normally be issued a STAR with an RNP AR termination (where published) or an expectation of an RNP AR approach.

*Note: At some locations traffic complexity may prevent allocation.*

10.1.5 When a clearance for the termination procedure is authorised e.g. visual approach, the published STAR speed restrictions still apply unless specifically cancelled.

### 10.2 STAR Procedures

10.2.1 Unless explicitly cancelled or amended by ATC, the pilot must follow the vertical and lateral profile of the STAR and comply with any published speed restrictions.

10.2.2 The use of a STAR designator without a cleared level does not authorise the pilot to descend on the STAR vertical profile.

10.2.3 A level restriction depicted on a STAR chart does not authorise a pilot to descend to meet that restriction. ATC will assign descent to permit compliance with vertical navigation restrictions. Pilots must inform ATC if a level restriction cannot be met.

10.2.4 ATC level change instructions to aircraft on a STAR will indicate if published level and/or speed restrictions are to be followed or are cancelled.

10.2.5 Cancellation of 'published speed restrictions' cancels all speeds published on the STAR chart. Cancellation of 'ATC-issued speed control instruction' cancels any speed control instructions issued by ATC. Airspace speed limitation must be complied with unless specifically cancelled.

10.2.6 When an arriving aircraft is cleared to proceed direct to a published waypoint on the STAR, the speed and level restrictions associated with the bypassed waypoints are cancelled. The pilot must comply with any published STAR speed and level restrictions at and after the waypoint where the STAR is rejoined. An aircraft cleared to bypass one or more waypoints on a STAR will not receive a specific instruction to rejoin the STAR.

10.2.7 When an arriving aircraft is vectored or cleared to proceed away from the STAR, all the published speed and level restriction of the STAR are cancelled. ATC will notify the pilot if there is an expectation the aircraft will subsequently rejoin the STAR.

*Note: Unless specifically cancelled by ATC, any ATC traffic management speed specified in ERSA will apply to aircraft when vectored or cleared away from a STAR.*

10.2.8 ATC instructions to rejoin a STAR will specify any transition restrictions that must be complied with up to, but not including the waypoint where the STAR is rejoined. The pilot must comply with any published STAR speed and level restrictions, at and after the waypoint where the STAR is rejoined.

10.2.9 Following holding, pilots can expect to continue the previously issued STAR. ATC will indicate if published level and/or speed restrictions are to be followed or are cancelled.

10.2.10 Where a STAR incorporates circuit legs to a runway, pilots of aircraft not equipped with a flight management system may accept the STAR clearance and request vectors when contacting Approach Control.

## 11. DME OR GNSS ARRIVAL PROCEDURES

### 11.1 General

11.1.1 **ADF** - The DME or GNSS Arrival Procedure is an Australian unique instrument approach procedure that provides descent guidance along a specified track or sector, to the visual circling area of an aerodrome, aircraft landing area or helicopter landing site. Azimuth guidance is required from the specified radio navigation aid or by a direct track to the reference waypoint. *Subsections 1.6, 1.9 and 1.13 apply.*

*Note 1: ADF - In this section, reference to DME includes the use of TACAN for distance measurement where TACAN Arrivals are published, provided that all tolerances and conditions shown for DME are applied.*

11.1.2 Descent is not permitted until the aircraft is established within the appropriate sector or on the specified inbound track.

11.1.3 If manoeuvring within a sector is required, the pilot must ensure that the aircraft is contained within the sector, at or above the appropriate segment minimum safe altitude. Manoeuvring within a sector after passing the final approach fix is prohibited.

### 11.2 Operations in Controlled Airspace

11.2.1 The clearance "CLEARED DME (or GNSS) ARRIVAL" constitutes a clearance for final approach and authorises an aircraft to descend to the minimum altitude specified in the appropriate DME or GNSS Arrival Procedure. ATC is not permitted to impose any altitude restriction on such a clearance.

11.2.2 When cleared for a DME or GNSS Arrival in controlled airspace an aircraft must not orbit, enter a holding pattern, or use holding pattern entry procedures. ATC will not issue a clearance for a DME or GNSS Arrival that involves the use of a holding pattern entry procedure.

11.2.3 When ATC cannot issue a clearance for an unrestricted DME or GNSS Arrival, the phrase "DESCEND TO (level) NOT BELOW DME (or GNSS) STEPS" may be used. Such an instruction authorises descent in accordance with the DME or GNSS steps only to the specified altitude.

11.2.4 ATC may clear an aircraft to intercept the final approach segment of another instrument approach procedure. When clearing an aircraft for such a procedure, ATC will use the phrase "DESCEND TO (level) NOT BELOW DME (or GNSS) STEPS" and will issue further instructions prior to the aircraft's reaching the cleared level.

11.2.5 Nothing in these procedures absolves the aircraft captain from their responsibilities to maintain the aircraft on the authorised track or within the defined sector.

*Note 1: Where the track being flown is not aligned with the landing runway, a clearance for a DME or GNSS Arrival includes a clearance to manoeuvre within the circling area to position the aircraft on final for landing.*

*Note 2: Where possible, DME and GNSS Arrival procedures are designed to contain the aircraft within controlled airspace and provide 500FT separation from the CTA lower limit. However, there are locations where the procedure commences in Class G airspace, or which can take aircraft into Class G airspace on descent. Pilots should check procedures to ensure that aircraft are contained in CTA where required. In Class G airspace separation from other traffic remains the responsibility of the aircraft captain. (This last sentence retained from FIHA 17NOV11 edition as a caution to the aircraft captain)*

### 11.3 ADF - DME/GNSS Arrival Chart Format

11.3.1 **Descent Profile.** DME and GNSS steps do not imply a requirement to adopt a stepped descent profile. Descents may be conducted at any suitable rate unless a rate of descent is specified by ATC. In no circumstances shall an aircraft descend below the limiting altitude specified in the table of DME or GNSS steps.

11.3.2 **Minima.** The approved minimum altitude and minimum flight visibility are shown for each procedure in the tabulation.

11.3.3 **Circling Restrictions.** Circling restrictions, as depicted on IAL charts, apply to DME and GNSS Arrival Procedures at night and by day in less than VMC.

#### 11.3.4 DME and GNSS Arrival Chart Columns:

Column 1: The name and elevation of the aerodrome for which the procedure is designed and the magnetic track towards the azimuth facility or the approved sector for which the procedure is designed.

Column 2: The LSALT over the last route segment to the aerodrome or the LSALT appropriate to the approved sector. The sector LSALT is distance limited.

Columns 3-11: The "descent step" is shown as a figure (DME or GNSS distance) over a downward-pointing arrow (minimum altitude), e.g.

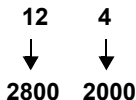

Using this example, an aircraft may commence (or continue) a descent at 12DME or GNSS to 2,800FT. The aircraft must not descend below 2,800FT until 4DME or GNSS, where it may continue descent to 2,000FT.

Column 12: **ADF** - The final descent step and MDA, with prescribed visibility, expressed in metres (kilometres in Airservices Australia DAP) by aircraft performance categories. When a performance category is not indicated, the minima applies to all categories.

## 12. SIGNALS FOR THE CONTROL OF AERODROME TRAFFIC

### 12.1 Light Signals to Aircraft

Light Signal	Meaning in Flight	Meaning on Aerodrome
Steady Green	Authorised to land if pilot satisfied no collision risk exists.	Authorised to take-off if pilot satisfied no collision risk exists.
Steady Red	Give way to other aircraft and continue circling.	Stop.
Green Flashes	Return for landing.	Authorised to taxi if pilot satisfied that no collision risk exists.
Red Flashes	Aerodrome unsafe - do not land.	Taxi clear of landing area in use.
White Flashes	No significance.	Return to starting point on aerodrome.

### 12.2 Light Signals to Vehicles and Pedestrians

Light Signal	Meaning
Green Flashes	Permission to cross landing area or to move onto taxiway.
Steady Red	Stop.
Red Flashes	Move off the landing area or taxiway and watch out for aircraft.
White Flashes	Vacate the manoeuvring area in accordance with local instructions.
<i>Note: In emergency conditions or if the above signals are not observed, the following meaning will be indicated by the use of the runway or taxiway lighting.</i>	
Flashing runway or taxiway lighting	Vacate the runway or taxiway and observe the tower for light signal.

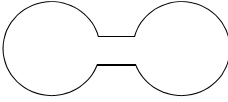
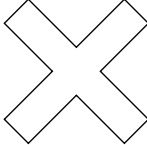
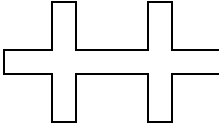

12.3 Ground Signals to Aircraft

Ground Signal	Description	Where displayed	Meaning
	Horizontal white dumb-bell	Adjacent to wind direction indicator.	Use only hard surface movement areas. Where there are sealed and gravel manoeuvring areas, use only the sealed surfaces. Where there are constructed gravel and natural surface manoeuvring areas, use only the gravel surfaces. (See ERSA for any local information relating to the dumb-bell signal.)
	White Cross	(i) Adjacent to wind direction indicator. (ii) On manoeuvring area.	(i) Aerodrome completely unserviceable. (ii) An area marked by a cross or crosses with the limit delineated by markers is unfit for use by aircraft.
	White Double Cross	Adjacent to wind direction indicator.	Gliding operations in progress.



## ENR 1.6 ATS SURVEILLANCE SERVICES AND PROCEDURES

### 1. RADIO COMMUNICATIONS PROCEDURES

1.1 Pilots requesting ATS surveillance service should address their request to the ATS unit with which they are communicating.

1.2 Where an Area Approach Control Centre (AACC) is not established, the pilot will be advised the time or place to transfer to a control frequency.

1.3 Where an AACC is established, procedural and ATS surveillance services may be provided on a common frequency. The call-sign identifies the service being provided; e.g.,... CENTRE,... APPROACH,... DEPARTURES.

### 2. IDENTIFICATION PROCEDURES

2.1 Before providing an ATS surveillance service there will be positive identification of the aircraft concerned. However, control services will not be provided until the aircraft is within controlled airspace.

### 3. VECTORING PROCEDURES

3.1 On receipt of heading instructions the pilot must, unless otherwise instructed, immediately commence a rate 1 turn, or the standard rate of turn for the aircraft type, and then maintain the heading given.

3.2 Aircraft will normally be vectored on routes along which the pilot can monitor navigation.

3.3 ATC are not permitted to vector Special VFR flights, unless warranted by emergency conditions.

3.4 When an aircraft is given a vector which will take it off an established route, the pilot will be advised of the reason for the vector, unless it is self-evident.

3.5 When an aircraft reports unreliable directional instruments, the pilot will be requested, prior to the issuance of manoeuvring instructions, to make all turns at an agreed rate and to carry out the instructions immediately on receipt.

3.6 When aircraft are being vectored, the controller will assign altitudes which allow for terrain clearance. However, in VMC by day, an aircraft may be permitted to arrange its own terrain clearance. In such instances, the aircraft will be instructed to [TURN LEFT (or RIGHT) HEADING (heading)] [CLIMB (or DESCEND) TO (level)] VISUAL.

3.7 Pilots being vectored will be routinely advised of their position to enable pilot navigation in the event of communication or ATS surveillance system failure.

3.8 The interval between ATC transmissions will be kept short to enable the pilot to quickly recognise a communication failure. When aircraft are on headings that could infringe terrain clearance or separation standards, the interval between transmissions will not exceed 30SEC.

3.9 Before take-off, ATC may assign a heading for a departing aircraft to assume after take-off, followed by frequency change instructions if appropriate. Headings, other than those assigned for a RADAR SID, will only be issued for a visual departure by day in VMC.

3.10 Arriving aircraft may be vectored to:

- a. establish for a RADAR or pilot-interpreted approach;
- b. a position from which a visual approach can be made;
- c. avoid areas of hazardous weather or severe turbulence;
- d. expedite traffic flow or conform to noise abatement requirements.

3.11 For a pilot-interpreted approach, aircraft will be vectored to be established on final track at least 2NM prior to commencement of final approach. The final intercept heading will normally intercept the final approach track at an angle of 45° or less. When an aircraft is vectored for a shortened instrument approach, the final approach point is the interception of the prescribed descent profile.

3.12 Should the aircraft have to be vectored through the final approach track, the controller will advise the pilot.

3.13 When the aircraft is provided with the vector to intercept final for a pilot-interpreted approach, the pilot will be:

- a. advised of range from the aerodrome, or position reference the final approach point;
- b. informed that the vector is to intercept the approach aid;
- c. provided with a clearance for the approach, when such a clearance has been authorised; and
- d. instructed to report when established on the final approach track.

*Note: When ILS/GLS is used for final approach, pilots should report when established on the localiser or final approach course and not delay this report until the glide path is intercepted.*

3.14 When the pilot reports established on final, they shall be instructed when to transfer to the tower frequency.

3.15 Unless otherwise instructed, the aircraft captain should change automatically to tower frequency, provided that:

- a. the aircraft is established on the final approach track and has been cleared for final approach; and
- b. air-ground communications congestion or failure has not allowed the pilot to report ESTABLISHED, or obtain a clearance to transfer to tower; and
- c. transfer to tower shall not be prior to 4NM from touchdown.

3.16 A vectoring service will not normally be terminated until the aircraft is established within the navigation tolerance of its cleared route, except on transfer to tower. However, subject to identification contact, a vectoring service will be continued, if requested.

3.17 When a vectoring service is terminated, the pilot will be:

- a. provided with position information including, if applicable, displacement from the nominated track; and
- b. provided with a heading or track clearance to intercept the nominated track for the pilot-interpreted navigation aid; or
- c. provided with a track clearance direct to a waypoint to intercept the nominated track (for an RNAV or RNP approved aircraft).

3.17.1 **ADF** - Military aircraft under the control of a Defence controller do not need to be provided with position information when terminating vectors.

3.18 Position information will be passed to aircraft in one of the following forms:

- a. a bearing and distance (using points of the compass) from the ARP, a navigation aid, or a known position;
- b. a heading and distance to the appropriate reporting point, en route navigation aid, or approach aid;
- c. over a well known geographical position; or
- d. a distance to the runway touchdown (as track miles to run).

3.19 An aircraft under ATS surveillance service control will be advised of its position in the following circumstances:

- a. on identification, unless the identification is established,
  - i based on the pilot's report of the aircraft position, or within 1NM of the runway on departure, if the observed position on the situation display is consistent with the aircraft's time of departure; or
  - ii by use of ADS-B aircraft identification, SSR Mode S aircraft identification or assigned discrete SSR codes if the location of the observed position indication is consistent with the current flight plan of the aircraft; or
  - iii by transfer of identification
- b. when pilot requests position information;
- c. when the pilot's position or estimate differs significantly from the controller's estimate based on the observed position;
- d. when the pilot is instructed to resume own navigation after vectoring if the current instructions had diverted the aircraft from a previously assigned route (**ADF** - excluding military aircraft under the control of a Defence controller);

- e. immediately before termination of ATS surveillance service, if the aircraft is observed to deviate from its intended route;
- f. as soon, after first contact with approach RADAR control, as a distance to run to touchdown becomes evident;
- g. when a regular circuit pattern is used to vector on to the final approach path (at least once on each leg);
- h. when a straight-in approach is provided.

**4. ATC RESPONSIBILITIES IN RESPECT OF UNIDENTIFIED AIRCRAFT**

4.1 ATC has no responsibility to initiate avoiding action for aircraft in controlled airspace in respect of unidentified aircraft which can reasonably be assumed to be outside controlled airspace.

4.2 If an aircraft is likely to be a hazard to controlled aircraft receiving an ATS surveillance service, the controller will take appropriate action to preserve the safety of the controlled aircraft.

4.3 Where there is an ATS surveillance service in non-controlled airspace, identified IFR aircraft and VFR aircraft receiving a SIS will be provided with traffic information about known conflicting aircraft, unless it is impracticable. If requested by the pilot and if possible, a course of avoiding action will be suggested.

4.4 Traffic information in respect of an unidentified aircraft will normally take the following form:

- a. relative position of the unidentified aircraft to aircraft track in terms of the 12 hour clock except that, if the identified aircraft is turning, relative position will be specified by reference to compass points;
- b. distance from the unidentified aircraft in miles;
- c. direction in which the unidentified aircraft appears to be proceeding.

**5. SPEED CONTROL (ARRIVING AIRCRAFT)**

5.1 To facilitate the provision of ATS surveillance services in controlled airspace, a pilot of a controlled flight may expect the application of speed control. ATC-issued speed control instructions refer to indicated airspeed or Mach number.

5.2 The pilot must request an alternative when an ATC-issued speed control instruction is unacceptable on operational grounds.

5.3 When the application of speed control can be foreseen, a pilot will be advised of future intentions.

5.4 An ATC-issued speed control instruction, whilst in force, explicitly cancels published speed restrictions.

*Note: Airspace speed limitations still apply.*

5.5 A pilot will be advised when a specific ATC-issued speed control instruction is no longer necessary. Unless otherwise stated, an ATC-issued speed control instruction applies until the aircraft reaches the point in the descent profile where the speed would normally be reduced below that assigned by ATC. Except for a STAR, a DME arrival, or unless otherwise specified, a clearance for final approach or a clearance for a visual approach terminates speed control.

**6. EMERGENCY PROCEDURES**

**6.1 General**

6.1.1 All possible assistance will be given to aircraft in distress.

**6.2 Radio Failure Procedure**

6.2.1 When an aircraft is being vectored the interval between radio transmissions is short. Pilots should make a radio check if no transmission is heard after a reasonable interval.

6.2.2 In the event of failure of two-way communications while receiving an ATS surveillance service, the pilot must change to the alternative frequency and request instructions.

6.2.3 If unable to make contact on the alternative frequency, the pilot must comply with standard radio failure procedures.

6.2.4 If able to receive but not transmit, the pilot must remain on the assigned frequency and comply with instructions issued which are designed to establish that the aircraft is receiving. If this is established, further instructions will be issued.

### 6.3 ATS Surveillance System - Failure Procedure.

6.3.1 In the event of ATS surveillance system failure, or loss of identification, appropriate instructions will be issued.

### 6.4 SSR Emergency Codes

6.4.1 The pilot of an aircraft encountering an emergency in flight, other than loss of two-way communications, should select code 7700 unless they have specific reason to believe that maintaining the assigned code would be the better course of action.

6.4.2 The pilot of an aircraft subject to unlawful interference should select code 7500. On receipt of this code the controller will:

- a. request confirmation of the setting of the assigned code as follows: "CONFIRM SQUAWKING ASSIGNED CODE". (The absence of a reply in these circumstances shall be regarded as positive evidence of the emergency);
- b. provide the aircraft with priority in all respects;
- c. transmit all useful information pertinent to the conduct of the flight without expecting a reply from the aircraft;
- d. avoid references to the nature of the emergency except if it is first referred to by the pilot;
- e. monitor and plot the progress of the flight;
- f. coordinate transfer of control, as appropriate, without requiring responses from the aircraft, unless communication remains normal; and
- g. relay messages as required between the aircraft and appropriate authorities.

6.4.3 The pilot of an aircraft losing two-way communication must set the transponder to code 7600.

6.4.4 A controller observing a 7600 code shall request the pilot to operate the identification (SPI) function. If the identification signal is received, further control of the aircraft will be continued using the identification transmission to acknowledge receipt of instructions issued.

6.4.5 If the identification signal is not received, the aircraft must continue with the transponder on code 7600 and follow radio failure procedures.

6.4.6 When a Remotely Piloted Aircraft System (RPAS) experiences a lost link between the Remote Pilot (RP) and the Remotely Piloted Aircraft (RPA), the SSR code to be selected or automatically enabled is 7400.

### 6.5 ADS-B Emergency Codes

6.5.1 Due to the ADS-B emergency processing limitations, if a generic ADS-B emergency indication is received from an aircraft outside of RADAR coverage and the flight crew does not verbally communicate the nature of the emergency, the controller will use the procedures detailed in ENR 1.6 para 7.4.2 a.

## 7. AIRCRAFT TRANSPONDER

### 7.1 Operation of SSR Transponders

7.1.1 Except as indicated below, ATS will assign a temporary discrete code for each flight sector for aircraft operating in controlled airspace, and for aircraft participating in Surveillance Information Service (SIS).

7.1.2 Unless advised otherwise by ATC, pilots of Mode 3A or Mode S transponder-equipped aircraft operating in Australian airspace must activate their transponders, and where a Mode C capability is also available it must be activated simultaneously with Mode 3A.

*Note: Pilots must ensure that transponders and ADS-B transmitters are activated and the altitude function is selected as:*

- a. primary RADAR coverage only exists within 50NM of major airports and the remainder of the ATS surveillance system relies on SSR transponder and ADS-B transmitter information, and
- b. TCAS relies on transponder information for its pilot alerting and collision avoidance functions.

7.1.3 Consistent with ICAO Regional (Asia & Pacific - APAC) SSR code management code continuity objectives, Australia's ATM system has been configured to maximise retention of the discrete code assigned on departure to international flights inbound to, or over flying, Australia. This retention normally relies on code assignment notified via the DEP message, and is principally enabled for departures from other APAC Region States. When a departure or other code assigned to a flight cannot be retained in Australian airspace, pilots will be assigned a new SSR code. ATC procedures may also require that pilots be asked to squawk the code being retained.

7.1.4 When operating in Australian airspace, or on reaching the Australian FIR boundary if inbound to Australia, pilots of Mode 3A transponder-equipped aircraft must squawk the assigned temporary discrete code for that flight sector, or if not assigned a temporary discrete code, the appropriate non-discrete code from the following listing, unless advised otherwise by ATS:

- a. Civil flights in classes A, C and D airspace, or IFR flights in Class E airspace 3000
- b. Civil IFR flights in Class G airspace 2000
- c. Civil VFR flights in classes E or G airspace 1200
- d. Military flights in classes A, C, D or E airspace 5000
- e. Military flights in Class G airspace 6000
- f. Civil flights in Class G over water at a distance greater than 15NM from shore. 4000
- g. Civil flights engaged in littoral surveillance 7615
- h. Ground testing by aircraft maintenance staff 2100
- i. Flights operating at aerodromes (in lieu of a, b, or c. when assigned by ATC) 0100
- j. RPAS in all classes of airspace and when instructed to enable transponder 7000

7.1.5 Pilots of flights that will require a SIS and/or a clearance into controlled airspace, and for which a discrete code has already been coordinated, must select that code immediately prior to making their SIS/clearance request.

7.1.6 A pilot must not operate the identification function (SPI) unless requested by ATC.

7.1.7 Flights assigned a temporary discrete SSR code by ATS must squawk that code until termination of the flight sector, unless advised otherwise by ATS. If not assigned a discrete code, the appropriate generic code must be used.

7.1.8 A pilot operating a Mode 3A/C transponder at a radar controlled aerodrome must:

- a. on departure, leave the transponder selected to STANDBY until entering the departure runway; and
- b. on arrival, select the transponder to STANDBY or OFF as soon as practicable after landing.

7.1.9 A pilot operating a Mode S transponder must:

- a. Enter the aircraft's identification that corresponds exactly to the Aircraft Identification shown in Item 7 of the flight notification filed with air traffic control for the flight; for those aircraft that are capable of reporting Aircraft Identification. The ICAO defined format for entry of the Aircraft Identification shall be used except for domestic operations when VH is not to be entered on the flight notification. (e.g. VOZ123D, REX638, QFA842, VHQFO (international), FDA...)
- b. On receipt of ATC clearance, or requesting the earlier of Push Back or Taxi, select TA/RA/XPDR/ON AUTO as applicable.

*Note 1: If AUTO mode is not available Select ON (e.g. XPDR) and assigned Mode A code.*

*Note 2: Australia does not require TA/RA to be de-selected while aircraft is on ground.*

- c. When parked and shutting down engines, select STANDBY.
- d. For Mode S equipped aircraft taxiing without flight plan, the appropriate Mode A code according to paragraph 7.1.4 should be selected and the aircraft identification entered exactly as the call-sign used in flight.

7.1.10 Pilots must select the transponder to STANDBY before effecting an SSR code change and then return the transponder to ON/ALT.

*Note: This action is required to prevent possible loss of displayed aircraft position/label information and possible misidentification of aircraft in automated Australian ATC systems due to temporary selection (while affecting the change) of a code already in use.*

7.1.11 When acknowledging code setting instructions or changes to settings, the pilot must readback the code to be set.

7.1.12 This paragraph from Airservices Australia AIP not applicable to ADF.

7.1.13 Unless instructed otherwise by ATS, pilots of military international flights are required to set code 5000 before departure from an Australian airport.

## 8. ADF - ATS SURVEILLANCE SYSTEM CLOUD BREAK PROCEDURE

### 8.1 Procedures for Military Aircraft

8.1.1 Military aircraft within 10 NM of the aerodrome may be assigned an altitude not more than 500 FT below the minimum altitude assignable for that applicable sector on the RADAR terrain clearance chart (e.g. 1,500 FT can be assigned in a 2,000 FT sector), provided that:

- a. in any case, the minimum altitude assignable shall not be below the highest prescribed circling minimum for the aerodrome;
- b. the reported cloud base in the applicable sector is at least 300 FT above the assignable altitude; e.g. In a 2,000 FT sector where descent to 1,500 FT is permissible, the reported cloud base must be at or above 1,800 FT;
- c. visual flight shall be certain at or above the altitude assigned; and
- d. the aircraft shall be on a RADAR heading which will cause it to pass within 3 NM of the aerodrome.

8.1.2 The altitude assigned to aircraft between 10 NM and 4 NM RADAR range from the aerodrome shall not be more than 500 FT below the minimum altitude for the applicable sector on the RADAR terrain clearance chart (e.g. 1,500 FT can be assigned in a 2,000 FT sector), and in any case shall not be below the highest prescribed circling minima for the aerodrome.

### 8.2 When Procedures Shall Not be Used

8.2.1 RADAR cloud break procedures shall not be used:

- a. on tracks for which a DME arrival procedure is prescribed;
- b. to runways served by an instrument approach aid providing a straight-in approach procedure.



## ENR 1.7 ALTIMETER SETTING PROCEDURES

### 1. PRE-FLIGHT ALTIMETER CHECK

#### 1.1 General

1.1.1 Whenever an accurate QNH is available and the aircraft is at a known elevation, pilots must conduct an accuracy check of the aircraft altimeter(s) at some point prior to take-off.

*Note: Where the first check indicates that an altimeter is unserviceable, the pilot is permitted to conduct a further check at another location on the same airfield; for example, the first on the tarmac and the second at the runway threshold (to determine altimeter serviceability).*

#### 1.2 IFR Altimeters

1.2.1 With an accurate QNH set the altimeter(s) should read the nominated elevation to within 60FT. If an altimeter has an error in excess of  $\pm 75$ FT the altimeter is to be considered unserviceable.

1.2.2 When two altimeters are required for the category of operation, one of the altimeters must read the nominated elevation to within 60FT. When the remaining altimeter has an error between 60FT and 75FT, flight under the IFR to the first point of landing, where the accuracy of the altimeter can be re-checked, is approved. In the event that the altimeter shows an error in excess of 60FT on the second check, the altimeter must be considered unserviceable for flight under the IFR.

1.2.3 An aircraft fitted with two altimeters but requiring only one for the category of operation may continue to operate under the IFR provided one altimeter reads the nominated elevation to within 60FT. Should the remaining altimeter have an error in excess of 75FT that altimeter must be placarded unserviceable.

1.2.4 When an aircraft is fitted with only one altimeter and that altimeter has an error between 60FT and 75FT, flight under the IFR to the first point of landing, where the accuracy of the altimeter can be re-checked, is approved. In the event that the altimeter shows an error in excess of 60FT on the second check the altimeter is to be considered unserviceable for flight under the IFR.

#### 1.3 VFR Altimeters

1.3.1 With an accurate QNH set, a VFR altimeter(s) should read site elevation to within 100FT (110FT at test sites above 3,300FT) to be accepted as serviceable by the pilot. If an aircraft fitted with two VFR altimeters continues to fly with one altimeter reading 100FT (110FT) or more in error, the faulty altimeter must be placarded unserviceable.

1.3.2 VFR altimeters are not permitted for aeroplane operations above FL200. VFR flights operating above FL200 must be equipped with an altimeter calibrated to IFR standards.

#### 1.4 Accurate QNH and Site Elevation

1.4.1 A QNH can be considered accurate only if it is provided by one of the following:

- a. AAIS;
- b. ATC;
- c. ATIS;
- d. AWIS;
- e. CA/GRS; or
- f. WATIR

*Note: QNH contained in an authorised weather forecast must not be used for checking the accuracy of a pressure altitude system.*

1.4.2 **ADF** - Site elevation must be derived from aerodrome survey data that is published by AIS-AF, authorised in writing by either CASA or an NAA, or supplied in writing by the relevant aerodrome operator.

**2. BASIC ALTIMETER SETTING PROCEDURES**

**2.1 Transition Altitude, Transition Layer and Transition Level**

2.1.1 The transition altitude in all Australian FIR is 10,000FT.

2.1.2 The system of altimetry in Australia provides a transition layer of at least 1,000FT between the transition altitude and the transition level. This means the transition level varies from FL110 to FL130 depending on QNH (see Figure 1).

Figure 1 - Altimeter Settings

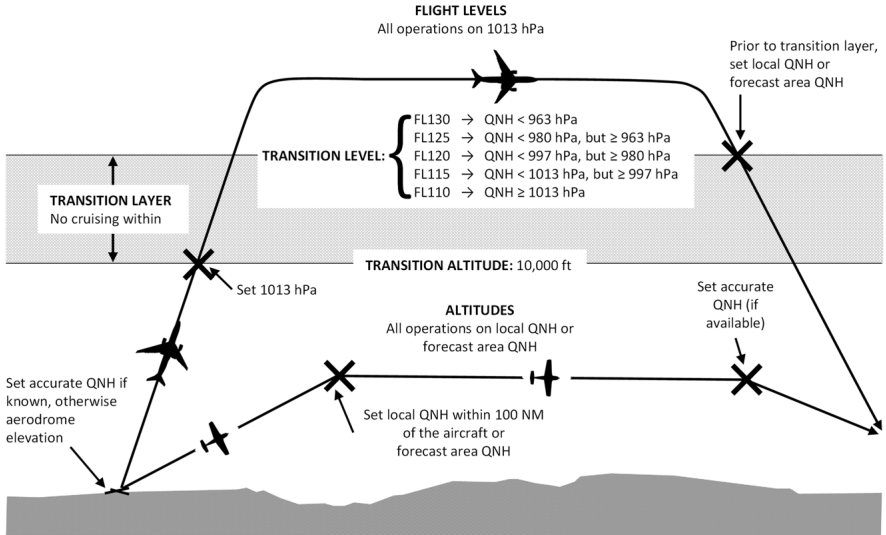

2.1.3 Cruising within the transition layer is not permitted.

2.1.4 For an operation at or below the transition altitude, the altimeter setting must be:

- the current local QNH (either an accurate QNH or forecast QNH) of a station along the route within 100NM of the aircraft; or
- the current forecast Area QNH.

*Note: QNH is available from a reporting station (AAIS, ATIS, AWIS, CA/GRS or WATIR), a TAF, the Area QNH forecast, or from ATS (ATC or FIS).*

2.1.5 For an operation above the transition altitude, the altimeter setting must be 1013.2 hPa.

2.1.6 On climb, the altimeter setting must be changed from QNH to 1013.2 hPa after passing 10,000FT and before levelling off.

2.1.7 On descent, and just before passing the transition layer, the altimeter setting must be changed from 1013.2 hPa to the relevant altimeter setting stated in para 2.1.4.

**2.2 Area QNH.**

2.2.1 Area QNH is a forecast value which is valid for a period of 3HR and normally applies throughout an Area QNH Zone (AQZ).

2.2.2 Area QNH Zones will be subdivided, if necessary, to meet the following standards of accuracy:

- a. Area QNH forecasts are to be within  $\pm 5$  hPa of the actual QNH at any low-level point (below 1,000FT AMSL) within or on, the boundary of the appropriate area during the period of validity of the forecasts.
- b. Area QNH must not differ from an adjoining Area QNH by more than 5 hPa.

2.3 **ADF - Special Procedures for Military CTA.** In military control zones and training areas, local flights operating at or below the transition altitude shall normally remain on terminal QNH, but ATC may authorise the use of other settings in accordance with the following instructions:

- a. Flights departing military CTA and intending to cruise at or below the transition altitude shall, after transfer of responsibility, be notified of Area QNH by the relevant civil or military ATS. Area QNH must be made available before departure to a flight intending to proceed NOCOM before the airspace boundary.
- b. Arriving flights cruising at or below the transition altitude shall be notified of terminal QNH on first descent assignment, unless the aircraft captain indicates receipt of the ATIS.
- c. Overflying aircraft operating at or below the transition altitude in military airspace shall normally remain on Area QNH, but may be requested to set terminal QNH (these settings are considered to be equivalent for separation purposes) by the military ATS.

### 3. CRUISING LEVELS

#### 3.1 Selection of Levels

3.1.1 Flights must be planned in accordance with levels selected from the tables at [Section 5](#). Any part of a flight that will take place south of 80°S must be planned in accordance with levels selected from the tables at [Section 6](#).

3.1.2 Within controlled airspace, ATC may assign and pilots may request a level that does not accord with the tables in [Section 5](#).

3.1.2.1 Pilots must only request a level not conforming to the table of cruising levels when it is determined by the aircraft captain to be essential to the safety of the flight and its occupants. In such circumstances, the phrase 'DUE OPERATIONAL REQUIREMENT' must be included with the level change request.

3.1.3 ATC will only assign cruising levels not conforming to these tables when traffic or other operational circumstances require.

3.1.4 Subject to ATC instructions, a VFR flight must be flown at a cruising level appropriate to its magnetic track according to [Section 5, Table B](#) or [Section 6, Table B](#):

- a. whenever the flight is conducted at a height of 3,000FT AMSL or more; or
- b. ADF - if the flight is conducted at a height of less than 3,000FT AMSL or less than 1,500FT AGL whenever practicable.

3.1.5 An IFR flight must be flown:

- a. within controlled airspace at a cruising level authorised for the flight by ATC; or
- b. ADF - outside controlled airspace at a cruising level appropriate to its magnetic track according to [Section 5, Table A](#) or [Section 6, Table A](#) whenever practicable.

3.1.6 When an IFR flight operating outside controlled airspace is unable to comply with the Table of Cruising Levels, the pilot must:

- a. notify the appropriate ATS unit of the intended change in operating level, and any subsequent changes; and
- b. ADF - in the event of conflict with another aircraft complying with the Table of Cruising Levels, give way to that aircraft or assume a cruising level in accordance with the Table of Cruising Levels until the aircraft with which it is in conflict is past and clear.

*Note: At pilot request, ATC may assign to aircraft a level for cruise within a control area which does not provide the prescribed separation from the lower or upper limit of the control area.*

### 3.2 Block Levels

3.2.1 On request from the pilot, a flight may be cleared to operate within controlled airspace within a Block Level provided that other aircraft are not denied the use of that airspace contained within that block.

3.2.2 Civil IFR flights will not be allocated block levels in Class E airspace.

3.2.3 The pilot shall have complete freedom to change levels within the block, provided that the upper and lower limits are not exceeded. However, a clearance to operate within a Block Level shall be cancelled or amended if another aircraft requests the use of a level within the block.

3.2.4 When cancelling or amending a Block Level clearance, the aircraft operating in a Block Level shall be instructed to climb or descend to an appropriate level or block level in order to provide vertical separation from the other aircraft requesting one of the levels.

3.2.5 Aircraft at standard flight levels will be afforded priority over aircraft using non-standard flight levels.

3.2.6 Mach number technique separation will not be applied to aircraft using block level clearances.

3.2.7 Aircraft operating within a block level must report the upper and lower block levels in all positions and frequency change reports.

*Note: As most altitude alerting systems do not provide protection for both upper and lower assigned levels, flight crews are reminded to be vigilant in monitoring the aircraft altitude when operating within a Block Level.*

### 3.3 ADF - Assignment of Levels to Military Formations

3.3.1 When military formation flights have planned to operate within controlled airspace, in weather conditions which indicate the possibility of a formation break being required, the military authority shall be responsible for making suitable pre-flight arrangements with ATS to ensure that the required formation break procedure can be employed without compromising the safety of other traffic within controlled airspace.

3.3.2 When an airspace reservation is inappropriate, these arrangements will normally require the assignment of a suitable band of levels to the military formation.

## 4. CHANGE OF LEVELS

### 4.1 ATC Approval Required

4.1.1 The aircraft captain must commence a change of level as soon as possible, but not later than 1MIN after receiving that instruction from ATC, unless that instruction specifies a later time or place.

4.1.2 ATC may require that an assigned level must be reached by a specific time, distance or place. If an aircraft captain doubts that the restriction can be met, ATC must be advised immediately.

4.1.3 ATS advised expectation of a level restriction does not authorise a pilot to climb or descend to meet that restriction.

4.1.4 An expectation of a level restriction is not required to be readback.

4.1.5 A requirement to report at a time or place given in the same clearance as a descent/climb instruction does not require the new level to be reached by the specified time or place.

4.1.6 The aircraft captain of an aircraft, receiving an instruction from ATC to change level, must report:

- a. when the aircraft has left a level at which level flight has been conducted in the course of climb, cruise or descent; and
- b. when the aircraft leaves a level for which ATC has requested a report.

4.1.7 During a change of level, the aircraft captain must advise ATC if they maintain an unassigned interim level.

4.1.8 ATC may provide vertical separation between two climbing aircraft, not otherwise separated, by means of a step-climb. Aircraft captains, subject to a step-climb, must adopt the following procedure:

- a. The aircraft captain of the lower aircraft shall report approaching each assigned level in the sequence.
- b. The aircraft captain of the higher aircraft, on hearing the lower aircraft report approaching each assigned level, must report the last vacated level.

4.1.9 Step-descents reverse the above [paragraph 4.1.7](#) procedure.

4.1.10 ATC may specify a rate of climb or descent. Other considerations are as follows:

- a. The phrase "STANDARD RATE", when included in a clearance, specifies a rate of climb or descent of not less than 500FT per minute, except that the last 1,000FT to an assigned level shall be made at 500FT per minute.
- b. In the case of a step-climb or descent, the specified rate will be applicable to all level clearances issued in the course of the step-climb or descent. If unable to comply with the prescribed rate, the aircraft captain must advise ATC.

4.1.11 Cruise Climb is not used in an Australian administered airspace. Where possible, block level clearances will be issued upon request.

**4.2 ATC Approval Not Required**

4.2.1 In airspace where ATC approval is not required to change level, the pilot of an IFR flight must report present position and intention to ATC approximately one (1) minute prior to making any change.

**5. TABLES OF CRUISING LEVELS (NORTH OF 80°S)**

<b>TABLE A - IFR</b>				
<b>Magnetic Tracks</b>	<b>000° - East - 179°</b>		<b>180° - West - 359°</b>	
Cruising Altitudes (Area QNH)	3,000 5,000	7,000 9,000	2,000 4,000 6,000	8,000 10,000
Cruising Flight Levels (1013HPA)	110* 130 150 170 190 210 230 250 270	290 310 330 350 370 390 410 450 490	120* 140 160 180 200 220 240 260 280	300 320 340 360 380 400 430 470 510
<i>Note: *FL110 is not available for level flight when the Area QNH is less than 1013HPA.</i>				
<i>Note: *FL120 is not available for level flight when the Area QNH is less than 980HPA.</i>				
<b>TABLE B - VFR</b>				
<b>Magnetic Tracks</b>	<b>000° - East - 179°</b>		<b>180° - West - 359°</b>	
Cruising Altitudes (Area QNH)	1,500 3,500 5,500	7,500 9,500	2,500 4,500 6,500	8,500
Cruising Flight Levels (1013HPA)	115* 135 155 175	195 215 235	125* 145 165 185	205 225 245
<i>Note: *FL115 is not available for level flight when the Area QNH is less than 997HPA.</i>				
<i>Note: *FL125 is not available for level flight when the Area QNH is less than 963HPA.</i>				

Note 1: Pilots should be aware that VFR aircraft outside controlled airspace may be operating at random levels below 3,000FT AMSL (see [paragraph 3.1.4](#)).

6. TABLES OF CRUISING LEVELS (SOUTH OF 80°S)

TABLE A - IFR				
Grid Tracks	000° - East - 179°		180° - West - 359°	
Cruising Altitudes (Area QNH)	3,000 5,000	7,000 9,000	2,000 4,000 6,000	8,000 10,000
Cruising Flight Levels (1013HPA)	110* 130 150 170 190 210 230	250 270 290 330 370 410 etc.	120* 140 160 180 200 220 240	260 280 310 350 390 430 etc.
<p>Note: *FL110 is not available for level flight when the Area QNH is less than 1013HPA.</p> <p>Note: *FL120 is not available for level flight when the Area QNH is less than 980HPA.</p>				
TABLE B - VFR				
Grid Tracks	000° - East - 179°		180° - West - 359°	
Cruising Altitudes (Area QNH)	1,500 3,500 5,500	7,500 9,500	2,500 4,500 6,500	8,500
Cruising Flight Levels (1013HPA)	115* 135 155 175 195 215 235	255 275 300 340 380 420 460	125* 145 165 185 205 225 245	265 285 320 360 400 440 480
<p>Note: *FL115 is not available for level flight when the Area QNH is less than 997HPA.</p> <p>Note: *FL125 is not available for level flight when the Area QNH is less than 963HPA.</p>				

ENR 1.7

**ENR 1.8 REGIONAL SUPPLEMENTARY PROCEDURES**

1. There are no notifiable regional supplementary procedures applicable to Australia.





**ENR 1.9 AIR TRAFFIC FLOW MANAGEMENT**

**1. FLOW MANAGEMENT STAGES**

1.1 At major airports within Australia, Air Traffic Flow Management procedures are applied to manage demand and capacity at specific airports. These procedures are defined in 3 stages:

- a. **Strategic** - Generally occurs more than one day prior to the day of operation. This is known as schedule coordination and is managed by the specific airport operator, who may use an independent coordinator to manage the scheme.
- b. **Pre tactical** - Occurs on the day prior to operation through the implementation of traffic management initiatives such as a Ground Delay Program (GDP). Airservices Australia National Operations Management Centre (NOMC) manages this service.
- c. **Tactical** - Occurs on the day of operation and uses real time traffic information to sequence traffic to the destination airport. ATC manage this service.

1.2 Tactical flow management takes precedence over pre-tactical air traffic flow management which in turn takes precedence over strategic air traffic flow management.

**2. STRATEGIC - SCHEDULE COORDINATION**

2.1 An airline has the responsibility to obtain permission to operate services from the airport owner and/or operator.

2.2 In addition, all aircraft operators (excluding emergency and state aircraft) must obtain time-slots (slots) in advance of the operation from Airport Coordination Australia (ACA) in accordance with the following table:

Airport	Type of Operation
Sydney, Brisbane and Perth	All arrivals and departures
Adelaide and Darwin	All international and scheduled domestic flights
Cairns, Gold Coast and Melbourne	All international flights

2.3 ACA slots may be obtained from ACA MON-FRI 2200-0600 UTC as follows:

☎: +61 2 9313 5469

E-mail: [slots@airportcoordination.org](mailto:slots@airportcoordination.org)

Web: [www.airportcoordination.org](http://www.airportcoordination.org)

✉ PO Box 3047, Sydney International Airport, NSW 2020 AUSTRALIA, or

Calling at the office: Level 3, Suite 1297, International Terminal, Sydney Airport.

2.4 Notification of changes to slots allocated to existing scheduled flights should be advised to ACA in accordance with the requirements of the appropriate traffic management scheme.

2.5 ACA slots may be obtained outside ACA office hours for short notice non-scheduled flights from the NOMC on 1800 020 626. These slots will be allocated from the available pool.

2.6 Allocated ACA slots may be subject to change by ATFM due to operational constraints.

**3. PRE TACTICAL – GROUND DELAY PROGRAM**

**3.1 General**

3.1.1 The NOMC publishes GDP for:

- a. arrivals to Sydney, Brisbane, Melbourne and Perth Airports; and
- b. departures from Perth Airport.

*Note: Additional operating procedures are contained in ERSA FAC for the specified airport.*

3.1.2 Unless instructed by ATC, pilots should maintain normal or specified climb, cruise and descent profiles.

### 3.2 Calculated Off Blocks Time (COBT)

3.2.1 Pilots must obtain an Air Traffic Flow Management Calculated Off Blocks Time (COBT) for operations at a GDP airport. Pilots of scheduled flights will be advised of their COBT through their operator. Other flights may obtain a COBT through the NOMC by email: [atfmu@airservicesaustralia.com](mailto:atfmu@airservicesaustralia.com) or Ph: 1800 020 626 H24 (recorded line).

3.2.2 Failure to obtain a COBT and/or submit a flight plan for a flight to a GDP program airport will result in the flight being considered early non-compliant.

3.2.3 Unless afforded priority in accordance with ENR 1.4 paragraph 6.1, all aircraft are required to operate within the compliance window for their allocated COBT. Aircraft unable to operate within the compliance window are to obtain a new COBT through their operator or the NOMC (as per *para* 3.2.1). ATC are not able to provide new or amended COBT.

Type of COBT	COBT compliance window
Arrivals (SY, BN, ML, PH)	-5MIN to +15MIN
Departure (PH)	-5MIN to +10MIN

3.2.4 For early non-compliant flights, ATC will only issue a clearance to push back or taxi for a significant ground-based operational requirement or if there is a reasonable expectation that, due to taxi or runway-holding position delays, the required CTOT will be achieved.

3.2.5 If a new COBT has been issued after receiving airways clearance, pilots are to advise ATC of the amended COBT when calling for a start/pushback/taxi clearance.

3.2.6 Notwithstanding actions taken under 3.2.3 and 3.2.4 to achieve compliance, flights departing non-compliant can expect delays en route. Non-compliant flights will be allocated the next available slot time up to a maximum delay as follows:

- a. Early non-compliant - 60MIN; or
- b. Late non-compliant - published traffic holding delay.

### 3.3 Non-scheduled flights

3.3.1 Prior to submitting a flight plan, pilots of non-scheduled flights intending to operate into a GDP airport during the hours of program operation:

- a. should, if required, obtain an ACA slot from ACA prior to contacting the NOMC; and
- b. must contact the NOMC for a COBT and, if unable to obtain prior, an ACA slot.

3.3.2 Where possible pilots should contact the NOMC prior to 0800 UTC the day before to ensure their flight is included in the GDP run for the following day. Operators who contact the NOMC after the GDP have been run will be allocated the next available COBT.

3.3.3 Pilots must provide the following information to the NOMC at least one hour prior to the proposed operation. Any changes must be notified to the NOMC prior to departure.

- a. Aircraft call sign
- b. Aircraft registration
- c. Aircraft type
- d. Departure aerodrome
- e. Destination aerodrome
- f. ETD (UTC time only)
- g. ETA (UTC time only)
- h. COBT notification email/mobile phone number

3.3.4 Notification of flight details to the NOMC is additional to all existing flight plan notification requirements.

- 3.3.5 Pilots of non-scheduled flights must check their COBT for any amendments prior to flight by:
- a. being able to receive a message from the NOMC via their mobile phone/email; or
  - b. contacting the NOMC within one hour of the flight; or
  - c. where no communication facilities are available, contacting the appropriate HF frequency.

**3.4 GDP Run Times**

3.4.1 GDP for the following day's operations are normally run at the following times:

Location	Time (UTC)
Perth (Departures Only)	0815
Perth (Arrivals Only)	0845
Melbourne	0915
Brisbane	1000
Sydney	1100
Sydney (Revision and is optional)	1800 (1700 during HDS)

**3.5 GDP revision**

3.5.1 When unforeseen circumstances significantly reduce the capacity of an airport, a GDP revision may be initiated and pilots must obtain a new COBT. Tower ATC may stop departures to the GDP airport to facilitate the revision.

3.5.2 There are three levels of revision:

- a. Level 1 – compliance with the new COBT will commence in 30min; or
- b. Level 2 – immediate compliance with the new COBT should be observed, however flights that have already manoeuvred to depart may continue; or
- c. Level 3 – immediate compliance with the new COBT should be observed by all flights.

*Note: Level 2 and 3 revisions will not be applied to flights departing Perth, Darwin, Karratha, Port Hedland or Broome, for Brisbane, Sydney or Melbourne.*

3.5.3 The NOMC will advise pilots and operators when a revision occurs. This advice may be provided through ATS when required. When a Level 2 or 3 GDP revision occurs, ATS will advise pilots subject to immediate compliance.

**4. TACTICAL**

**4.1 Aircraft Sequencing Near ATFM Airports**

4.1.1 Due to terminal area traffic density, pilots may expect airborne traffic delays for arrival at locations adjacent to or within Class C control zones.

4.1.2 When sequencing arriving aircraft to controlled aerodromes, ATC may apply one or more of the following:

- a. Enroute holding procedures;
- b. Allocate a waypoint crossing time to the pilot; or
- c. Tactically apply delaying action such as speed control or vectoring.

4.1.3 When ATC allocates a waypoint crossing time, aircraft must adjust speed to cross the waypoint at the specified time or up to 30 seconds early. Speed adjustment to meet a waypoint crossing time only applies to the specified waypoint. Unless otherwise published or instructed by ATC, pilots must cross the waypoint at the lesser of 250KT or profile speed.

4.1.4 Aircraft unable to meet the waypoint crossing time must inform ATC as early as possible.



## ENR 1.10 FLIGHT PLANNING

### 1. FLIGHT PLAN PREPARATION

1.1 Before beginning a flight, an aircraft captain must study all available information appropriate to the intended operation, and must make a careful study of:

- a. current weather reports and forecasts for the route to be flown and the aerodromes to be used;
- b. the airways facilities available on the route to be flown and the condition of those facilities;
- c. the condition of aerodromes to be used and their suitability for the aircraft to be used; and
- d. the Air Traffic Control rules and procedures appertaining to the particular flight.
- e. all Head Office and FIR NOTAM applicable to the en route phase of flight, and location-specific NOTAM for aerodromes.

The pilot must then plan the flight in relation to the information obtained.

*Note: Full details on the services provided by the briefing office are available through the Preflight Information and Flight Planning Manual, available online:*

[www.airservicesaustralia.com/aip/aip.asp](http://www.airservicesaustralia.com/aip/aip.asp) and  
[www.airservicesaustralia.com/industry-info/flight-briefing/](http://www.airservicesaustralia.com/industry-info/flight-briefing/)

### 1.2 Forecasts

1.2.1 Forecast information must include:

- a. an aerodrome forecast for the:
  - 1) departure;
  - 2) destination; and
  - 3) when required, alternate aerodrome; and
- b. one of the following:
  - 1) a flight forecast; or
  - 2) a GAF (at and below A100); or
  - 3) a SIGWX forecast (above A100); and
- c. a wind and temperature forecast

For a flight to a destination for which a prescribed instrument approach procedure does not exist, the minimum requirement is a GAF.

*Note: A wind and temperature forecast may be obtained from Wind and Temperature Charts, Grid Point Wind and Temperature Charts, Route Sector Winds and Temperatures Forecasts, a NAIPS Wind and Temperature Profile (applicable for the flight), as well as from approved flight planning systems that derive data from the Bureau of Meteorology or the WAFS.*

1.2.2 ADF - For flights for which a forecast is required and cannot be obtained, the flight is permitted to depart provided the pilot is satisfied that the weather at the departure point will permit the safe return of the flight within 1HR of departure. The flight is permitted to continue provided the authorised weather forecasts for the route, destination and any planned alternate aerodromes, are obtained within 30 minutes after departure.

1.2.3 For flights to a destination for which an aerodrome forecast is required and cannot be obtained, the flight is permitted to depart provided an alternate aerodrome meeting all the requirements specified in ENR 1.1 Section 10.7 is provided.

1.2.4 An aircraft captain must ensure that the forecasts cover the period of the flight and that the aerodrome forecasts for the destination and alternate aerodromes, to be nominated in the flight plan, are valid for a period of not less than 30MIN before and 60MIN after the planned ETA.

1.2.5 When a flight is delayed so that the meteorological and operational information does not cover the period of flight, updates must be obtained as necessary, to allow the flight to be concluded safely.

1.2.6 A series of flights may be included on the one flight plan provided that:

- a. the meteorological forecast will cover all the flights; and
- b. relevant AIS information is available at flight planning.

1.2.7 When preflight briefing is obtained more than 1 hour prior to EOBT, pilots should obtain an update before each departure to ensure that the latest information available can be used for the flight. The update should be obtained by NAIPS pilot access, telephone, or, when this is impracticable, by radio.

### 1.3 GNSS Prediction Analysis - Flight in Oceanic and Remote Areas

1.3.1 A requirement for flight in oceanic and remote areas using GNSS is that an appropriate en route GNSS prediction analysis be conducted prior to each flight. For details see *FIHA ENR 2.2 Section 4*.

## 2. FLIGHT NOTIFICATION

2.1 Flight notification requirements are divided into two specific categories:

- a. those affecting IFR flights; and
- b. those affecting VFR flights.

2.2 IFR flights require the submission of comprehensive flight notification and the transmission of in-flight progress reports at regular intervals. SARWATCH is based primarily on the receipt of these reports by ATS. (See also *GEN 1.5 Section 1*.)

2.3 Pilots of VFR flights nominating a SARTIME to ATS, and those intending to operate in controlled airspace (except for VFR flights in Class E airspace) must submit flight details to ATS.

2.4 The order of preference for pilots to submit a comprehensive flight notification is:

- a. via pilot access to NAIPS (via the Internet);
- b. in writing;
- c. by telephone; or
- d. by radio to ATS.

2.5 Pilots should submit details required for flight in controlled airspace at least 30 minutes before the expected time of entry. Flight details submitted with less than the 30 minutes notification may be subject to delay.

2.6 Pilots submitting SARTIME flight notifications by fax must confirm receipt of the notification with the briefing office. Further Airservices Australia strongly recommends that when any flight notification is submitted by facsimile, the pilot or operator telephones the briefing office before departure to confirm that the facsimile has been received.

2.7 Abbreviated details for operations in controlled airspace may be advised by radio if the flight is to operate locally, or operations will be for a brief duration. However, prior contact with ATC may avoid delays. Pilots may submit details by radio to ATS when associated with a clearance request, or to nominate a SARTIME.

2.8 When submitting flight notification by radio, pilots should be mindful of the need to minimise frequency congestion and transmit only that information required by ATS for the current flight stage. Acceptance is subject to ATS workload and may be delayed.

2.9 Submission of comprehensive travel flight notification by radio is not a preferred method of notification and should not be used when submission by some other means is available. Flight notification by radio for travel flights requiring the submission of comprehensive details will not be accepted at controlled aerodromes.

2.10 Pilots of VFR flights wishing to operate in other than classes C or D airspace, and who wish to nominate a SARTIME, may submit details in the NAIPS SARTIME flight notification format (via the Internet). If submitting the flight notification by facsimile or via telephone, the only form available is the Australian Domestic Flight Notification form.

2.11 Community Service Flights. This paragraph from Airservices Australia AIP not applicable to ADF.

2.12 If a VFR flight is one of the following:

- a. a flight conducting an air transport operation; or
- b. a flight over water that is conducted beyond a distance from land greater than that which would allow the aircraft to reach land with an engine inoperative; or
- c. a flight in a designated remote area; or
- d. a flight at night proceeding beyond 120NM from the aerodrome of departure;

then the aircraft captain must ensure one of the following has occurred:

- e. submission of a flight plan, or
- f. nomination of a SARTIME for arrival, or
- g. leave a flight note with a responsible person.

2.13 VFR flights which are required to, or wish to, use a SARTIME may do so by providing ATS with the following details:

- a. callsign;
- b. aircraft type;
- c. departure point;
- d. route to be flown;
- e. destination;
- f. POB; and
- g. SARTIME.

*Note: Only one SARTIME may be current at any time. To prevent the existence of multiple SARTIMES for aircraft used by more than one pilot, SARTIMES should be nominated immediately before the start of each flight.*

2.14 VFR flights operating on SARTIME are requested to include contact telephone details for the pilot or company at the destination where available.

2.15 VFR flights may operate on reporting schedules in the following circumstances:

- a. flood, fire or famine relief flights;
- b. search and rescue flights;
- c. over-water flights; and
- d. military flights.

2.16 When the pilot of a flight wishes to indicate a variation of SAR requirements, this must be indicated in Item 8 - Flight Rules, amplified in Item 15 by the position at which the change will occur, followed by the new Flight Rules.

2.17 Submission of flight details at least 30 minutes before EOBT is recommended.

2.18 Where notification of flight details, or changes to details, are submitted less than 30 minutes before EOBT, delays will be encountered when an ATC unit requires that the data be programmed into the computerised SSR Code/Call-sign Management System.

2.19 The preferred method to cancel a SARTIME is via telephone to CENSAR on 1800 814 931. When telephone facilities are not available you may use ATS frequencies.

2.20 SARTIMES are managed on a national basis by the central SARTIME management database, CENSAR.

2.21 **ADF** - Both IFR and VFR military flights must provide full flight details with any flight notification.

2.22 Pilots not formally required to submit flight notification are nevertheless encouraged to leave a flight note as defined in GPA GEN.

### 2.23 ADF - Submission of Flight Details

2.23.1 The following types of flights by military aircraft require the submission of flight plans:

- a. All flights planned to take place in or in close proximity to controlled airspace except those originating in a military control zone which will be confined to the local flying training area.
- b. Flights proceeding to another airfield except where the destination is in the same control zone as the airfield of departure.
- c. All flights conducted outside the confines of local training areas.
- d. **ARMY** - All Army flights, except where a flight will remain within the local training area or an exercise area designated by NOTAM and alternative flight following arrangements are made for the flight.

2.23.2 Aircraft captains carrying out flights which do not require the submission of flight plans shall ensure that flight details are notified to ATS. This information may be in the form of:

- a. a flying program;
- b. written details; or
- c. verbal details.

2.23.3 Additional information may be required at some bases, in which case the requirement shall be detailed in local instructions. Flight details submitted to ATS shall be accurate and complete.

## 3. FLIGHT NOTIFICATION/NOTE CONTENTS

### 3.1 Forms

3.1.1 An example of the Australian Domestic Flight Notification (ADFN) form is at [Appendix 1](#). Instructions for completion of the ADFN for both IFR and VFR flights are contained at [Appendix 2](#). In a number of cases, particularly in Item 19, completion is recommended as good practice. If mandatory items are left incomplete, delays may occur.

*Note: The reverse side of the Australian Flight Notification Form contains a "flight log/template" to assist pilots in planning and navigation. It is not intended to be mandatory or prescriptive, and pilots may use any template, or other device, of their choice.*

3.1.2 The flight notification forms are available from the Airservices website: ([www.airservicesaustralia.com/flight-briefing/](http://www.airservicesaustralia.com/flight-briefing/)).

3.1.3 The suggested format for a Flight Note is at *APPENDIX 3*. This form is available from the CASA website: ([www.casa.gov.au](http://www.casa.gov.au))

### 3.2 Flight Rules

3.2.1 Flight rules must be indicated in any flight notification, except for VFR flights operating wholly outside controlled airspace nominating a SARTIME.

3.2.2 Flights which, within a single stage, will be flown under both the IFR and VFR must indicate:

- a. in the Flight Rules section of the flight notification, the flight rules applicable to the first route segment of the flight plan, Y to indicate IFR first followed by one or more changes of flight rules, or Z to indicate VFR first followed by one or more changes of flight rules;
- b. in Field 15 of the flight notification, the position at which the change of flight rules will occur; and
- c. for each subsequent stage, the flight rules applicable to that stage, with a change in Field 15 if applicable.

*Note: The use of Y or Z must not be used to indicate a variation of flight rules between individual stages. Where the flight rules field is left blank on a multistage flight, the previous flight rule will apply.*

### 3.3 PBN Notification

3.3.1 No indication on the flight notification form is required for Visual Navigation or DR Substitute applications of GNSS.

3.3.2 Notification of PBN capabilities requires a combination of entries in Item 10 (Equipment and Capabilities) and Item 18 of the ATS Flight Notification Form. Guidance is provided in [Appendix 2](#) to this section.



### 3.4 Military Flights

3.4.1 Aircraft operating on LJR for any part of a flight must submit flight notification to ATS, regardless of flight rules.

3.4.2 LJR notification is required for flights planned below 5,000FT AGL within Class G airspace for aircraft that:

- a. operate with a TAS above 250KT
- b. have nominated NOCOM for any portion of the flight; or
- c. are unable to meet reporting requirements.

*Note: LJR notification is not required if the MLJ is operating within a danger area established for that purpose.*

3.4.3 Military flights with an LJR component are required to provide EETs for all points nominated in Item 15 of their flight notification to enable ATS units to provide an effective service.

3.4.4 Military flights carrying out specific operations notified in the remarks section of the flight notification form, together with a level at or below 1,000FT will be operating with reference to ground level.

3.4.5 Pilots of military aircraft that are not RVSM-approved, but require priority in the RVSM flight level band for operational reasons, must enter STS/NONRVSM and RMK/MIL SPEC REQ in Item 18.

3.4.6 Formation flights of State aircraft must not insert the letter W in Item 10 of the ICAO flight plan form, regardless of the RVSM approval status of the aircraft concerned.

### 3.5 General

3.5.1 Pilots of flights operating IFR under a Private IFR rating must include this advice when submitting flight notification. Flight procedure Authorisations (FPA) applicable to flight within controlled airspace must also be included.

3.5.2 For flights not operating along an ATS route, reporting points should be provided in Item 15 for locations approximately 30MIN or 200NM apart.

### 3.6 Location Data

3.6.1 Any location abbreviations used should be authorised abbreviations (e.g. published in AIP).

3.6.2 If a common name is entered into NAIPS in lieu of an aerodrome abbreviation or navigational aid/waypoint, the flight notification output will assume that the aircraft is tracking over a navigational aid/waypoint and not the aerodrome; e.g. the location HOLBROOK will translate to HBK, not YHBK.

3.6.3 Some locations with abbreviations may not have fixed positions e.g. HLS associated with a mobile oil platform or ship. These location codes are linked to fixed geographical coordinates in systems and datasets. To ensure correct provision of ATS, in the event a platform is relocated or is in the process of relocating the NOTAM office must be immediately advised. A NOTAM will be issued to suspend use of the 4 letter location code in flight plans. Pilots must then use the "ZZZZ" procedure as specified in AIP ENR 1.10 Appendix 2 [Item 13 - Departure Aerodrome](#) and [Item 16 - Destination Aerodrome and Total Estimated Elapsed Time - Alternate Aerodrome](#).

When the NOTAM office is notified that the mobile oil platform/ship is back in its original position the NOTAM will be cancelled, and use of the four (4) letter location code in flight plans may resume.

3.6.4 Pilots entering geographical coordinates must adhere to the correct format e.g. 2730S15327E.

#### 4. FLIGHT NOTIFICATION AMENDMENT

4.1 When flight notification details have been submitted and amendment is necessary, advise ATS of the following items as soon as possible:

Item	Details	1. All IFR 2. VFR in CTR/CTA	VFR wholly OCTA (SARTIME)
7	Aircraft ident and/or registration	X	X
8	Flight rules to which flight will be operating	X	
10	Serviceability of equipment carried	X	
13	DEP aerodrome and EOBT if the change exceeds 30 minutes	X	X (DEP AD only)
15 16	Route, landing points or alternates	X	X
15	Cruising level	X	
15	Speed and estimated total elapsed time	X	
18	Any change to: STS/ PBN/ NAV/ RMK/ (includes SARTIME)	X	X
19	POB	X	

4.2 If advising ATS of a change of aircraft ident and/or registration, pilots of SARTIME flights must also advise, prior to take-off, that the flight is subject to a SARTIME.

4.3 To assist in managing the airways system, pilots should always warn ATS of any flight notification amendments by utilising appropriate alerting phraseologies; e.g.: "MELBOURNE CENTRE, DELTA MIKE GOLF, IFR FLIGHT PLAN AMENDMENT" or "FLIGHTWATCH, DELTA MIKE GOLF, SARTIME FLIGHT PLAN AMENDMENT".

#### 5. CARRIAGE OF FLIGHT DOCUMENTATION

5.1 ADF - Pilots conducting certain flights (see the relevant rules in *CASR parts 91, 103, 121, 131, 133 and 135* relating to the carriage of documents) are required to carry, and have readily accessible in the aircraft, the latest editions of the aeronautical maps, charts and other aeronautical information and instructions, published:

- a. in AIP, or
- b. in NOTAM, or
- c. authorised aeronautical information by a data service provide, that are relevant to the route to be flown, and any probable diversionary route that may be flown, on that flight; or
- d. for a flight in a foreign country:
  - 1) in the document that in that country is equivalent to the AIP; or
  - 2) by an organisation approved to publish aeronautical information by the national aviation authority of that country.

#### 6. ADF - SARTIME/NOCOM PROCEDURES

6.1 Military aircraft operating on full reporting procedures and at levels or on frequencies that do not permit continuous communication with ground stations shall:

- a. indicate, in the flight notification, the route segment where communication is anticipated to be non-continuous prefixed by the word NOCOM; and
- b. on reaching the reporting point before entering the NOCOM route segment advise the ETA at the next reporting point where communication can be expected to be normal. In addition, a reporting schedule for OPS NORMAL reports may be advised in cases where communication is expected to be resumed before next reporting point is reached.

6.2 A military aircraft operating outside civil controlled airspace and which is unable to comply with full reporting procedures due to inadequate radio communication facilities, or is unable to predict the time or area where communication with ATS will not be continuous, shall nominate a SARTIME. This SARTIME shall not be more than 4HR after ETD or ATD.

**APPENDIX 1. AUSTRALIAN DOMESTIC FLIGHT NOTIFICATION FORM (ADF)**

Australian – Domestic Flight Notification Form

		7. Aircraft Identification										8. Flight Rules				Type of Flight					
												I   V   Y   Z				S   N   G   M					
9. No	Type	10. Equipment										SSR: L E H S I P X C A N									
		N or S										ADS-B: B1 B2 V1 V2 U1 U2									
Wake Turb Cat		And / Or:										ADS-C: D1 G1									
J   H   M   L		M2 M3 O R T U V W X Y Z																			
13. DEP Aerodrome			EOBT		15. Cruising Speed			Level		16. DEST Aerodrome			Total EET		ALTN Aerodrome						
					N M			A F					HR   MIN								
15. Route																					
18.																					
8. I V Y Z	13. DEP Aerodrome			EOBT		15. Cruising Speed			Level		16. DEST Aerodrome			Total EET		ALTN Aerodrome					
						N M			A F					HR   MIN							
	15. Route																				
	18. (Info relevant to Stage 2)																				
8. I V Y Z	13. DEP Aerodrome			EOBT		15. Cruising Speed			Level		16. DEST Aerodrome			Total EET		ALTN Aerodrome					
						N M			A F					HR   MIN							
	15. Route																				
	18. (Info relevant to Stage 3)																				
18. (Information relevant to all stages)																					
DOF/ REG/VH																					
PER/																					
RMK / SARTIME				To ATS Unit				Location				DEST Tel No:									
Date/Time				Arr						ORGN/											
				Dep																	
19. Supplementary Information (optional)																					
ENDURANCE				PERSONS ON BOARD				EMERGENCY RADIO				DINGHIES									
HR		MIN		P/		R/		UHF		VHF		ELT		NUMBER		CAPACITY		COVER		COLOUR	
E/				P/				U		V		E		D/		C					
SURVIVAL EQUIPMENT				JACKETS																	
E/		P/		POLAR		DESERT		MARITIME		JUNGLE		LIGHT		FLUORES		UHF		YHF		VHF	
E/		P/		S/		P		D		M		J		J/		L		F		U	
AIRCRAFT COLOUR AND MARKINGS																					
A/																					
REMARKS																					
N/																					
PILOT-IN-COMMAND				PHONE				MOBILE				EMAIL				COMPANY					
C/																					

PSN	LSALT	FL or ALT	TAS	TR(M)	WIND	HDG (M)	G/S	DIST	ETI	EET	PLN EST	REV EST	ATA ATD

Item	Fuel Calculation	Min	lbs, L or kg	Min	lbs, L or kg
a	Taxi fuel				
b	Trip fuel				
c	Contingency fuel ( ____ % of b)				
d	Alternate fuel				
e	Final reserve fuel				
f	Additional fuel				
g	Holding fuel				
h	Fuel required (a+b+c+d+e+f+g)				
i	Discretionary fuel				
j	Margin fuel				
k	Endurance (h+i+j)				
	From				

Pilot Notes

CALLSIGN:	PHONE NO:	FAX NO:
-----------	-----------	---------

## APPENDIX 2. ATS FLIGHT NOTIFICATION - USER GUIDE

The Australian Domestic Flight Notification Form provides a modified ICAO flight plan form for Australian requirements and to allow entry of multiple stages of flight.

### Item 7 - Aircraft Identification

- Enter** Aircraft registration/flight number. ZZZZ and TBA cannot be accepted.
- Requirements** One callsign per flight notification. For VH registered aircraft conducting a domestic flight (i.e. within Australian FIR), enter the three letters after the prefix only: e.g. for VH-ZFR enter ZFR. For international flights, enter the full registration e.g. VHZFR.
- For flight numbers, and other approved call-signs, enter a mixture of figures and letters that do not exceed seven alphanumeric characters and without hyphens or symbols: e.g. QFA611.
- For unmanned aircraft:
- enter the prefix UX then at least two characters of the aircraft model e.g. UXSCE4.
  - enter the full radiotelephony callsign in Item 18 after RMK/RTF e.g. UNMANNED SCAN EAGLE FOUR
- One call-sign per flight notification.

### Item 8 (a) - Flight Rules

- Circle** I - if the entire flight will be operated under the Instrument Flight Rules (IFR)  
 V - if the entire flight will be operated under the Visual Flight Rules (VFR)  
 Y - if the flight will be operated initially under the IFR followed by one or more changes of flight rules  
 Z - if the flight will be operated initially under the VFR followed by one or more changes of flight rules
- Requirements** If Y or Z is circled, an entry in Item 15 must specify where the change of flight rules will occur: e.g. YBAF VFR.

### Type of Flight

- Circle** S - for scheduled  
 N - for non-scheduled  
 G - for general aviation  
 M - for military  
 X - if other than any of the defined categories above

### Item 9 - Number of Aircraft

- Enter** Number of aircraft where there are more than one, otherwise leave blank.
- Type**
- Enter** Aircraft type. Where more than one aircraft type is included in a formation, enter the type of the lowest performance aircraft. Additional details regarding the formation must be inserted at Item 18.
- Requirements** Use the two to four letter ICAO approved aircraft type abbreviation. For aircraft type abbreviations not approved by ICAO, enter ZZZZ and specify the type of aircraft in Item 18 preceded by TYP/.

### Wake Turbulence Category

- Circle** J - SUPER, to indicate an A388 aircraft type  
 H - HEAVY, for aircraft 136,000KG MTOW or more, except for A388 aircraft type  
 M - MEDIUM, for aircraft between 7,000 and 136,000KG MTOW  
 L - LIGHT, for aircraft 7,000KG MTOW or less.

**Item 10 - Equipment and Capabilities**

- Circle
- Circle to indicate the presence of serviceable equipment that the pilot is qualified to use and where applicable, has authorisations from the State of Registry:
- N - no COM/NAV/Approach Aid equipment for the route to be flown or the equipment is unserviceable.
- S - standard COM/NAV/Approach Aid equipment of VHF/ILS/VOR.
- A - GBAS Landing System
- B - LPV (APV with SBAS)
- C - LORAN C
- D - DME
- E1 - FMC WPR ACARS
- E2 - D-FIS ACARS
- E3 - PDC ACARS
- F - ADF
- G - GNSS
- H - HF RTF
- I - Inertial NAV
- J1 - CPDLC ATN VDL Mode 2
- J2 - CPDLC FANS 1/A HF DL
- J3 - CPDLC FANS 1/A VDL Mode A
- J4 - CPDLC FANS 1/A VDL Mode 2
- J5 - CPDLC FANS 1/A SATCOM (INMARSAT)
- J6 - CPDLC FANS 1/A SATCOM (MTSAT)
- J7 - CPDLC FANS 1/A SATCOM (Iridium)
- K - MLS
- L - ILS
- M1 - ATC SATVOICE (INMARSAT)
- M2 - ATC SATVOICE (MTSAT)
- M3 - ATC SATVOICE (Iridium)
- O - VOR
- P1 - CPDLC RCP 400
- P2 - CPDLC RCP 240
- P3 - SATVOICE RCP 400
- P4-P9 - Reserved for RCP
- R - PBN Approved
- T - TACAN
- U - UHF RTF
- V - VHF RTF
- W - RVSM Approved (except STATE formation flights)
- X - MNPS
- Y - VHF with 8.33 kHz channel spacing capability
- Z - other equipment or capabilities (see note 1).

*Note 1: If the letter Z is used, specify the other equipment carried or other capabilities in [Item 18](#), preceded by COM/, NAV/ and/or DAT/, as appropriate.*

*Note 2: If the letter R is used, specify the performance based navigation levels that can be met in [Item 18](#) following the indicator PBN/.*

*Note 3: The NAIPS interface does not currently support the use of P1, P2 and P3. Operators may only have to declare the RCP capability for flights that will operate in airspace administered by States that require it.*

Enter 'G' (GNSS) and 'R' (PBN capability) in Item 10 for aircraft equipped with a GNSS enabled area navigation system with additional entries as appropriate. The correlation between Item 10 and Item 18 entries for common PBN approvals is summarised below:

	PBN Capability	Item 10:	Item 18:
Oceanic	RNAV10 (RNP10)	GR and I (if appropriate)	PBN/A1
	RNP4	GR	PBN/L1
Continental	RNP2	GZ	NAV/RNP2
Terminal	RNP1, all permitted sensors	GRDI	PBN/O1
	RNP1, GNSS	GR	PBN/O2
Approach	RNP APCH	GR	PBN/S1
	RNP APCH with Baro-VNAV	GR	PBN/S2
	RNP AR APCH with RF	GRI	PBN/T1 <b>D</b>
Precision Approach	GLS	AGZ	NAV/GLS

For the majority of Australian IFR operations the appropriate field 10 navigation entries will be:

- S - Standard COM/NAV/Approach Aid combination of VHF/VOR/ILS; and
- R - PBN capable; and
- G - GNSS; and
- Z - Other equipment or capabilities (required to enable nomination of NAV/RNP2 in [Item 18](#)).

### Surveillance Equipment

Circle N - for Nil, or

#### **Aircraft with ADS-B capability:**

Note:

1. *ADS-B capability indicated in a domestic flight notification is only for a capability suitable for ATC service. ADS-B equipment outputting a Source Integrity Level (SIL) of 1 (SIL=1) (e.g. TABS devices and EC devices) is not suitable for ATC service. Therefore an aircraft fitted with ADS-B equipment outputting SIL=1 should not enter an ADS-B code in Field 10b. See later note about indicating transponder capability.*

2. *Light Sport Aircraft (LSA), experimental aircraft and other eligible aircraft fitted non-TSO ADS-B equipment eligible for and outputting SIL=2 or SIL=3 may indicate a relevant ADS-B code in Field 10b.*

Enter up to two ADS-B codes: either 'L' or 'E' and 'B1' or 'B2'.

L - SSR Transponder Mode S, including aircraft identification, pressure altitude, ADS-B Out and enhanced surveillance capability.

E - SSR Transponder Mode S, including aircraft identification, pressure altitude and ADS-B Out capability.

B1 - ADS-B "Out" capability using 1090MHz extended squitter.

B2 - ADS-B "Out" and "In" capability using 1090MHz extended squitter.

*Note: Enhanced surveillance capability is the ability of the aircraft to downlink aircraft derived data via a Mode S transponder.*



Use the following table to determine the Field 10b entries for ADS-B transponder (use only one entry):

**Mode S transponder with ADS-B**

Field 10b Entry	Transponder Capability					
	Mode S (ADS-B)	Message ID	Pressure Altitude	Enhanced Surveillance	ADS-B 1090 OUT	ADS-B 1090 IN
LB2	X	X	X	X	X	X
EB2	X	X	X		X	X
LB1	X	X	X	X	X	
EB1	X	X	X		X	

**Aircraft without ADS-B capability:**

*Note: Aircraft fitted with a transponder together with a TABS device or EC device outputting SIL=1 should only enter a code in Field 10b appropriate for the transponder fitted to the aircraft.*

Enter one SSR code representing the highest level of non-ADS-B surveillance capability available (in order highest is H then S, I, P, X, C and A is lowest).

- H - SSR Transponder Mode S, including aircraft identification, pressure altitude, and enhanced surveillance capability.
- S - SSR Transponder Mode S, including both pressure altitude and aircraft identification capability.
- I - SSR Transponder Mode S, including aircraft identification, but no pressure altitude capability.
- P - SSR Transponder Mode S, including pressure altitude, but no aircraft identification capability.
- X - SSR Transponder Mode S with neither aircraft identification nor pressure-altitude capability.
- C - SSR Transponder Mode C.
- A - SSR Transponder Mode A.

*Note: Enhanced surveillance capability is the ability of the aircraft to down-link aircraft derived data via a Mode S transponder.*

Use the following table (listed in order of highest to lowest capability) to determine to correct Field 10b entry for non-ADS-B transponder (use only one entry):

**Non-ADS-B Transponder**

Field 10b Entry	Transponder Capability					
	Mode A	Mode C	Mode S (non-ADS-B)	Aircraft ID	Pressure Altitude	Enhanced Surveillance
H			X	X	X	X
S			X	X	X	
I			X	X		
P			X		X	
X			X			
C	X	X			X	
A	X					

**Aircraft with ADS-C capability**

Enter up to two ADS-C codes: 'D1' and/or 'G1'

D1 - ADS-C with FANS 1/A capabilities

G1 - ADS-C with ATN capabilities

*Note: The RSP specification(s), if applicable, will be listed in Item 18 following the indicator SUR/. Operators may only have to declare the RSP capability for flights that will operate in airspace administered by State that require it.*

**Item 13 - Departure Aerodrome****Item 16 - Destination Aerodrome and Total Estimated Elapsed Time - Alternate Aerodrome**

Enter Aerodrome abbreviation in four letters.

Requirements Enter the four letter authorised abbreviation then, without a space, the total estimated elapsed time as four figures in hours and minutes: e.g. 0340. Include any aerial work delay noted as DLE in [Item 18](#). For aerodromes without an authorised abbreviation, enter ZZZZ. In [Item 18](#) write DEP/ (or as applicable "DEST/ALTN/") followed by either the latitude and longitude of the aerodrome or bearing and distance from a location with an authorised abbreviation or, the first point of the route or the marker radio beacon if the aircraft has not taken off from the aerodrome. In [Item 18](#), enter the common name of the alternate location after RMK/.

*Note 1: For bearing and distance, enter the designator of the location followed by three figures in degrees magnetic followed by three figures in nautical miles; e.g. BN270120 is a position 120NM, 270° from Brisbane.*

*Note 2: Use of authorised aerodrome abbreviations for mobile locations may be suspended by NOTAM when not in the normal location. Pilots must use ZZZZ and provide location details when the aerodrome abbreviation is suspended.*

**Total EET**

Enter Total estimated elapsed time of the flight as four figures in hours and minutes: e.g. 0340 and include any aerial work delay noted as DLE in [Item 18](#).

**AFIL**

AFIL (Flight Notification Filed in the Air) can be used instead of the departure aerodrome abbreviation when ATS services are only required for entry to, or to cross controlled airspace. (Estimated Off Blocks Time becomes the estimate for the point where the ATS service is to commence.)

*Note: For a flight plan received from an aircraft in flight, the total estimated elapsed time is the estimated time from the first point of the route to which the flight plan applies to the termination point of the flight plan.*

**Estimated Off Blocks Time**

Enter Estimated off blocks time (EOBT), or the estimate for the point where the ATS service is to commence (applicable for use with AFIL - as referred to above in the departure aerodrome section), in four figure UTC.

Requirements Provide an EOBT for every flight stage as HHMM. All flights must also include DOF/ followed by the date of flight as YYYYMMDD at [Item 18](#), even if the date of flight is the current day. EOBT/DOF more than 120 hours (5 days) in advance of the time of notification cannot be accepted. A change more than 30 minutes to a submitted EOBT should be advised to ATS or through NAIPS.

**Item 15 - Cruising Speed**

Enter Enter TAS in knots or enter Mach number.

Requirements Circle N, then enter zero and three figures for knots: e.g. 0180.  
Circle M, then enter zero and two figures for mach number to the nearest hundredth of a unit: e.g. 082.

**Level**

- Enter First planned cruising level.
- Requirements Enter either "A" followed by three figures to indicate altitude in hundreds of feet up to and including 10,000FT: e.g. A085; or "F" followed by three figures to indicate flight levels above 10,000FT: e.g. F350.

**Item 15 - Route**

- Enter Details of the planned route, change of level, flight rules, and cruise climb.
- Requirements for locations/waypoints
  - For an aerodrome, use authorised abbreviation; e.g. YMBL for Marble Bar. For a navaid identifier, use published two or three letter abbreviation; e.g. CDU for Ceduna NDB.
  - For a latitude and longitude identification, use degrees and minutes in an eleven character group; e.g. 2730S15327E.
  - For a waypoint use assigned designator; e.g. CANTY.
  - For bearing and distance, enter the identification of the significant point followed by three figures in degrees magnetic followed by three figures in nautical miles; e.g. BN270120 is a position 120NM, 270° from Brisbane.

Requirements for route  
 Check AIP charts and DAH for full route details and ERSA Flight Planning Requirements for specific route requirements/restrictions and city pair options. Where specific route requirements/restrictions are not specified, route details may be entered according to the following rules:

- a. Route details must start and end with DCT (direct);
- b. DCT must be followed or preceded by one of the following points:
  - 1) Navaid;
  - 2) Waypoint; or
  - 3) ARP, that is not the departure or destination location (unless a DLE (Delay En Route) is planned at the location).
- c. Subsequent points should be described by ATS route designators where defined.

When planning via an intersection waypoint (black square) to change from one route to another, flight plan via:

- a. the air route to the waypoint short of the intersection waypoint, then
- b. direct to the intersection waypoint, then
- c. direct to the first waypoint on the second air route, then
- d. via the new air route.

Route Flight Planning Examples

ROUTE TYPE	EXAMPLE ENTRY
<b>Flights Outside Designated ATS Routes:</b>	
Direct from departure point to destination without the use of nav aids.	<i>For YAUR - YPMP:</i> DCT
Direct from departure point to destination with the use of nav aids	<i>For YROM - YCMU:</i> DCT ROM CMU DCT
From departure point to destination via published or non-published points	<i>For YBDV - YLRE:</i> DCT BDV BDV062150 LRE DCT or DCT BDV 2440S14147E LRE DCT or DCT BDV YMOO LRE DCT

ROUTE TYPE	EXAMPLE ENTRY
For survey work, include the points where the aircraft will enter and exit the survey area. (See Note 2)	<i>For YGLA - YGLA (via survey area):</i> DCT GLA BUD YGYM 2500S15100E GLA DCT
<b>Flights On Designated ATS Routes:</b>	
To or from locations with or without navigation aids.	<i>For YPAD - YLLE:</i> DCT AD H246 OOM DCT <i>For YSSY - YLHI:</i> DCT TESAT B450 LHI DCT
Via the SID or STAR transition point of the route. (See Note 3)	<i>For YBBN - YSSY:</i> DCT SANEG H91 IGDAM H12 BOREE DCT Where SANEG is the SID transition point from Brisbane and BOREE is the STAR transition point to Sydney <i>For YSSY - YLHI:</i> DCT NOBAR B450 LHI DCT
Changing routes at a waypoint Intersection	L503 IGEVO DCT LEKET DCT VIMAV N759

*Note 1: Pilots should refer to FIHA ENR 1.1 Section 5 "Air Route Specifications" and ENR 1.1 Section 4 "NAVIGATION REQUIREMENTS" when planning a route.*

*Note 2: When planning to conduct survey work, a map of the survey area must be provided to ATS with the flight notification. When planning survey work, include in item 18 the expected delay en-route (DLE) at the commencement of survey; e.g. DLE/YGYM0130 indicates a delay at Gympie for 90 minutes.*

*Note 3: SID/STAR designators and instrument approach fixes/waypoints for Australian airports must not be entered. Designated ATS routes and published location identifiers or waypoints must be used instead.*

#### Requirements for change of speed/level

Enter the significant point at which a change of speed (5% TAS or 0.01Mach or more) or a change of level is planned to commence, followed by an oblique stroke and both the cruise speed and the level without a space between them; e.g. AYE/N0130A080, AS/M082F350. Both cruise speed and level must be entered even when only one of these quantities will be changed.

#### Requirements for change of flight rules

Enter details of a change to flight rules following the entry in Item 8 of Y or Z. Enter the location where the change will occur followed by a space and VFR or IFR: e.g. YBAF VFR. A change in level may also be included; e.g. ROM/N0180A090 IFR.

#### Requirements for cruise climb/block level

Enter the letter C followed by an oblique stroke, the point at which the cruise climb or block level is planned to start, an oblique stroke, the speed to be maintained during the cruise climb or block level, AND the two levels defining the layer to be occupied during the cruise climb or block level, OR one level and the word PLUS; e.g. C/FERET/N0380F370F390, or C/FERET/N0380F370PLUS.

*Note: Cruise Climb is not used in an Australian administered airspace. Level clearances will be issued upon request, subject to availability.*

#### Item 18

Enter Other information such as navaid training, block surveys and other plain language remarks of significance. Whenever possible, limit item 18 to 250 characters or less.

*Note 1: Flight plans with excessive Item 18 data require manual processing to address an ATM system limitation, which may cause delay and an increased risk of processing error.*

*Note 2: ACARS and TCAS or ACAS are not required to be included in the flight notification.*

**Enter information in the sequence shown below:**

**STS/** Use for special aircraft handling, followed by one or more of the indicators below separated by a space e.g. STS/MEDEVAC NONRVSM;  
ALTRV - flight operated in accordance with an altitude reservation;  
ATFMX - flight approved for exemption from ATFM measures by ATC;  
FFR - fire-fighting;  
FLTCK - flight check for calibration of nav aids;  
HAZMAT - flight carrying hazardous material;  
HEAD - flight engaged in, or positioning for, the transport of dignitaries with Head of State status;  
HOSP - medical flight declared by medical authorities;  
HUM - flight operating on a humanitarian mission;  
MARSAS - flight for which a military entity assumes responsibility for separation of military aircraft;  
MEDEVAC - life critical medical emergency evacuation;  
NONRVSM - non RVSM-capable flight intending to operate in RVSM airspace;  
SAR - flight engaged in a search and rescue mission; and  
STATE - for a flight engaged in domestic or international military services; or international customs or police services.

*Note: Other reasons for special handling by ATS may be denoted under the designator RMK/.*

**PBN/** Followed by PBN capabilities. R must have been entered in Item 10. Include as many of the descriptors below, as apply to the flight without space e.g. PBN/A1L1T1. The field capacity is 16 characters only i.e. 8 entries. In order to make efficient use of the available capacity to present relevant aircraft capability use the following guidance:

- Only include one of the RNP APCH entries S1 or S2, not both.
- Only include one of the RNP APCH entries T1 or T2, not both.
- If RNAV 5 and B2, B3, B4 and B5 are applicable use B1, All Sensors. LORAN C (B6) is not required in Australia to qualify for B1.
- If a DME/DME/IRU specification is filed (C4, D4 or O4) do not file DME/DME (C3, D3 or O3) as well

Descriptor	RNAV Specification
A1	RNAV 10 (or RNP 10)
B1	RNAV 5 all permitted sensors (except LORANC)
B2	RNAV 5 GNSS
B3	RNAV 5 DME/DME
B4	RNAV 5 VOR/DME
B5	RNAV 5 INS or IRS
B6	RNAV 5 LORANC
C1	RNAV 2 all permitted sensors
C2	RNAV 2 GNSS
C3	RNAV 2 DME/DME
C4	RNAV 2 DME/DME/IRU

Descriptor	RNAV Specification
D1	RNAV 1 all permitted sensors
D2	RNAV 1 GNSS
D3	RNAV 1 DME/DME
D4	RNAV 1 DME/DME/IRU

Descriptor	RNP Specification
L1	RNP 4
O1	RNP 1 all permitted sensors
O2	RNP 1 GNSS
O3	RNP 1 DME/DME
O4	RNP 1 DME/DME/IRU
S1	RNP APCH
S2	RNP APCH with BARO-VNAV
T1	RNP AR APCH with RF
T2	RNP AR APCH without RF

*Note: RNP2 has not yet been allocated a PBN code. Enter RNP2 in NAV/ with G, R and Z in Field 10.*

- NAV/ Followed by navigation equipment or capabilities other than those listed for Item 10 or under PBN/ e.g. NAV/RNP2. Z must have been entered in Item 10.
- COM/ Followed by communication equipment or capabilities other than those listed for Item 10a. Use when Z has also been entered in Item 10a: e.g. COM/HF3452.
- DAT/ Followed by data communication equipment and capabilities not specified in 10a. Use when Z has also been entered in Item 10a.
- SUR/ Indicate surveillance equipment and capabilities not specified in 10b. Indicate as many RSP specification(s) as apply to the flight, using designator(s) with no space. Multiple RSP specifications are separated by a space. Example: RSP180 RSP400.
- DEP/ When ZZZZ has been entered in Item 13 followed by latitude and longitude or bearing and distance from a location with an authorised abbreviation: e.g. DEP/BN090120.
- DEST/ When ZZZZ has been entered in Item 16 followed by latitude and longitude or bearing and distance from a location with an authorised abbreviation: e.g. DEST/2730S15327E.
- DOF/ Followed by YYMMDD to indicate the date of flight: e.g. DOF/121115
- REG/ Followed by the full aircraft registration: e.g. REG/VHZFR.
- EET/ For international flights that enter or leave the Australian FIR use EET/ to indicate the estimated elapsed time to the FIR boundary. Enter EET/ followed by the FIR boundary indicator and the estimated elapsed time in hours and minutes: e.g. EET/YMMM0130.
- SEL/ Followed by the SELCAL Code, for aircraft so equipped.
- TYP/ When an approved aircraft type designator has not been assigned and ZZZZ has been entered in Item 9, enter TYP/ followed by the aircraft type: e.g. TYP/Echo Mk1.
- CODE/ Aircraft address (optional). Expressed in the form of an alphanumeric code of six hexadecimal characters e.g. CODE/7C0001.

DLE/	followed by the point where the aircraft will be operating and the estimated time in hours and minutes as a four figure group: e.g. DLE/MDG0030 RMK/MDG NDB indicates that the aircraft will be delayed at Mudgee for 30 minutes training on the NDB.
OPR/	Name of the aircraft operating agency, if different from the aircraft identification in item 7.
ORGN/	Followed by the originator's contact details such as a contact phone number when submitting a SARTIME.
PER/	Followed by the aircraft performance category as described in <i>ENR 1.5 sub-section 1.2</i> : e.g. PER/B. IFR aircraft arriving at a controlled aerodrome must insert their performance category.
ALTN/	when ZZZZ has been entered in Item 16 followed by latitude and longitude or bearing and distance from a location with an approved abbreviation: e.g. ALTN/2700S15320E.
RMK/	When any other plain language remarks are required or deemed necessary. Where applicable, followed by one or more of the indicators below: <p><b>SARTIME</b>, followed by FORARR (for arrival) or FORDEP (for departure), date/time as a six figure group, the authority (TO CENSAR) and location as an authorised aerodrome abbreviating, navaid identifier or latitude/longitude. ZZZZ cannot be accepted for the location.</p> <p>Only one SARTIME per flight notification may be entered. If more than one SARTIME is required, then TBA can be entered, e.g.  RMK/SARTIME FOR ARR 080430 TO CENSAR YROM, or  RMK/SARTIME FOR DEP TBA TO CENSAR YBMV.</p> <p>Pilots are also requested to submit contact telephone details under ORGN/ when available.</p> <p><b>ATC APPROVED NIL ADSB</b>, insert if in receipt of an approval issued by Airservices in accordance with <i>GEN 1.5, paragraph 6.2</i>.</p> <p><b>ADSB EXEMPT</b>, if in receipt of an individual CASA exemption or authorisation.</p> <p><b>CSF</b>, if conducting a community service flight as defined in <i>GEN 2.2</i>.</p> <p><b>FLT</b>, insert if flight numbers are used either in RTF phraseologies or for traffic sequencing, and are not entered in Item 7.</p> <p><b>FORM</b>, Insert details of the aircraft taking part in a formation flight if more than one aircraft type or different RVSM approval is included in the formation. The number, type and wake turbulence category and RVSM approval of the second and subsequent types of aircraft are entered, separated by a plus sign: e.g. RMK/FORM 2PC9+4F18 M OPS IN R577, or RMK/FORM 2F18+2F18 W.</p> <p><b>PIFR</b>, insert PIFR as the first element of RMK/ to indicate that the pilot is rated to Private IFR. Include relevant FPAs applicable to flight within controlled airspace as per the table below:</p>



Flight Procedure Authorisations (FPA)	Abbreviation		Example/Notes
	Prefix	Suffix	
Navigation Only	NAV		Enter equipment as per item 10 and RMK/PIFR NAV in item 18
Night Flying	NGT		RMK/PIFR NGT
Instrument Departures	IDEP	SID	RMK/PIFR IDEP RMK/PIFR IDEP SID
Instrument Approaches (Single or Multi-engine as applicable to the aircraft being flown)	IAL	NDB, VOR, DME, DMEGNSS, RNAVGNSS, ILS, LOC	RMK/PIFR IAL NDB RMK/PIFR IAL DMEGNSS RMK/PIFR IAL RNAVGNSS RMK/PIFR IAL VOR, ILS
Visual Circling Approach	VSA		RMK/PIFR VSA Not required where other IAL FPA are also listed.
STAR	STAR	NDB, VOR, GNSS, DME	RMK/PIFR STAR GNSS
Holding	HLDG	NDB, VOR, GNSS, DME	RMK/PIFR HLDG VOR
Multiple FPA			RMK/PIFR NAV IAL RNAVGNSS HLDG VOR GNSS

**Item 19 - Supplementary Information**

- Enter Additional information relevant to the flight for search and rescue purposes (optional).
- E/ Endurance - Enter a 4-figure group giving fuel endurance in hours and minutes for each stage of flight.
- P/ Person on board - Enter the total number of persons on board (passengers and crew) for each stage of flight. Enter TBN if the total number of persons is not known at the time of filing.
- R/ Emergency radio - Circle the following if carried:  
 U UHF radio on 243.0MHz  
 V VHF radio on 121.5MHz  
 E ELT
- D/ Dinghies - Enter the following:  
 NUMBER Total number of dinghies carried.  
 CAPACITY Total capacity, in persons, of all dinghies.  
 COVER Circle if dinghies are covered.  
 COLOUR Colour of dinghies.
- S/ Survival Equipment - Circle the following if carried  
 P Polar  
 D Desert  
 M Maritime  
 J Jungle  
*Note: See ERSA - EMERGENCY PROCEDURES for further information.*
- J Jackets - Circle if life jackets carried and circle if equipped with the following:  
 L Lights  
 F Fluroscein  
 U UHF radio on 243.0MHz  
 V VHF radio on 121.5MHz
- A/ Aircraft colour and markings is used to record predominate colour and significant markings of the aircraft.

N/ Remarks - Indicate any other survival equipment carried and any other remarks regarding survival equipment.

C/ Aircraft captain - Include telephone, mobile and email address and company name (if applicable).

## Military Supplement

### Item 18

Enter The following list of abbreviations shows those approved for use by the Military. These abbreviations must be used to indicate the type of flying activity to be conducted. No other abbreviations are to be used. All levels specified with these abbreviations indicate operations at or below that level. Levels below 1,000FT are to be treated as AGL.

EET/ All fighter/strike operations must enter EET/ for the LJR component of the flight. EET/ is followed by the designator and the elapsed time in hours and minutes from the departure point to the significant point: e.g. EET/CG0108 2726S15333E0116 BN0120 indicates an elapsed time to Gold Coast of 68 minutes, Point Lookout 76 minutes and Brisbane 80 minutes.

Any en-route delay time (DLE) must be accumulated with the estimated elapsed time associated with the route segment from the airwork position:

e.g. EET/CG0108 2726S15333E0116 BN0140 DLE/2726S15333E0020 indicates an estimated elapsed time to Gold Coast of 68 minutes, Point Lookout 76 minutes and Brisbane 100 minutes (including the 20 minutes airwork).

RMK/ followed by one or more of the indicators below:

**TFR** followed by a level to indicate Terrain Following Radar: e.g. RMK/TFR003.

**LLN** followed by a level to indicate Low Level Navigation: e.g. RMK/LLN010.

**LLO** followed by a level to indicate Low Level Operations: e.g. RMK/LLO030.

**SVY** followed by a level to indicate Aerial Survey: e.g. RMK/SVY050.

**NVG** followed by a level to indicate Night Vision Goggle exercise: e.g. RMK/NVG008.

**AVM** followed by a significant point and upper level of operation to indicate Abrupt Vertical Manoeuvres: e.g. RMK/AVM2515S14330EA090.

**NOCOM** followed by (time after ATD) + (time after ATD) CNL (agency) (frequency), to indicate that communications will be non-continuous for the specified period: e.g. RMK/NOCOM 10+34 CNL WLM APP 135 7, indicates that the aircraft will be NOCOM from 10 minutes after ATD until 34 minutes after ATD and will cancel NOCOM with Williamtown Approach on 135.7 MHZ.

*Note: There may be more than one NOCOM period annotated.*

**MILSPECREQ** To indicate special requirements flights for military aircraft.

Pilots must include the reason for MILSPECREQ in:

a. STS/ for NONRVSM;

b. RMK/ for:

1) LTD COMNAV;

2) LTD FUEL ENDCE;

3) TO LAND BY TIME;

4) AAR MARSAs; or

5) other purpose as decided by the military authority.

**MARSA** followed by the call-sign of the aircraft or formation with whom MARSA will apply e.g. RMK/MARSA PSTL. Use when STS/MARSA has also been entered in Item 18;

**AAR** followed by RVCP or anchor point, track designator or MAAA (as applicable) and MARSA call-sign e.g.  
RMK/AAR AMX100 MARSA BUCK4; or  
RMK/AAR CARBN W946 MARSA COLT.

APPENDIX 3. FLIGHT NOTE

FLIGHT NOTE

The holder of this Flight Note should alert/contact **JRCC Australia on 1800 815 257** if the pilot has not contacted the holder, to confirm their safety, prior to the **Alert Authorities Time** below. Any delay could be crucial to the safety of the occupants of the aircraft.

**Note:** All times are local at each location

<b>Final Destination:</b>	<b>Alert Authorities Time:</b> (Local Time)	<b>Date:</b>
---------------------------	---	--------------

By supplying all available details below, search and rescue will be more efficient, potentially saving lives, time and cost.

<b>Call-sign:</b>	<b>Type:</b>	<b>Aircraft colour/markings:</b>	<b>Nav aids:</b> (Carried & used, include GNSS)	<b>TAS:</b>
<b>Pilot's Name:</b>		<b>Mobile Ph:</b>	<b>Alternative Ph (if any):</b>	
<b>Emergency/Secondary/After Hours Contact</b> (Name/Company/Location/Ph):				

**Note:** Complete a separate line for each flight sector

DEP AD/Point & Ph	EOBT (Local time)	Route (Turning points)	DEST & Ph	POB	Endurance HR   MIN	

**Remarks (if any):** (Other useful information to aid Search and Rescue - Mobile phone number of passengers/registration if different from call-sign)

<b>Emergency Equipment</b> (tick box as appropriate)						
<b>Survival Equipment</b>	Life raft <input type="checkbox"/>		First Aid <input type="checkbox"/>	Water <input type="checkbox"/>	Lifejackets <input type="checkbox"/>	Emergency Rations <input type="checkbox"/>
	Capacity & colour:					
<b>ELT/PLB/EPIRB</b>	Fixed <input type="checkbox"/>	Portable <input type="checkbox"/>	<b>Insert HEX ID/UIN if known:</b>			
<b>Flight monitoring/aircraft tracking</b>		Fitted <input type="checkbox"/>	<b>Type:</b>			Nil <input type="checkbox"/>
<b>Emergency recovery system</b>		Parachute <input type="checkbox"/>	<b>Other:</b>			Nil <input type="checkbox"/>
<b>Other signalling/Life-saving devices</b>						



**ENR 1.11 ADDRESSING OF FLIGHT PLAN MESSAGES**

1. Flight plans are submitted to the briefing office in Canberra, or transmitted directly via NAIPS or the AFTN (see AFTN address list at GPA GEN 3.4, [\(Appendix 1\)](#)).

1.1 Flight movement messages relating to traffic into or via the Brisbane and Melbourne FIRs should be addressed in accordance with the following table:

FIR or Controlled Aerodrome	Message Address
Brisbane FIR	YBBBZQZX
Melbourne FIR	YMMMZQZX
Departure or Destination Aerodrome	[ICAO Location Code] ZTZX (see GEN 3.4 Appendix 1 Aerodrome Location Codes)



**ENR 1.12 INTERCEPTION OF CIVIL AIRCRAFT**

**1. ACTION BY INTERCEPTED AIRCRAFT**

1.1 The following procedures and visual signals apply over the territory and territorial waters of Australia in the event of interception of an aircraft.

1.2 An aircraft which is intercepted by another aircraft must immediately:

- a. follow the instructions given by the intercepting aircraft, interpreting and responding to visual signals in accordance with the table at Section 2 – Visual Signals for Use in the Event of Interception;
- b. notify, if possible, the appropriate ATS unit;
- c. attempt to establish radio communication with the intercepting aircraft, or with the appropriate intercept control unit, by making a general call on the emergency VHF frequency 121.5MHz and repeating this call on the emergency UHF frequency 243.0MHz, if practicable, giving the identity and position of the aircraft and nature of the flight;
- d. if equipped with SSR transponder, select code 7700, unless otherwise instructed by the appropriate ATS unit; and
- e. if equipped with ADS-B or ADS-C, select the appropriate emergency functionality, if available, unless otherwise instructed by the appropriate ATS unit.

1.3 Radio communications during interception

1.3.1 If radio contact is established during interception but communication in a common language is not possible, attempts must be made to convey instructions, acknowledgement of instructions and essential information by using the following phrases and pronunciations and transmitting each phrase twice.

**Phrases for use by INTERCEPTED aircraft**

Phrase	Pronunciation <sup>1</sup>	Meaning
CALL SIGN (callsign) <sup>2</sup>	<b>KOL SA-IN</b> (callsign)	My callsign is (callsign)
WILCO	<b>VILL-KO</b>	Understood. Will comply
CAN NOT	<b>KANN NOTT</b>	Unable to comply
REPEAT	<b>REE-PEET</b>	Repeat your instruction
AM LOST	<b>AM LOSST</b>	Position unknown
MAYDAY	<b>MAYDAY</b>	I am in distress
HIJACK <sup>3</sup>	<b>HI-JACK</b>	I have been hijacked
LAND (place name)	<b>LAAND</b> (place name)	I request to land at (place name)
DESCEND	<b>DEE-SEND</b>	I require descent

<sup>1</sup>Syllables to be emphasised are printed in bold letters.

<sup>2</sup>The call sign required to be given is that used in radiotelephony communications with air traffic services units and corresponding to the aircraft identification in the flight notification.

<sup>3</sup>Circumstances may not always permit, nor make desirable, the use of the phrase “HIJACK”.

1.3.2 The phrases shown in the table below should be used by the intercepting aircraft and transmitted twice in the circumstances described in the preceding paragraph.

1.3.3 If any instructions received by radio from any sources conflict with those given by the intercepting aircraft by visual signals, the intercepted aircraft should request immediate clarification while continuing to comply with the visual instructions given by the intercepting aircraft.

1.3.4 If instructions received by radio from any sources conflict with those given by the intercepting aircraft by radio, the intercepted aircraft should request immediate clarification while continuing to comply with the radio instructions given by the intercepting aircraft.

1.3.5 The visual signals for use in the event of interception are detailed in section 2 below.

**Phrases for use by INTERCEPTING aircraft**

Phrase	Pronunciation <sup>1</sup>	Meaning
CALL SIGN	<b>KOL SA-IN</b>	What is your call sign?
FOLLOW	<b>FOL-LO</b>	Follow me
DESCEND	<b>DEE-SEND</b>	Descend for landing
YOU LAND	<b>YOU LAAND</b>	Land at this aerodrome
PROCEED	<b>PRO-SEED</b>	You may proceed

<sup>1</sup>Syllables to be emphasised are printed in bold letters.

**2. VISUAL SIGNALS FOR USE IN THE EVENT OF INTERCEPTION**

**2.1 Signals initiated by intercepting aircraft and responses by intercepted aircraft.**

Series	INTERCEPTING Aircraft Signals	Meaning	INTERCEPTED Aircraft Response	Meaning
1	<p><b>DAY or NIGHT</b> - Rocking aircraft and flashing navigational lights at irregular intervals (and landing lights in the case of a helicopter) from a position slightly above and ahead of, and normally to the left of, the intercepted aircraft (or to the right if the intercepted aircraft is a helicopter) and, after acknowledgement, a slow level turn, normally to the left (or to the right in the case of a helicopter) on the desired heading.</p> <p><i>Note 1. Meteorological conditions or terrain may require the intercepting aircraft to reverse the positions and direction of turn given above in Series 1.</i></p> <p><i>Note 2. If the intercepted aircraft is not able to keep pace with the intercepting aircraft, the latter is expected to fly a series of race track patterns and to rock the aircraft each time it passes the intercepted aircraft.</i></p>	You have been intercepted. Follow me.	<b>DAY or NIGHT</b> - Rocking aircraft, flashing navigational lights at irregular intervals and following.	Understood, will comply
2	<p><b>DAY or NIGHT</b> - An abrupt break-away manoeuvre from the intercepted aircraft consisting of a climbing turn of 90° or more without crossing the line of flight of the intercepted aircraft.</p>	You may proceed.	<b>DAY or NIGHT</b> - Rocking the aircraft.	Understood, will comply



Series	INTERCEPTING Aircraft Signals	Meaning	INTERCEPTED Aircraft Response	Meaning
3	<b>DAY or NIGHT</b> - Lowering landing gear (if fitted), showing steady landing lights and overflying runway in use or, if the intercepted aircraft is a helicopter, overflying the helicopter landing area. In the case of helicopters, the intercepting helicopter makes a landing approach, coming to hover near to the landing area.	Land at this aerodrome.	<b>DAY or NIGHT</b> - Lowering landing gear (if fitted), showing steady landing lights and following the intercepting aircraft and, if after overflying the runway in use or helicopter landing area, landing is considered safe, proceed to land.	Understood, will comply.

**2.2 Signals initiated by intercepted aircraft and responses by intercepting aircraft.**

Series	INTERCEPTED Aircraft Signals	Meaning	INTERCEPTING Aircraft Response	Meaning
4	<b>DAY or NIGHT</b> - Raising landing gear (if fitted) and flashing landing lights while passing over runway in use or helicopter landing area at a height exceeding 300M (1000FT) but not exceeding 600M (2000FT) (in the case of a helicopter, at a height exceeding 50M (170FT) but not exceeding 100M (330FT)) above the aerodrome level, and continuing to circle runway in use or helicopter landing area. If unable to flash landing lights, flash any other lights available.	Aerodrome you have designated is inadequate.	<b>DAY or NIGHT</b> - If it is desired that the intercepted aircraft follow the intercepting aircraft to an alternate aerodrome, the intercepting aircraft raises its landing gear (if fitted) and uses the <i>Series 1</i> signals prescribed for intercepting aircraft.  If it is decided to release the intercepted aircraft, the intercepting aircraft uses the <i>Series 2</i> signals prescribed for intercepting aircraft.	Understood, follow me.  Understood, you may proceed.
5	<b>DAY or NIGHT</b> - Regular switching on and off of all available lights but in such a manner as to be distinct from flashing lights.	Cannot comply.	<b>DAY or NIGHT</b> - Use <i>Series 2</i> signals prescribed for intercepting aircraft.	Understood.
6	<b>DAY or NIGHT</b> - Irregular flashing of all available lights.	In distress.	<b>DAY or NIGHT</b> - Use <i>Series 2</i> signals prescribed for intercepting aircraft.	Understood.

### 3. PROCEDURES FOR AIRCRAFT OPERATING IN AN AIR DEFENCE IDENTIFICATION ZONE

#### 3.1 General

3.1.1 The following general rules and procedures apply to enable identification of air traffic entering any designated ADIZ under the control of Australia.

3.1.2 An ADIZ is airspace of defined dimensions within which identification of all aircraft is required.

3.1.3 When a flight is intended to operate within an ADIZ, the pilot, unless exempted in accordance with paragraph 3.1.4, must:

- a. lodge a flight plan covering flight within the ADIZ with the appropriate ATS unit at least 60MIN before entry into the ADIZ;
- b. report position to ATS when passing each position reporting point within the ADIZ;
- c. report position to ATS at ADIZ boundary with a geographical reference (e.g., 15NM east of...) or, if the departure point is within 100NM of the ADIZ boundary, report departure;
- d. report departure if departing from a point in the ADIZ;
- e. maintain a continuous listening watch on the communications frequency of the appropriate ATS unit or on another frequency as directed until the flight is through the ADIZ;
- f. not deliberately deviate from tracks and altitudes filed in the flight plan unless prior ATC clearance is obtained, or, outside controlled airspace, notification is given to the appropriate ATS unit; and
- g. activate transponder when within 100NM of the ADIZ and when operating within the ADIZ.

3.1.4 The following flights over Australia and its territorial waters are exempted from compliance with the requirements of paragraph 3.1.3:

- a. a flight originating within a ADIZ which maintains a steady outbound track;
- b. a flight which remains within 10NM of the point of departure;
- c. aircraft performing published approach, holding or recovery procedures; and
- d. a flight conducted in accordance with special procedures arranged with the Area Air Defence Commander.

3.1.5 Flight plans lodged in accordance with paragraph 3.1.3 must include details of:

- a. tracks and altitudes to be flown while operating in the ADIZ;
- b. estimated elapsed times for each route segment in the ADIZ, including the segment in which the ADIZ boundary is crossed;
- c. position reporting points, departure and landing points; and
- d. estimated time at the commencing point of the first route segment for which details are required in accordance with sub-para b.

3.1.6 Reporting points published in aeronautical charts must be used plus those required by the Area Air Defence Commander.

3.1.7 Pilots must immediately notify ATS of any deviation from flight plan beyond the following tolerances:

- a. estimated time of commencing the ADIZ route segments -  $\pm 5$ MIN;
- b. over land area -  $\pm 10$ NM from track;
- c. over oceanic areas -  $\pm 20$ NM from track.

*Note: The five(5) minutes expressed in sub-para a. will be used in considering action under sub-section 4., but pilots must report predicted deviations of greater than two(2) minutes.*

3.1.8 In the event of failure of two-way radio communication, the pilot must proceed in accordance with the normal radio failure procedures.

#### 3.2 Special Requirements

3.2.1 Special requirements may be published relative to a particular ADIZ. Flights exempted in accordance with paragraph 3.1.4 will not be exempted from the special requirements unless so specified.

### 3.3 Non-Compliance

3.3.1 Significant deviations from the requirements for flight in an ADIZ must be reported immediately to ATS and details and reasons for the deviation must be reported at the first point of landing, for transmission to the Area Air Defence Commander.

### 3.4 Diversion of Aircraft for Defence Operations

3.4.1 The Regional Air Defence Commander may, through ATS, direct the flight of aircraft in the interests of national security. Messages initiating such requirements will be prefaced by 'MILITARY OPERATIONS REQUIRE...'

## 4. INTERCEPTION PROCEDURES

4.1 The following procedures should be used when it is necessary to intercept an aircraft for the purpose of visual identification:

### 4.2 Phase I

- a. The intercepting aircraft should approach the intercepted aircraft from astern.
- b. The element leader, or the single intercepting aircraft should normally take up position of the left side, slightly above and ahead of the intercepted aircraft, within the field of view of the pilot of the intercepted aircraft, and initially not closer than 300M.
- c. Any other participating aircraft should stay well clear of the intercepted aircraft, preferably above and behind. After speed and position have been established, the aircraft should, if necessary, proceed with Phase II of the procedure.

### 4.3 Phase II

- a. The element leader, or the single intercepting aircraft should begin closing in gently on the intercepted aircraft, at the same level, until no closer than absolutely necessary to obtain the information needed.
- b. The element leader, or the single intercepting aircraft, should use caution to avoid startling the flight crew or the passengers of the intercepted aircraft, keeping constantly in mind the fact that manoeuvres considered normal to an intercepting aircraft may be considered hazardous to passengers and crews of civil aircraft.
- c. Any other participating aircraft should continue to stay well clear of the intercepted aircraft.
- d. Upon completion of identification, the intercepting aircraft should withdraw from the vicinity of the intercepted aircraft as outlined in Phase III.

### 4.4 Phase III

- a. If identified as friendly, the element leader, or the single intercepting aircraft, should make the appropriate signal to proceed by a climbing turn of 90 degrees to port away from the intercepted aircraft.
- b. Any other participating aircraft should stay well clear of the intercepted aircraft and rejoin their leader.

4.5 The visual signal recommended for the use to attract the attention of the pilot in command of the intercepted aircraft is contained in Section 2 *Series 1*. If repeated attempts to attract attention by use of this signal are unsuccessful, other methods of signalling may be used for this purpose, including as a last resort the visual effect of the reheat/afterburner, provided that no hazard, including hazardous effect of wake turbulence, is created for the intercepted aircraft.

4.6 During daytime, the use of smoke producing devices may have the desired effect. During daytime as well as night, the use of high powered strobe lights, whenever installed on the intercepting aircraft for collision avoidance purposes, would also be of assistance.

4.7 As a very last resort, and if directed carefully, the use of reheat/ afterburner may achieve the desired result. This method is clearly most effective at night but can be both disturbing and noisy for the intercepted aircraft, especially if used within 300M. Reheat/afterburner must therefore be used with great caution.

4.8 Aircraft identified by intercept as:

- a. "Friendly" - should then proceed according to flight notification and/ or ATC instructions;
- b. "Unknown" - should be prepared to be shadowed, diverted or instructed to land at a suitable airfield; or
- c. "Hostile" - aircraft positively identified as "Hostile" may be engaged and destroyed.

#### **4.9 Guidance of an intercepted aircraft**

4.9.1 Navigational guidance and related information should be given to an intercepted aircraft by radiotelephony, whenever radio contact can be established.

4.9.2 When navigational guidance is given to an intercepted aircraft, care must be taken that the aircraft is not led into conditions where the visibility may be reduced below that required to maintain flight in VMC and that the manoeuvres demanded of the intercepted aircraft do not add to already existing hazards in the event that the operating efficiency of the aircraft is impaired.

4.9.3 In the exceptional case where an intercepted civil aircraft is required to land in the territory overflowed, care must also be taken that:

- a. the designated aerodrome is suitable for the safe landing of the aircraft type concerned, especially if the aerodrome is not normally used for civil air transport operations;
- b. the surrounding terrain is suitable for circling, approach and missed approach manoeuvres;
- c. the intercepted aircraft has sufficient fuel remaining to reach the aerodrome;
- d. if the intercepted aircraft is a civil transport aircraft, the designated aerodrome has a runway with a length equivalent to at least 2,500M at mean sea level and a bearing strength sufficient to support the aircraft; and
- e. whenever possible, the designated aerodrome is one that is described in detail in the AIP.

4.9.4 When requiring a civil aircraft to land at an unfamiliar aerodrome, it is essential that sufficient time be allowed it to prepare for a landing, bearing in mind that only the aircraft captain of the civil aircraft can judge the safety of the landing operation in relation to runway length and aircraft mass at the time.

4.9.5 It is particularly important that all information necessary to facilitate a safe approach and landing be given to the intercepted aircraft by radiotelephony.

**ENR 1.13 UNLAWFUL INTERFERENCE****1. PILOT ACTIONS**

1.1 An aircraft which is being subjected to unlawful interference must endeavour to inform ATS of this fact, along with any deviation from the current flight plan and any other significant factors affecting the operation. SSR-equipped aircraft should use an appropriate code. Information pertinent to the safe conduct of the flight will continue to be transmitted by ATS and appropriate action taken to expedite the conduct of the flight.



**ENR 1.14 AIR TRAFFIC INCIDENTS**

1. This section from Airservices Australia AIP not applicable to ADF.





## ENR 2. AIR TRAFFIC SERVICES AIRSPACE

### ENR 2.1 FIR, UIR, TMA

1. A full description of Australia's FIRs and TMAs is contained in Airservices Australia DAH. Further, diagrammatic presentation of Australia's TMAs is contained in aeronautical charts.

### ENR 2.2 OTHER REGULATED AIRSPACE

#### 1. OPERATIONS IN OCEANIC CONTROL AREA (OCA)

##### 1.1 Clearance Requirements

1.1.1 Aircraft not in receipt of an airways clearance in another FIR are required to obtain an airways clearance prior to entering Australian administered Class A airspace. Clearances may be issued by the primary guard station prior to FIR entry. If a clearance is not received 15 minutes prior to entry, it may be obtained directly by one of the following methods:

- a. Voice clearances may be obtained from Brisbane on INO-1, SEA-3, SP-6 or other advised frequencies as appropriate.
- b. CPDLC clearances may be obtained from Brisbane (YBBB) or Melbourne (YMMM), as appropriate.

##### 1.2 Mach Number Technique

1.2.1 Mach Number Technique (MNT) is the term used to describe the method of clearing successive jet aircraft, operating along the same track, to maintain specified mach numbers in order to maintain longitudinal separation.

1.2.2 The MNT may be used by ATC in the application of longitudinal separation standards on routes within oceanic controlled airspace. Pilots of jet aircraft must include the planned true Mach Number in their flight plans.

1.2.3 Pilots are required to readback and maintain an assigned Mach Number. ATC approval must be obtained before making any change. If an immediate temporary Mach Number change is essential (e.g., due to turbulence), ATC must be notified as soon as possible that such a change has been made.

1.2.4 MNT may also be applied by ATC in other Australian airspace.

#### 2. SPECIAL PROCEDURES FOR IN-FLIGHT CONTINGENCIES IN OCEANIC AIRSPACE

##### 2.1 Introduction

2.1.1 Although all possible contingencies cannot be covered, the procedures in *paras 2.2, 2.3 and 2.4* provide for the more frequent cases such as:

- a. the inability to comply with assigned clearance due to meteorological conditions (*para 2.4* refers);
- b. en route diversion across the prevailing traffic flow (for example, due to medical emergencies (*paras 2.2 and 2.3* refer)); and
- c. the loss of, or significant reduction in, the required navigation capability when operating in an airspace where the navigation performance accuracy is a prerequisite to the safe conduct of flight operations, or pressurisation failure (*paras 2.2 and 2.3* refer).

2.1.2 The pilot must take action as necessary to ensure the safety of the aircraft, and the pilot's judgement must determine the sequence of actions to be taken, having regard to the prevailing circumstances. ATC will render all possible assistance.

## 2.2 General procedures

2.2.1 If an aircraft is unable to continue the flight in accordance with its ATC clearance, a revised clearance must be obtained, whenever possible, prior to initiating any action.

2.2.2 If prior clearance cannot be obtained, the following contingency procedures should be employed until a revised clearance is received. In general terms, the aircraft should be flown at an offset level and on an offset track where other aircraft are less likely to be encountered. Specifically, the pilot should:

- a. leave the cleared track or ATS route by initially turning at least 30 degrees to the right or to the left, in order to establish and maintain a parallel, same direction track or ATS route offset by 5NM. The direction of the turn should be based on one or more of the following factors:
  - 1) Aircraft position relative to any organised track or ATS route system;
  - 2) The direction of flights and flight levels allocated on adjacent tracks;
  - 3) The direction to an alternate airport;
  - 4) Any strategic lateral offset being flown; and
  - 5) Terrain clearance;
- b. maintain a watch for conflicting traffic both visually and by reference to ACAS (if equipped), leaving ACAS in RA mode at all times, unless aircraft operating limitations dictate otherwise;
- c. turn on all aircraft exterior lights (commensurate with appropriate operating limitations);
- d. keep the SSR transponder on at all times and, when able, squawk 7700 as appropriate and, if equipped with ADS-B or ADS-C, select the appropriate emergency functionality;
- e. as soon as practicable, advise ATC of any deviation from their assigned clearance;
- f. use means as appropriate (i.e. voice and/or CPDLC) to communicate during a contingency or emergency;

*Note 1: When emergency situations are communicated via CPDLC, the controller may respond via CPDLC. However, the controller may also attempt to make voice contact with the aircraft.*

*Note 2: Guidance on emergency procedures for controllers, radio operators, and flight crew in data link operations can be found in the Global Operational Data Link (GOLD) Manual (Doc 10037).*

- g. if voice communication is used, use the radiotelephony distress signal (MAYDAY) or urgency signal (PAN PAN) preferably spoken three times, as appropriate; and
- h. establish communications with and alert nearby aircraft by broadcasting at suitable intervals on the frequency in use and on 121.5MHz (or, as a backup, on the inter-pilot air-to-air frequency 123.45MHz):
  - 1) aircraft identification;
  - 2) flight level;
  - 3) position including the ATS route designator or the track code, as appropriate;
  - 4) the nature of the distress condition; and
  - 5) intentions.

*Note: ATC will attempt to determine the nature of the emergency and ascertain any assistance that may be required. Subsequent ATC action with respect to that aircraft will be based on the intentions of the pilot and overall traffic situation.*

## 2.3 Actions to be taken once offset from track

*Note: The pilot's judgement of the situation and the need to ensure the safety of the aircraft will determine the actions outlined to be taken. Factors for the pilot to consider when deviating from the cleared track or ATS route or level without an ATC clearance include, but are not limited to:*

- a. operation within a parallel track system;
- b. the potential for User Preferred Routes (UPR) parallel to the aircraft's track or ATS route;
- c. the nature of the contingency (e.g. aircraft system malfunction); and
- d. weather factors (e.g. convective weather at lower flight levels).

2.3.1 If possible, maintain the assigned flight level until established on the 5NM parallel, same direction track or ATS route offset. If unable, initially minimise the rate of descent to the extent that is operationally feasible.

2.3.2 Once established on a parallel, same direction track or ATS route offset by 5NM, either:

- a. descend below FL 290, and establish a 500FT vertical offset from those flight levels normally used, and proceed as required by the operational situation or if an ATC clearance has been obtained, in accordance with the clearance; or

*Note 1: Flight levels normally used are those contained in ENR 1.7 Section 5.*

*Note 2: Descent below FL 290 is considered particularly applicable to operations where there is a predominant traffic flow (e.g. east-west) or parallel track system where the aircraft's diversion path will likely cross adjacent tracks or ATS routes. A descent below FL 290 can decrease the likelihood of conflict with other aircraft, ACAS RA events and delays in obtaining a revised ATC clearance.*

- b. establish a 500FT vertical offset (or 1,000FT vertical offset if above FL 410) from those flight levels normally used, and proceed as required by the operational situation, or if an ATC clearance has been obtained, in accordance with the clearance.

*Note: Altimetry System Errors (ASE) may result in less than 500FT vertical spacing (less than 1,000FT above FL410) when the above contingency procedure is applied.*

## 2.4 Weather Deviations

### 2.4.1 General

2.4.1.1 When weather deviation is required, the pilot should initiate communications with ATC via voice or CPDLC. A rapid response may be obtained by either:

- a. stating "WEATHER DEVIATION REQUIRED" to indicate that priority is desired on the frequency and for ATC response; or
- b. requesting a weather deviation using a CPDLC lateral downlink message.

2.4.1.2 When necessary, the pilot should initiate the communications using the urgency call "PAN PAN" (preferably spoken three times) or by using a CPDLC urgency downlink message.

2.4.1.3 The pilot must inform ATC when weather deviation is no longer required, or when a weather deviation has been completed and the aircraft has returned to its cleared route.

### 2.4.2 Actions to be taken when controller-pilot communications are established

2.4.2.1 The pilot should notify ATC and request clearance to deviate from track or ATS route, advising, when possible, the extent of the deviation requested. The flight crew will use whatever means are appropriate (i.e. voice and/or CPDLC) to communicate during a weather deviation.

*Note: Pilots are advised to contact ATC as soon as possible with requests for clearance in order to provide adequate time for the request to be assessed and acted upon.*

2.4.2.2 After communicating with ATC, the pilot:

- a. must comply with the ATC clearance issued; or
- b. when ATC are unable to issue a clearance for the requested deviation, should advise ATC of intentions and execute the procedures detailed in the following para 2.4.3.1.

### 2.4.3 Actions to be taken if a revised ATC clearance cannot be obtained

2.4.3.1 If the aircraft is required to deviate from track or ATS route to avoid adverse meteorological conditions and prior clearance cannot be obtained, an ATC clearance must be obtained at the earliest possible time. Until an ATC clearance is received, the pilot should take the following actions:

- a. If possible, deviate away from an organised track or ATS route system;
- b. Establish communications with and alert nearby aircraft by broadcasting, at suitable intervals on the frequency in use and on 121.5MHz (or, as a back-up, on the inter-pilot air-to-air frequency 123.45MHz):
  - 1) aircraft identification;
  - 2) flight level;
  - 3) position including ATS route designator or the track code; and
  - 4) intentions.

- c. Watch for conflicting traffic both visually and by reference to ACAS (if equipped);
- d. Turn on all exterior lights (commensurate with appropriate operating limitations);
- e. For deviations of less than 5NM from the originally cleared track or ATS route, remain at a level assigned by ATC;
- f. For deviations greater than or equal to 5NM from the originally cleared track or ATS route, when the aircraft is approximately 5NM from track, initiate a level change in accordance with the following table:

Originally cleared track or ATS route centre line	Deviations > 5NM	Level Change
EAST 000°-179° magnetic	LEFT RIGHT	DESCEND 300FT CLIMB 300FT
WEST 180°-359° magnetic	LEFT RIGHT	CLIMB 300FT DESCEND 300FT

- g. If the pilot receives clearance to deviate from cleared track or ATS route for a specified distance and, subsequently, requests, but cannot obtain a clearance to deviate beyond that distance, the pilot should apply an altitude offset in accordance with the table above before deviating beyond the cleared distance;
- h. When returning to track or ATS route, be at its assigned flight level when the aircraft is within approximately 5NM of the centre line; and
- i. If contact was not established prior to deviating, continue to attempt to contact ATC to obtain a clearance. If contact was established, continue to keep ATC advised of intentions and obtain traffic information.

*Note: If, as a result of actions taken under the provisions of this paragraph, the pilot determines that there is another aircraft at or near the same flight level with which a conflict may occur, then the pilot is expected to adjust the path of the aircraft, as necessary, to avoid conflict.*

### 3. STRATEGIC LATERAL OFFSET PROCEDURES (SLOP) IN OCA

3.1 Aircraft operating in OCA within Australian administered airspace are authorised to use strategic lateral offset procedures (SLOP) in accordance with the requirements detailed in [paragraph 3.2](#).

3.2 The following requirements apply to the use of SLOP:

- a. The offset must only be applied by aircraft with automatic offset tracking capability.
- b. The offset must be established in tenths of a nautical mile up to a maximum of 2NM to the RIGHT of track relative to the direction of flight.

*Note: Offsets to the left of track are not permitted.*

- c. The offset must only be applied during the en-route phase of flight.
- d. The offset may only be used in OCA. Pilots must fly the route centreline for any portion of their route within CTA. Pilots must return to centreline before leaving OCA or, where the subsequent state does not allow SLOP, prior to leaving Australian administered airspace.
- e. The offset must not be used in addition to diversions or other offsets; e.g. weather or wake turbulence.
- f. The offset must not be applied at levels where obstacle clearance would be affected.
- g. Identified aircraft:
  - 1) may continue an offset in OCA; and
  - 2) must advise ATC prior to initiating or changing an offset.

3.3 The decision to apply SLOP is the responsibility of the aircraft captain - a clearance is not required. Except when an identified aircraft initiates or changes a lateral offset, pilots are not required to notify ATC that SLOP are being applied.

3.4 The use of SLOP is recommended in OCA for aircraft cruising at levels not in compliance with the table of cruising levels specified at ENR 1.7 [Section 5](#).

3.5 OCA is depicted on Australian AIP charts as follows:

- a. From 150NM SSE of YBBN south to 200NM NNE of YSSY - the blue line depicting the Class C airspace boundary.
- b. South of 150NM SE of YSSY - the FIR boundary.
- c. Remainder - the brown line depicting the Class E airspace boundary.

#### **4. USE OF GNSS IN OCEANIC AND REMOTE AREAS**

4.1 ADF - Australia has approved the use of GNSS as a primary means of navigation for oceanic/remote areas. The use by a MAO of GNSS in these areas as a primary means of navigation must be approved by DASA.

4.2 To ensure navigation integrity, an appropriate en route GNSS prediction analysis, using the software provided by the GNSS manufacturer, must be conducted prior to each flight. For this analysis, the following parameters or equivalents, must be used:

- a. the route or airspace RNP, where published; or
- b. a centreline space of:
  - 1) 20NM for flight in CTA, and
  - 2) 50NM for flight in OCA.

4.3 Aircraft meeting the requirements for the use of GNSS as a primary means of navigation in oceanic/remote continental airspace must indicate the approval in the flight notification. Such aircraft may flight plan on designated Area Navigation routes within Australian FIRs.

#### **5. OPERATIONS IN OCEANIC AIRSPACE REQUIRING PERFORMANCE-BASED COMMUNICATION AND SURVEILLANCE (PBCS) AUTHORISATION**

5.1 ICAO have introduced new provisions on PBCS calling for States to prescribe Required Communication Performance (RCP) and Required Surveillance Performance (RSP) specifications in their airspace as appropriate to the level of air traffic services provided. RCP 240 and RSP 180 are being applied in addition to Required Navigation Performance (RNP) specifications to certain separation minima in oceanic airspace by some States.

5.2 Australia has filed a difference with ICAO and has not yet implemented RCP or RSP.

5.3 Flights proceeding outside Australia should be aware that some States have prescribed RCP 240 and RSP 180 specifications in their administered airspace. Those States may require operators to be authorised by CASA to declare their RCP and RSP capabilities and for entering the respective descriptors in their flight plans.

5.4 CASA has issued an Instrument, number CASA 33/18 - Required Communication Performance and Required Surveillance Performance (RCP 240 and RSP 180) Capability Declarations - Direction 2018, which states the requirements for Australian operators to assess their compliance to RCP 240 and RSP 180 specifications and declare their readiness by entering the respective RCP and RSP descriptors in their flight plans.

5.5 Guidance on PBCS and the subject CASA Instrument is provided in Advisory Circular (AC) 91-06 V1.0.



**ENR 3 ATS ROUTES****ENR 3.1 LOWER ATS ROUTES**

1. Details regarding lower ATS routes in Australia FIR can be found in the *DAH*.

**ENR 3.2 UPPER ATS ROUTES**

1. Details regarding upper ATS routes in Australian FIRs can be found in the *DAH*.

**ENR 3.3 AREA NAVIGATION ROUTES**

1. Details regarding Area Navigation routes in Australian FIRs can be found in the *DAH*.
2. Information regarding which GNSS equipment can be used for different navigation specifications (i.e. RNP or RNAV) can be found in the *CASR Part 91*; acceptable means of compliance and guidance material (AMC/GM) is available on the CASA website.

**ENR 3.4 HELICOPTER ROUTES**

1. Details regarding helicopter routes and lanes-of-entry to specified airports can be found in ERSA FAC.

**ENR 3.5 OTHER ROUTES**

1. Details of all routes in Australian FIRs can be found in Airservices Australia *DAH*. Information concerning flight planning restrictions can be found in ERSA GEN.

**ENR 3.6 EN ROUTE HOLDING**

1. En route holding positions are identified on AIP aeronautical charts.
2. Further details regarding:
  - a. En route holding may be found in FIHA ENR 1.5 [Section 3](#).
  - b. Holding Fuel requirements are contained in FIHA ENR 1.1 [Section 10](#).
  - c. ATFM procedures are contained in FIHA ENR 1.9.





**ENR 4 RADIO NAVIGATION AIDS/SYSTEMS****ENR 4.1 RADIO NAVIGATION AIDS - EN ROUTE**

1. En route radio navigation aids for all ATS routes are identified in Airservices Australia *DAH* and on aeronautical charts.

**ENR 4.2 SPECIAL NAVIGATION SYSTEMS**

1. There are no special navigation systems in existence in Australian FIRs.

**ENR 4.3 GLOBAL NAVIGATION SATELLITE SYSTEM (GNSS)**

1. No SBAS signal should be used for navigation in Australian airspace until the Southern Positioning Augmentation Network (SouthPAN) is commissioned for safety of life applications including aeronautical navigation.

2. SouthPAN (Service Provider Identifier 8) is radiating test configuration SBAS L1 and DFMC services. Both services are not available for aeronautical navigation, and this is indicated by transmission of Message Type 0. A pilot in command becoming aware of irregular operation of a navigation function due to SouthPAN testing should report to the appropriate ATS unit in accordance with *ENR 1.1 para 10.10.1*. The keyword 'SouthPAN' should be included in any report.

**ENR 4.4 NAME-CODE DESIGNATORS FOR SIGNIFICANT POINTS**

1. The five-letter codes and respective geographical coordinates for IFR waypoints in Australian FIRs are listed in *ERSA GEN* and identified on en route charts.

**ENR 4.5 AERONAUTICAL GROUND LIGHTS - EN ROUTE**

1. Aeronautical ground lights may indicate visual lanes of entry at some Class D aerodromes. If present, these lights are identified on Airservices Australia Visual Terminal Charts (VTC).

2. Aerodrome beacons and hazard beacons for particular locations are identified in *ERSA FAC*.



## ENR 5. NAVIGATION WARNINGS

### ENR 5.1 PROHIBITED, RESTRICTED, DANGER AND MILITARY OPERATING AREAS

#### 1. GENERAL

1.1 Airspace in which a potential hazard to aircraft operations may exist, and all areas over which the operation of civil aircraft may be restricted are promulgated as follows:

- a. Prohibited Area;
- b. Restricted Area;
- c. Danger Area; or
- d. Military Operating Area (MOA)

1.2 Details of PRD and MOA are promulgated in the DAH, ERSA and/or NOTAM, and depicted on AIP aeronautical charts. PRD and MOA are identified using:

- a. a letter, as follows
  - 1) P – Prohibited Area
  - 2) R – Restricted Area
  - 3) D – Danger Area
  - 4) M – Military Operating Area
- b. a number, to identify the specific area.

1.3 Temporary Restricted, Danger and Military Operating Areas, such as for military exercises, air shows and special events, are promulgated by AIP SUP, or as Brisbane FIR (YBBB) or Melbourne FIR (YMMM) NOTAM as appropriate for the location. Temporary areas are identified using:

- a. a temporary airspace identifier:
  - 1) TRA – temporary Restricted Area
  - 2) TDA – temporary Danger Area
  - 3) TM – temporary Military Operating Area, and
- b. an additional airspace identifier such as:
  - 1) the airspace name e.g. 'Coral South', and/or
  - 2) numbers from the 900 series, i.e. numbers that start with a nine e.g. TRA940.

1.4 Unless otherwise specified, vertical limits are promulgated as AMSL when at or below the transition altitude, or as a flight level when above the transition altitude. The abbreviation "SFC" means the surface of the ground or water. "NOTAM" indicates that the vertical limits or hours of activation will be notified by NOTAM.

1.5 The promulgated vertical limits of Prohibited, Restricted and Military Operating Areas include all the buffers necessary for the protection of aircraft operating outside these areas. Therefore, the promulgated levels may be used by aircraft avoiding the areas, except where the vertical limit abuts controlled airspace, in which case, a clearance is required.

#### 2. FLIGHT WITHIN PRD AND MOA

2.1 Flight within a Prohibited Area is not permitted in any circumstances.

2.2 Flight within active Restricted Areas is subject to the conditions published in AIP, ERSA, DAH and NOTAM. To obtain access to a Restricted Area, pilots must request approval from the controlling authority (see ERSA). When an ATC service is available within that airspace, approval may be requested from ATC directly, in the same manner as a clearance request to enter controlled airspace.

*Note: Clearances may be withheld when activities hazardous to the aircraft are taking place, or when those activities require absolute priority.*

2.3 All Restricted Areas have been allocated an RA conditional status to indicate the likelihood of obtaining a clearance to fly through the area.

Conditional Status	Meaning
RA1	Pilots may flight plan through the Restricted Area and, under normal circumstances, expect a clearance from ATC.
RA2	<b>Pilots must not flight plan through the Restricted Area</b> unless on a route specified in ERSAs GEN FPR or under agreement with the controlling authority. Even so, a clearance from ATC is not assured. Other tracking may be offered through the Restricted Area on a tactical basis.
RA3	<b>Pilots must not flight plan through the Restricted Area</b> and clearances will not be available.
<i>Note 1: NOTAM may be issued to indicate changes to the conditional status, which should be checked prior to flight planning.</i>	
<i>Note 2: In a declared emergency, every effort will be made to obtain approval to transit a Restricted Area, irrespective of its conditional status.</i>	

2.4 If the conditional status is uncertain, treat the Restricted Area as conditional status RA3 and avoid the area.

2.5 Approval for flight within an active Danger Area outside controlled airspace is not required. However, it is the responsibility of the pilot in command to be aware of the dangerous activity and take appropriate precautions.

2.6 MOA are generally established to encompass intensive military activities, including live firing. For non-participating aircraft, flight within active MOA is generally only approved in exceptional circumstances.

MOA have the same entry approval requirements as Restricted Areas:

- a. For all aircraft within Australian territory (including Australian territorial waters which are generally up to 12NM offshore); and
- b. Only Australian registered aircraft outside Australian territory.

2.6.1 Outside Australian territory, foreign registered aircraft are not subject to MOA entry control, however flights electing to transit an active MOA without approval will not receive an air traffic control service and protection from dangerous activities occurring in the MOA cannot be provided. A limited FIS and SAR service will be available from civil ATS, in accordance with the relevant flight rules.

The Pilot in Command should take appropriate precautions against any safety risks that could arise from the flight, including contacting the MOA administering authority and identifying their operation. Where contact cannot be made with the MOA administering authority, squawk 7700 and broadcast at suitable intervals on 121.5 MHz including aircraft identification, position, flight level, and intentions.

2.7 Restricted, Danger and Military Operating Areas may be activated or deactivated at short notice. Access to a Restricted or Military Operating Area may be available if the activity for which it has been activated has ceased (early deactivation). It is a pilot responsibility to check current status with ATS.

**ENR 5.2 MILITARY EXERCISE AND TRAINING AREAS AND AIR DEFENCE IDENTIFICATION ZONE (ADIZ)**

**1. MILITARY SENSITIVE AREAS**

*Note 1: These areas are applicable to military activities only.*

*Note 2: See also ENR 5.6.*

*Note 3: Levels are AGL unless specified otherwise.*

**1.1 Brisbane FIR**

**1.1.1 YB/S1- Katherine Gorge**

Overfly at or above 2,500FT AMSL or remain outside the area bounded by 141554S 1322406E - 141454S 1323706E - 141954S 1323606E - 141954S 1322406E - 141554S 1322406E.

**1.1.2 YB/S2 - Newcastle/Stockton**

Overfly at or above 2,000FT or remain outside the area bounded by 325118S 1514218E - south bank of Hunter River 325224S 1514300E - 325224S 1514836E - 325942S 1514836E clockwise around arc radius 5NM centre 325554S 1514218E - 325118S 1514218E.

**1.1.3 YB/S3 - Singleton City**

Overfly at or above 2,000FT or remain outside a circle radius 1NM centre 322354S 1511106E.

**1.1.4 YB/S4 - Legges Camp / Bombah Point**

Overfly at or above 2,000FT or remain outside a circle radius 1NM centre 322954S 1521806E.

**1.1.5 YB/S5 - Largs**

Overfly at or above 2,000FT or remain outside a circle radius 1NM centre 324154S 1513606E.

**1.1.6 YB/S6 - Siding Spring Observatory**

Aircraft operating outside controlled airspace are to remain outside the following circular areas centre 311630S 1490406E.

Aircraft operating in controlled airspace are to remain on track unless otherwise instructed by ATC.

SFC to 10,000FT AMSL	3NM radius
10,000FT to FL200	5NM radius
FL200 to FL300	8NM radius
FL300 to FL450	12NM radius
above FL450	17NM radius

**1.1.7 YB/S7 - Leadville**

Overfly at or above 1,000FT or remain outside a circle radius 3NM centre 320100S 1493018E.

**1.1.8 YB/S8 - Saxonvale Mine**

All military aircraft are advised caution is to be exercised flying over coal mines adjacent to west boundary Singleton firing ranges/training areas.

Mine operator advises vertical danger to unspecified heights exists during regular explosive blasting in pits. Aircraft should avoid overflying pits, but no restrictions exist overflying mine buildings, or other parts of mine operation.

Saxonvale is the southern mine of the two.

**1.1.9 YB/S9 - Pallarenda**

Overfly at or above 2,000FT or remain outside a circle radius 1NM centre 191206S 1464624E. Aircraft departing/arriving Townsville are to comply with avoidance instructions issued by Townsville ATC.

**1.1.10 YB/S10 Great Barrier Reef Marine Park (Far Northern Section)**

Overfly at or above 3,000FT or remain outside the following circular areas radius 3NM and centres:

Ashmore Banks	114754S 115118S 115354S	1433818E 1433536E 1433906E
Boydong Islet and Reef	112854S 112954S	1430106E 1430506E
Bird Islet	114554S	1430536E
Burkitt Island	135654S	1434518E
Bushy Island and Reef	111454S 113454S 114354S	1425306E 1425406E 1425806E
Cairncross Island and Reef	111354S	1425506E
Cholmondeley Islet and Reef	112154S	1430306E
Clack Island and Reef	140354S	1441506E
Combe Island and Reef	142412S	1445424E
Coquet Island	143224S	1445936E
Davie Reef	135842S	1442654E
Douglas Island and Reef	111354S	1425906E
Fife Island and Reef	133854S	1434306E
Hannah Island	135154S	1434306E
Hay Island	134006S	1434136E
Houghton Island	143124S	1445836E
Howick Island	143006S	1445836E
Ingham Island	142506S	1445318E
King Island and Reef	140554S	1442006E
Lloyd Island and Reef	124554S	1432406E
Lowrie Islet	131624S	1433548E
MacArthur Islands	114354S	1425906E
MacLennan Reef	112412S	1434636E
Magra Islet and Reef	115154S	1431706E
Morris Island and Reef	132854S	1434306E
Moulter Reef	112442S	1435936E
Newton Island	143024S	1445506E
Night Island	131054S	1433436E
Pelican Island and Reef	135442S	1435006E
Pipon Island and Reef	140654S	1443106E
Quoin Island	122418S	1432936E
Raine Island	113606S	1440154E

Reef	132612S	1435818E
Reef	132136S	1435736E
Saunders Islet	114154S 114254S	1431106E 1431206E
Sinclair Island and Reef	143254S	1445406E
Sinclair Islet and Reef	110654S	1430106E
Sir Charles Hardy Island	115354S	1432806E
Stainer Islet	135724S	1435006E
Tydeman Reef	135900S	1443018E
Wallace Island and Reef	112654S	1430206E
West Hannibal Lighthouse	113554S	1425706E
Wilke Island	134618S	1433830E

**1.1.11 YB/S11 Great Barrier Reef Marine Park (Cairns Section)**

Overfly at or above 3,000FT or remain outside the following circular areas radius 3NM and centres:

Agincourt Reefs	155948S	1455000E
Beaver Reef	175006S	1462906E
Eagle Island and Reef	144154S	1452306E
Green Island	164530S	1455806E
Hastings Reef	163112S	1460124E
Hope Islands	154454S	1452706E
Low Islets	162306S	1453418E
Low Wooded Island and Reef	150554S	1452306E
Mackay Reef	160254S	1453906E
Michaelmas Reef	163618S	1455900E
Nymph Island	143854S	1451506E
Rocky Islets	145136S	1452900E
Stephens Island and Reef	174354S	1461006E
Taylor Reef	175006S	1463342E
Three Isles	150654S	1452536E
Turtle Island	144312S	1451130E
Two Islands	150112S	1452654E
Undine Reef	160654S	1454006E

**1.1.12 YB/S12 - Great Barrier Reef Marine Park (Central Section)**

Overfly at or above 3,000FT or remain outside the following circular areas radius 3NM and centres:

Brook Islands	180836S	1461718E
Dunk Island	175636S	1460924E
Eshelby Island	200112S	1483736E
Family Islands	180218S	1461048E
Hardy Reef	194542S	1491354E
John Brewer Reef	183806S	1470348E

**1.1.13 YB/S13 - Great Barrier Reef Marine Park (Mackay/Capricorn Section)**

Overfly at or above 3,000FT or remain outside the following circular areas radius 3NM and centres:

Bell Cay	214848S	1511454E
Bushy Island	205730S	1500506E
Bylund Cay	214712S	1522442E
Gannett Cay	215854S	1522830E
Frigate Cay	214424S	1522506E
Price Cay	214712S	1522636E
Redbill Island	205824S	1500506E
Thomas Cay	213854S	1522136E

**1.1.14 YB/S14 - Great Barrier Reef Marine Park (Southern Section)**

Overfly at or above 3,000FT or remain outside the following circular areas radius 3NM and centres:

Fairfax Islands	235124S	1522224E
Heron Island	232630S	1515448E
Hoskyn Islands	234812S	1521748E
Lady Elliot Island	240654S	1524236E
Lady Musgrave Island	235424S	1522336E
Masthead Islet	233212S	1514436E
North Reef	231100S	1515424E
North West Island	231748S	1514224E
One Tree Island	233024S	1520530E
Tryon Island	231448S	1514636E
Wilson Island	231818S	1515454E
Wreck Island	231954S	1515718E



**1.1.15 YB/S15 - Pelican Rock/Akens Island**

During the months October to March, the rock is a nesting area for pelicans. Pilots of low flying aircraft are requested to avoid the area over and near 222024S 1501536E as far as practicable during this period.

**1.1.16 Restricted and Military Operating Areas withing Marine Parks**

1.1.16.1 The existing military Restricted and Military Operating Areas that are located within a marine park have been identified in the Queensland State Marine Parks Act Zoning Plans. The Great Barrier Reef Marine Park Regulations 2019, as well as other Marine Park Zoning Plans, contain restrictions regarding aircraft operations in the vicinity of whales. Although the conduct of military operations within Restricted and Military Operating Areas is not constrained, military pilots are requested to comply with the following requirements based on the legislation and zoning plans, particularly during the migratory period between 1 August and 30 November:

- a. not operate an aircraft below 1,000FT within 300M of a whale, and
- b. not operate a helicopter below 2,000FT within 1KM of a whale.

1.1.16.2 Whenever possible, prior notification of military flights within a marine park should be provided to the Assistant Director Marine Parks, Queensland Department of Environment and Heritage, PO Box 155 North Quay Queensland 4002.

**1.2 Melbourne FIR**

**1.2.1 YM/S1 - Altona**

Overfly at or above 500FT and preferably by 1,500FT or remain outside a circle radius 0.5NM centre 375106S 1444824E.

**1.2.2 YM/S2 - Sarsfield**

Overfly at or above 1,000FT or remain 5NM outside a circle radius 5NM centre ESL 040034 (374454S 1474248E).

**1.2.3 YM/S3 - Clyde River Valley**

Overfly at or above 4,000FT or remain outside an area bounded by a semicircle of 2NM radius centred on Nelligen (353854S 1500806E) thence 2NM either side of the Clyde river, Northbound to join a semicircle radius 2NM centre on Brooman (352754S 1501424E).

**1.2.4 YM/S4 - Mt Stromlo Observatory**

Aircraft operating outside controlled airspace are to remain outside the following circular areas centre 351912S 1490024E.

Aircraft operating in controlled airspace are to remain on track unless otherwise instructed by ATC.

SFC to 10,000FT AMSL	1NM radius
10,000FT to FL200	5NM radius
FL 200 to FL300	8NM radius
FL300 to FL450	12NM radius
Above FL450	17NM radius

### 1.3 Permanent Drilling Rigs

1.3.1 Oil and gas platforms (land and sea) are declared sensitive areas. They are to be avoided by an airspace of 1,000FT vertically and 1NM horizontally. Permanent Drilling Rigs are listed below.

Barracouta	381749S	1474034E
Whiting	381424S	1475226E
Snapper	381139S	1480132E
Marlin	381350S	1481315E
Tuna	381012S	1482510E
West Tuna	381133S	1482319E
Flounder	381841S	1482622E
Halibut	382416S	1481913E
Fortescue	382427S	1481641E
Cobia	382659S	1481833E
Mackerel	382846S	1482034E
Kingfish B	383550S	1481117E
Kingfish A	383548S	1480841E
West Kingfish	383536S	1480620E
Bream B	383102S	1475020E
Bream A	383000S	1474620E
Dolphin	382914S	1472239E
Perch	383409S	1471921E

## 2. MILITARY AAR AND AEW&C AIRSPACE

### 2.1 General

The conduct of Air to Air Refuelling (AAR) and Airborne Early Warning and Control (AEW&C) operations is based on the strict requirement that participating aircraft remain within specifically designated airspace. In general AAR and AEW&C operations in Australian airspace are conducted on tracks and in anchor patterns published in this document. Where mission requirements necessitate operations outside of published areas refer to Australian Defence Force Flight Information Handbook Australia (ADF FIHA) for planning information.

AAR operations will be conducted under instrument flight rules. The tanker aircraft is responsible for requesting altitude clearance and routing, if different than flight plan routing, for the receiver(s) and tanker beyond the AR Exit point. Throughout the refuelling operation, controller initiated heading assignments may not be effected without a clearance from the tanker. Each aircraft must receive a specific clearance prior to leaving the refuelling track/anchor if outside Military Restricted airspace.

**2.2 Explanation of terms**

**2.2.1 Refuelling tracks**

- a. **RVIP – Rendezvous Initial Point.** A planned geographic point prior to the RVCP to which tankers and receivers time independently to effect an arrival at the RV control time.
- b. **RVCP –Rendezvous Control Point.** The planned geographic point over which the receiver(s) arrive in the observation/astern position with respect to the assigned tanker.
- c. **Navigation Checkpoints.** Designated points where required to provide a means for adequate navigation along track.
- d. **Exit.** The point at which the refuelling track terminates.
- e. **Communication / Rendezvous Plan (C/R Plan):**
  - 1) Primary UHF
  - 2) Backup UHF
  - 3) APN 69/134/135 Settings
  - 4) APX 78/Encode/Decode
  - 5) TACAN Channels Receiver/Tanker
  - 6) N/R = Not required
- f. **Refuelling Altitudes.** The block of airspace within which refuelling operations may be conducted.
- g. **Scheduling Unit.** The military unit responsible for scheduling AAR operations along the route.
- h. **Assigned Centre.** Primary airspace control authority.
- i. **SODAR.** Simultaneous Opposite Direction Air Refuelling.

**2.2.2 Refuelling Anchors**

- a. **Entry Points.** Designated points where tanker aircraft may enter the anchor area without the assistance of radar. When tanker is actively controlled by ATC or GCI the tanker may proceed to the anchor point without crossing an Entry point.
- b. **Anchor Point/Inbound Course/Leg length.** The geographic point upon which the anchor pattern is oriented and the inbound course to the anchor point and the length of the inbound leg.
- c. **Anchor Pattern.** A left hand pattern with the four defining points of the pattern.
- d. **Exit Point.** Designated points where tanker and receiver aircraft may depart the anchor area after refuelling is complete. Under positive radar control tanker and receiver aircraft may exit anchor pattern without crossing an exit point.

2.3 Amberley AAR and AEW&C airspace

ENTRY POINTS	RVIP	ANCHOR PT/ IB COURSE/ PATTERN LEN	ANCHOR PATTERN	EXIT POINTS	CR PLAN	REFUEL ALTS	SCHED UNIT	ASSIGNED CENTRE	TIMES OF OPS
AM11 262906.0S 1540454.0E	262906.0S 1540454.0E	260606.0S 1544800.0E (AM11C) 048° 45NM	260606.0S 1544800.0E 254854.0S 1543636.0E 261148.0S 1535330.0E 262906.0S 1540454.0E	261148.0S 1535330.0E	a. 301.500 b. TBA c. reserved d. reserved e. 33/96	FL200/ FL300	33SQN OPS 0753610033	RAAF CRU (FREQ TBA) if M640C/D active, Brisbane (As assigned) if M640C/D deactivated	NOTAM
<p><b>AIRSPACE:</b> 261542S 1532954E (AMX100) - 244942S 1550206E (AMX101) - 253930S 1555400E (AMX102) - 264642S 1535330E (AMX103) - 261542S 1532954E (AMX100).</p> <p><b>REMARKS:</b> Pattern size: 45NM x 20NM. Pattern exists within M640C and D (5000-NOTAM).</p>									
AM13 273136.0S 1551154.0E	273136.0S 1551154.0E	270654.0S 1555430.0E (AM13C) 045° 45NM	270654.0S 1555430.0E 265006.0S 1554200.0E 271448.0S 1545936.0E 273136.0S 1551154.0E	271448.0S 1545936.0E	a. 301.500 b. TBA c. reserved d. reserved e. 33/96	FL200/ FL300	33SQN OPS 0753610033	RAAF CRU (FREQ TBA) if M649B active, Brisbane (As assigned) if M649B deactivated	NOTAM
<p><b>AIRSPACE:</b> 274630.0S 1544430.0E (AMX104) - 271312.0S 1544430.0E (AMX105) - 263324.0S 1554654.0E (AMX106) - 261548.0S 1563030.0E (AMX107) - 271636.0S 1573106.0E (AMX108) - 285012.0S 1563754.0E (AMX109) - 274630.0S 1544430.0E (AMX104).</p> <p><b>REMARKS:</b> Pattern size: 45NM x 20NM. Pattern exists within M649B (5000-NOTAM).</p>									

ENTRY POINTS	RVIP	ANCHOR PT/ IB COURSE/ PATTERN LEN	ANCHOR PATTERN	EXIT POINTS	CR PLAN	REFUEL ALTS	SCHED UNIT	ASSIGNED CENTRE	TIMES OF OPS
AM15	300436.0S 1541700.0E	292430.0S 1544042.0E (AM15C) 015° 45NM	292430.0S 1544042.0E 291524.0S 1542018.0E 295530.0S 1535630.0E 300436.0S 1541700.0E	295530.0S 1535630.0E	a. 301.500 b. TBA c. reserved d. reserved e. 33/96	FL200/ FL300	33SQN OPS 0753610033	RAAF CRU (FREQ TBA) if M661A active, Brisbane (As assigned) if M661A deactivated	NOTAM

**AIRSPACE:** 285212.0S 1534942.0E (AMX110) - 282912.0S 1535736.0E (AMX111) - 283348.0S 1540918.0E (AMX112) - 291324.0S 1550712.0E (AMX113) - 302812.0S 1542554.0E (AMX114) - 301854.0S 1532930.0E (AMX115) - 293924.0S 1533736.0E (AMX116) then along the minor arc of a circle radius 30.00NM centre 291154.0S 1532342.0E - 285212.0S 1534942.0E (AMX110).

**REMARKS:** Pattern size: 45NM x 20NM. Pattern exists within M661A (5000-NOTAM).

AM17	290512.0S 1503006.0E	283500.0S 1505924.0E (AM17C) 030° 45NM	283500.0S 1505924.0E 282206.0S 1504218.0E 285218.0S 1501254.0E 290512.0S 1503006.0E	285218.0S 1501254.0E	a. 301.500 b. TBA c. reserved d. reserved e. 33/96	FL200/ FL300	33SQN OPS 0753610033	RAAF CRU (FREQ TBA) if R639D active, Brisbane (As assigned) if R639D deactivated	NOTAM
------	-------------------------	--	--	-------------------------	--	-----------------	-------------------------	---	-------

**AIRSPACE:** 292212.0S 1500918.0E (AMX117) - 282830.0S 1495324.0E (AMX125) - 280830.0S 1510336.0E (AMX126) - 281942.0S 1510848.0E (AMX127) - 283530.0S 1512036.0E (AMX128) - 284430.0S 1512942.0E (AMX129) - 292218.0S 1500918.0E (AMX117).

**REMARKS:** Pattern size: 40NM x 20NM. Pattern exists within R639D (10000-NOTAM).

ENTRY POINTS	RVIP	ANCHOR PT/IB COURSE/PATTERN LEN	ANCHOR PATTERN	EXIT POINTS	CR PLAN	REFUEL ALTS	SCHED UNIT	ASSIGNED CENTRE	TIMES OF OPS
<b>AM19</b>									
281136.0S	281136.0S	274112.0S	274112.0S	275830.0S	a. 301.500	FL200/	33SQN OPS	RAAF CRU	NOTAM
1501548.0E	1501548.0E	1504512.0E	1504512.0E	1495842.0E	b. TBA	FL300	0753610033	(FREQ TBA)	
		(AM19C)	272812.0S		c. reserved			if R639C	
		030°	1502806.0E		d. reserved			active,	
		40NM	275830.0S		e. 33/96			Brisbane	
			1495842.0E					(As assigned)	
			281136.0S					if R639C	
			1501548.0E					deactivated	

**AIRSPACE:** 281000.0S 1494800.0E (AMX118) - 265739.0S 1494406.0E (AMX130) - 271742.0S 1505342.0E (AMX131) - 272830.0S 1505306.0E (AMX132) - 274500.0S 1505536.0E (AMX133) - 280106.0S 1510012.0E (AMX134) - 280830.0S 1510336.0E (AMX135) - 282830.0S 1495324.0E (AMX136) - 281000.0S 1494800.0E (AMX118).

**REMARKS:** Pattern size: 40NM x 20NM. Pattern exists within R639C (10000-NOTAM).

<b>AM22</b>									
241348.0S	241348.0S	245112.0S	245112.0S	240030S	a. 301.500	FL200/	33SQN OPS		NOTAM
1543754.0E	1543754.0E	1551424.0E	1551424.0E	1545418E	b. TBA	FL300	0753610033		
		(AM22C)	243754.0S		c. reserved				
		125°	1553048.0E		d. reserved				
		50NM	240030.0S		e. 33/96				
			1545418.0E						
			241348.0S						
			1543754.0E						

**AIRSPACE:** 250654.0S 1551954.0E (AMX200) - 244942.0S 1550206.0E (AMX201) - 240824.0S 1541948.0E (AMX202) - 234554.0S 1544730.0E (AMX203) - 244542.0S 1554554.0E (AMX204) - 250654.0S 1551954.0E (AMX200).

**REMARKS:** Pattern size: 50NM x 20NM. Airspace size: 80NM x 30NM. No current procedure available for anchor AAR operations outside Military controlled airspace.

ENTRY POINTS	RVIP	ANCHOR PT/ IB COURSE/ PATTERN LEN	ANCHOR PATTERN	EXIT POINTS	CR PLAN	REFUEL ALTS UNIT	SCHED UNIT	ASSIGNED CENTRE	TIMES OF OPS
<b>AM24</b> 262412.0S 1564712.0E	262412.0S 1564712.0E	270106.0S 1572500.0E (AM24C) 125° 50NM	270106.0S 1572500.0E 264730.0S 1574130.0E 261036.0S 1570342.0E 262412.0S 1564712.0E	261036S 1570342E c. reserved d. reserved e. 33/96	a. 301.500 b. TBA c. reserved d. reserved e. 33/96	FL200/ FL300	33SQN OPS 0753610033		NOTAM

**AIRSPACE:** 271636.0S 1573106.0E (AMX205) - 261648.0S 1563124.0E (AMX206) - 255612.0S 1565630.0E (AMX207) - 265506.0S 1575700.0E (AMX208) - 271636.0S 1573106.0E (AMX205).  
**REMARKS:** Pattern size: 50NM x 20NM. Airspace size: 80NM x 30NM. No current procedure available for anchor. AAR operations outside Military controlled airspace.

<b>AM26</b> 304348.0S 1560036.0E	304348.0S 1560036.0E (AM26C) 017° 45NM	300312.0S 1562306.0E 295430.0S 1560218.0E 303506.0S 1553942.0E 304348.0S 1560036.0E	300312.0S 1562306.0E 1553942E c. reserved d. reserved e. 33/96	a. 301.500 b. TBA c. reserved d. reserved e. 33/96	FL200/ FL300	33SQN OPS 0753610033			TBA
--	--	--	---	--	-----------------	-------------------------	--	--	-----

**AIRSPACE:** 295142.0S 1563542.0E (AMX209) - 305936.0S 1555830.0E (AMX210) - 304630.0S 1552654.0E (AMX211) - 293842.0S 1560436.0E (AMX212) - 295142.0S 1563542.0E (AMX209).  
**REMARKS:** Pattern size: 45NM x 20NM. Airspace size: 75NM x 30NM. No current procedure available for anchor. AAR operations outside Military controlled airspace.

ENTRY POINTS	RVIP	ANCHOR PT/ IB COURSE/ PATTERN LEN	ANCHOR PATTERN	EXIT POINTS	CR PLAN	REFUEL ALTS	SCHED UNIT	ASSIGNED CENTRE	TIMES OF OPS
<b>AM28</b>	283530.0S 1494700.0E	274606.0S 1493748.0E (AM28C) 344° 50NM	274606.0S 1493748.0E 274918.0S 1491536.0E 283848.0S 1492436.0E 283530.0S 1494700.0E	283848.0S 1492436.0E	a. 301.500 b. TBA c. reserved d. reserved e. 33/96	FL200/ FL300	33SQN OPS 0753610033		NOTAM

**AIRSPACE:** 273512.0S 1490724.0E (AMX213) - 272942.0S 1494548.0E (AMX214) - 281000.0S 1494800.0E (AMX118) - 284900.0S 1495924.0E (AMX215) - 285424.0S 1492142.0E (AMX216) - 273512.0S 1490724.0E (AMX213).

**REMARKS:** Pattern size: 50NM x 20NM. Airspace size: 80NM x 30NM. No current procedure available for anchor. AAR operations outside Military controlled airspace.

<b>AM83</b>	254830.0S 1564106.0E	250012.0S 1555254.0E (AM83C) 305° 70NM	250012.0S 1555254.0E 251336.0S 1553624.0E 260200.0S 1562442.0E 254830.0S 1564106.0E	260200.0S 1562442.0E	N/A	FL260/ FL320	2SQN	Brisbane	TBA
-------------	-------------------------	--	--	-------------------------	-----	-----------------	------	----------	-----

**AIRSPACE:** 244542.0S 1554554.0E (AMX900) - 255612.0S 1566630.0E (AMX901) - 261648.0S 1563124.0E (AMX902) - 261548.0S 1563030.0E (AMX107) - 253990.0S 1555400.0E (AMX102) - 250654.0S 1551954.0E (AMX903) - 2444542.0S 1554554.0E (AMX900).

**REMARKS:** Pattern size: 70NM x 20NM. Airspace size: 100NM x 30NM.



ENTRY POINTS	RVIP	ANCHOR PT/ IB COURSE/ PATTERN LEN	ANCHOR PATTERN	EXIT POINTS	CR PLAN	REFUEL ALTS	SCHED UNIT	ASSIGNED CENTRE	TIMES OF OPS
AM84									
291012.0S	291012.0S	271754.0S	271754.0S	291324.0S	N/A	FL260/	2SQN	Brisbane	TBA
1495330.0E	1495330.0E	1493242.0E	1493242.0E	1493100.0E		FL320			
		(AM84C)	272106.0S						
		340°	1491030.0E						
		70NM	291324.0S						
			1493100.0E						
			291012.0S						
			1495330.0E						

**AIRSPACE:** 292806.0S 1492754.0E (AMX905) - 270348.0S 1490148.0E (AMX137) - 265736.0S 1494406.0E (AMX138) - 281000.0S 1494800.0E (AMX118) - 292212.0S 1500918.0E (AMX117) - 292806.0S 1492754.0E (AMX905).

**REMARKS:** Pattern size: 113NM x 20NM. Airspace size: 146NM x 30NM.

2.4 Darwin AAR and AEW&C airspace

ENTRY POINTS	RVIP	ANCHOR PT/ IB COURSE/ PATTERN LEN	ANCHOR PATTERN	EXIT POINTS	CR PLAN	REFUEL ALTS	SCHED UNIT	ASSIGNED CENTRE	TIMES OF OPS
DN81	102630.0S 1331236.0E	094524.0S 1321530.0E (DN81C) 302° 70NM	094524.0S 1321530.0E 100142.0S 1320336.0E 104248.0S 1330042.0E 102630.0S 1331236.0E	104248.0S 1330042.0E	N/A	FL260/ FL320	2SQN	Brisbane	TBA

**AIRSPACE:** 093230.0S 1320612.0E (DNX900) - 103118.0S 1332754.0E (DNX901) - 110436.0S 1330330.0E (DNX902) then along the minor arc of a circle radius 150.00NM centre 122524.0S 1305424.0E (DN/DME) - 100254.0S 1314354.0E (DNX903) - 093230.0S 1320612.0E (DNX900).

**REMARKS:** Pattern size: 70NM x 20NM. Airspace size: 100NM x 30NM.

DN82	145848.0S 1291712.0E	140900.0S 1282600.0E (DN82C) 312° 70NM	140900.0S 1282600.0E 142312.0S 1281130.0E 151306.0S 1290236.0E 145848.0S 1291712.0E	151306.0S 1290236.0E	N/A	FL260/ FL320	2SQN	Brisbane	TBA
------	-------------------------	--	--	-------------------------	-----	-----------------	------	----------	-----

**AIRSPACE:** 141600.0S 1275654.0E (DNX904) - 135024.0S 1282318.0E (DNX905) then along the minor arc of a circle radius 170.00NM centre 122524.0S 1305424.0E (DN/DME) - 145912.0S 1293836.0E (DNX906) - 152730.0S 1290954.0E (DNX907) - 141600.0S 1275654.0E (DNX904).

**REMARKS:** Pattern size: 70NM x 20NM. Airspace size: 100NM x 30NM.

ENTRY POINTS	RVIP	ANCHOR PT/ IB COURSE/ PATTERN LEN	ANCHOR PATTERN	EXIT POINTS	CR PLAN	REFUEL ALTS	SCHED UNIT	ASSIGNED CENTRE	TIMES OF OPS
DN83	131742.0S 1275854.0E	120730.0S 1275230.0E (DN83C)	120730.0S 1275230.0E 120918.0S 1273212.0E	131930.0S 1273830.0E	N/A	FL260/ FL320	2SQN	Brisbane	TBA
131742.0S 1275854.0E		352° 70NM	131930.0S 1273830.0E 131742.0S 1275842.0E						

**AIRSPACE:** 115442.0S 1272548.0E (DNX908) - 115118.0S 1280418.0E (DNX909) then along the minor arc of a circle radius 170.00NM centre 122524.0S 1305424.0E (DN/DME) - 133136.0S 1281354.0E (DNX910) - 133500.0S 1273442.0E (DNX911) - 115442.0S 1272548.0E (DNX908).

**REMARKS:** Pattern size: 70NM x 20NM. Airspace size: 100NM x 30NM.

2.5 EAXA AAR and AEW&C airspace

ENTRY POINTS	RVIP	ANCHOR PT/IB COURSE/PATTERN LEN	ANCHOR PATTERN	EXIT POINTS	CR PLAN	REFUEL ALTS	SCHED UNIT	ASSIGNED CENTRE	TIMES OF OPS
NW81	365906.0S 1521524.0E	360924.0S 1531654.0E (NW81C) 030° 70NM	360924.0S 1531654.0E 355518.0S 1525918.0E 364454.0S 1515742.0E 365906.0S 1521524.0E	364454.0S 1515748.0E	N/A	FL260/ FL320	2SQN	Brisbane	TBA

**AIRSPACE:** 360212.0S 1533412.0E (NWX900) - 3711312.0S 1520630.0E (NWX901) - 364618.0S 1513318.0E (NWX902) then along the minor arc of a circle radius 120.00NM centre 345700.0S 1503200.0E (NWA/TAC) - 352906.0S 1525306.0E (NWX903) - 360212.0S 1533412.0E (NWX900).

**REMARKS:** Pattern size: 70NM x 20NM. Airspace size: 100NM x 30NM.

NW82	364212.0S 1503706.0E	353224.0S 1502930.0E (NW82C) 342° 70NM	353224.0S 1502930.0E 353406.0S 1500506.0E 364354.0S 1501218.0E 364212.0S 1503706.0E	364354.0S 1501218.0E	N/A	FL260/ FL320	2SQN	Melbourne	TBA
------	-------------------------	--	--	-------------------------	-----	-----------------	------	-----------	-----

**AIRSPACE:** 351700.0S 1503412.0E (NWX904) - 365642.0S 1504500.0E (NWX905) - 365918.0S 1500736.0E (NWX906) - 351930.0S 1495730.0E (NWX907) - 351700.0S 1503412.0E (NWX904).

**REMARKS:** Pattern size: 70NM x 20NM. Airspace size: 100NM x 30NM.

2.6 Edinburgh AAR and AEW&C airspace

ENTRY POINTS	RVIP	ANCHOR PT/ IB COURSE/ PATTERN LEN	ANCHOR PATTERN	EXIT POINTS	CR PLAN	REFUEL ALTS	SCHED UNIT	ASSIGNED CENTRE	TIMES OF OPS
ED01	314500.0S 1444600.0E	303500.0S 1444500.0E (ED01C) 350° 70NM	303500.0S 1444500.0E 303448.0S 1441030.0E 314436.0S 1441106.0E 314500.0S 1444600.0E	314436.0S 1441106.0E	N/A	FL190/ FL240	33SQN	Melbourne	NOTAM

**AIRSPACE:** 3018'18.1S 14326'13.4E (EDX100) - 302123.9S 14521'43.3E (EDX101) - 320135.6S 1451905.1E (KADUV/WPT) - 315823.9S 1432132.8E (EDX102)

**REMARKS:** Pattern size: 70NM x 30NM. Airspace size: 100NM x 100NM.

2.7 Tindal AAR and AEW&C airspace

ENTRY POINTS	RVIP	ANCHOR PT/IB COURSE/PATTERN LEN	ANCHOR PATTERN	EXIT POINTS	CR PLAN	REFUEL ALTS	SCHED UNIT	ASSIGNED CENTRE	TIMES OF OPS
TN11 143812.0S 1323918.0E	143812.0S 1323918.0E	141530.0S 1321900.0E (TN11C) 315° 30NM	141530.0S 1321900.0E 142524.0S 1320718.0E 144806.0S 1322736.0E 143812.0S 1323918.0E	144806.0S 1322736.0E	a. 301.500 b. TBA c. reserved d. reserved e. 33/96	FL160/ FL190	33SQN OPS 0753610033	RAAF CRU (FREQ TBA) if R249 active, Brisbane (As assigned) if R249 Deactivated	NOTAM

**AIRSPACE:** A circle radius 27.50NM centre 143118.0S 1322242.0E (YPTN/AD).

**REMARKS:** Pattern exists within R249 (10000-NOTAM) remaining 2.5NM clear of boundary. Pattern size: 30NM x 15NM.

TN12 133530.0S 1312124.0E	133530.0S 1312124.0E	133542.0S 1304524.0E (TN12C) 266° 35NM	133542.0S 1304524.0E 135348.0S 1304530.0E 135348.0S 1312130.0E 133530.0S 1312124.0E	135348.0S 1312130.0E	a. 301.500 b. TBA c. reserved d. reserved e. 33/96	FL160/ FL190	33SQN OPS 0753610033	RAAF CRU (FREQ TBA) if R225A&B active, Brisbane (As assigned) if R225A&B Deactivated	NOTAM
---------------------------------	-------------------------	--	--	-------------------------	--	-----------------	-------------------------	---	-------

**AIRSPACE:** 140000.0S 1302224.0E (TNX101) - 132524.0S 1303542.0E (TNX102) then along the minor arc of a circle radius 62.50NM centre 122524.0S 1305424.0E (DN/DME) - 132136.0S 1312254.0E (TNX103) - 140000.0S 1314942.0E (TNX104) - 140000.0S 1302224.0E (TNX101).

**REMARKS:** Pattern exists within R225A&B (9500-NOTAM). Pattern size: 35NM x 18NM. Tanker to remain North of latitude S14 and South of 62.5DME DN.

ENTRY POINTS	RVIP	ANCHOR PT/ IB COURSE/ PATTERN LEN	ANCHOR PATTERN	EXIT POINTS	CR PLAN	REFUEL ALTS	SCHED UNIT	ASSIGNED CENTRE	TIMES OF OPS
TN81	144848.0S 1350618.0E	155506.0S 1344218.0E (TN81C) 195° 70NM	155506.0S 1344218.0E 160148.0S 1350154.0E 145512.0S 1352554.0E 144848.0S 1350618.0E	145512.0S 1352554.0E	N/A	FL260/ FL320	2SQN	Brisbane	TBA

**AIRSPACE:** 144230.0S 1353554.0E (TNX900) - 161736.0S 1350172.0E (TNX901) - 160500.0S 1342412.0E (TNX902) then along the minor arc of a circle radius 150.00NM centre 143118.0S 1322242.0E (YPTN/AD) - 143000.0S 1345718.0E (TNX903) - 144230.0S 1353554.0E (TNX900).

**REMARKS:** Pattern size: 70NM x 20NM. Airspace size: 100NM x 30NM.

TN82	165724.0S 1311348.0E	161354.0S 1301612.0E (TN82C) 304° 70NM	161354.0S 1301612.0E 162942.0S 1300318.0E 171312.0S 1310100.0E 165724.0S 1311348.0E	171312.0S 1310100.0E	N/A	FL260/ FL320	2SQN	Brisbane	TBA
------	-------------------------	--	--	-------------------------	-----	-----------------	------	----------	-----

**AIRSPACE:** 162418.0S 1294754.0E (TNX904) - 155342.0S 1301248.0E (TNX905) then along the minor arc of a circle radius 150.00NM centre 143118.0S 1322242.0E (YPTN/AD) - 165454.0S 1313542.0E (TNX906) - 172624.0S 1311012.0E (TNX907) - 162418.0S 1294754.0E (TNX904).

**REMARKS:** Pattern size: 70NM x 20NM. Airspace size: 100NM x 30NM.

ENTRY POINTS	RVIP	ANCHOR PT/ IB COURSE/ PATTERN LEN	ANCHOR PATTERN	EXIT POINTS	CR PLAN	REFUEL ALTS	SCHED UNIT	ASSIGNED CENTRE	TIMES OF OPS
TN83	144142.0S 1295812.0E	133548.0S 1302330.0E (TN83C) 017° 70NM	133548.0S 1302330.0E 132842.0S 1300418.0E 143436.0S 1293854.0E 144142.0S 1295812.0E	143424.0S 1293854.0E	N/A	FL260/ FL320	2SQN	Brisbane	TBA

**AIRSPACE:** 131254.0S 1300454.0E (TNX908) - 132324.0S 1303342.0E (TNX909) - 145730.0S 1295730.0E (TNX910) - 1444654.0S 1292836.0E (TNX911) - 131254.0S 1300454.0E (TNX908).

**REMARKS:** Pattern size: 70NM x 20NM. Airspace size: 100NM x 30NM.

TN84	170811.0S 1300552.0E	172433.0S 1300532.0E (TN84C) 087° 110NM	172433.0S 1300532.0E 172453.0S 1315950.0E 170724.0S 1315948.0E 170811.0S 1300552.0E	170724.0S 1315948.0E	N/A	FL260/ FL320	2SQN	Brisbane	TBA
------	-------------------------	---	--	-------------------------	-----	-----------------	------	----------	-----

**AIRSPACE:** 170146.0S 1294313.0E (TNX912) - 170153.0S 1322236.0E (TNX913) - 173154.0S 1322236.0E (TNX914) - 173154.0S 1294313.0E (TNX915) - 170146.0S 1294313.0E (TNX912)

**REMARKS:** Pattern size: 110NM x 20NM. Airspace size: 153NM x 30NM.



2.8 Townsville AAR and AEW&C airspace

ENTRY POINTS	RVP	ANCHOR PT/ IB COURSE/ PATTERN LEN	ANCHOR PATTERN	EXIT POINTS	CR PLAN	REFUEL ALTS	SCHED UNIT	ASSIGNED CENTRE	TIMES OF OPS
TL11 193136.0S 1454730.0E	193136.0S 1454730.0E	193612.0S 1450524.0E (TL11C) 256° 40NM	193612.0S 1450524.0E 195606.0S 1450748.0E 195130.0S 1454948.0E 193136.0S 1454730.0E	195130.0S 1454948.0E	a. 301.500 b. TBA c. reserved d. reserved e. 33/96	Within NOTAM vertical limits	33SQN OPS 0753610033	RAAF CRU (FREQ TBA) Brisbane (As assigned) if R737 Deactivated	NOTAM

**AIRSPACE:** 201154.0S 1445342.0E (TLX100) - 192642.0S 1443918.0E (TLX101) - 192154.0S 1453154.0E (TLX102) - 191900.0S 1460142.0E (TLX103) - 193500.0S 1460430.0E (TLX104) - 194506.0S 1461236.0E (TLX105) - 195200.0S 1463700.0E (TLX106) - 200112.0S 1455000.0E (TLX107) - 201154.0S 1445342.0E (TLX100).  
**REMARKS:** Pattern exists within R737A and R737B (7000-NOTAM). Pattern size: 40NM x 20NM. Check status of R741B (5000-NOTAM).

TL12 185530.0S 1454742.0E	185530.0S 1454742.0E	183406.0S 1451201.0E (TL12C) 295° 40NM	183406.0S 1451206.0E 185100.0S 1450048.0E 191230.0S 1453624.0E 185530.0S 1454747.0E	191230.0S 1453624.0E	a. 301.500 b. TBA c. reserved d. reserved e. 33/96	Within NOTAM vertical limits	33SQN OPS 0753610033	RAAF CRU (FREQ TBA) if R737 active, Brisbane (As assigned) if R737 Deactivated	NOTAM
---------------------------------	-------------------------	--	--	-------------------------	--	---------------------------------------	-------------------------	--	-------

**AIRSPACE:** 192642.0S 1443918.0E (TLX101) - 181430.0S 1445612.0E (TLX108) - 181812.0S 1451224.0E (TLX109) - 183836.0S 1454206.0E (TLX110) - 190600.0S 1461000.0E (TLX111) - 191900.0S 1460142.0E (TLX103) - 192154.0S 1453154.0E (TLX102) - 192642.0S 1443918.0E (TLX101).  
**REMARKS:** Pattern exists within R737C and R737D (7000-NOTAM). Pattern size: 40NM x 20NM.

ENTRY POINTS	RVIP	ANCHOR PT/ IB COURSE/ PATTERN LEN	ANCHOR PATTERN	EXIT POINTS	CR PLAN	REFUEL ALTS	SCHED UNIT	ASSIGNED CENTRE	TIMES OF OPS
TL81	194512.0S 1443454.0E	183506.0S 1443000.0E (TL81C)	183506.0S 1443000.0E 183624.0S 1440900.0E	194630.0S 1441342.0E	N/A	FL260/ FL320	2SQN	Brisbane	TBA
1443454.0E		349° 70NM	194630.0S 1441342.0E 194512.0S 1443454.0E						

**AIRSPACE:** 200200.0S 1440930.0E (TLX900) - 182130.0S 1440242.0E (TLX901) - 181754.0S 1445400.0E (TLX902) then along the minor arc of a circle radius 120.00NM centre 191442.0S 1464530.0E (TL/DME) - 195930.0S 1444730.0E (TLX903) - 200200.0S 1440930.0E (TLX900).

**REMARKS:** Pattern size: 70NM x 20NM. Airspace size: 100NM x 30NM.

2.9 Williamtown AAR and AEW&C airspace

ENTRY POINTS	RVIP	ANCHOR PT/ IB COURSE/ PATTERN LEN	ANCHOR PATTERN	EXIT POINTS	CR PLAN	REFUEL ALTS	SCHED UNIT	ASSIGNED CENTRE	TIMES OF OPS
WM11	310448.0S 310448.0S 1544818.0E	305542.0S 1535124.0E (WM11TC) 277° 50NM	305542.0S 1535124.0E 3111530.0S 1534700.0E 312442.0S 1544348.0E 310448.0S 1544818.0E	312442.0S 1544348.0E 1544818.0E	a. 301.500 b. TBA c. reserved d. reserved e. 33/96	FL130/ FL330	33SQN OPS 0753610033	RAAF CRU (REQ TBA) if M550D active. Brisbane (As assigned) if M550D Deactivated	NOTAM
<p><b>AIRSPACE:</b> 304333.0S 1532427.0E (WMX300) - 310443.0S 1553803.0E (WMX301) - 320101.0S 1550606.0E (WMX302) - 311724.0S 1530823.0E (WMX303) - 304333.0S 1532427.0E (WMX300)</p> <p><b>REMARKS:</b> Pattern exists within M550D. Pattern size: 50NM x 20NM.</p>									
WM18	315400.0S 315400.0S 1541742.0E	313400.0S 1532330.0E (WM18C) 281° 50NM	313400.0S 1532330.0E 315224.0S 1531406.0E 321218.0S 1540806.0E 315400.0S 1541742.0E	321218.0S 1540806.0E 1540806.0E 1541742.0E	a. 301.500 b. TBA c. reserved d. reserved e. 33/96	FL130/ FL330	33SQN OPS 0753610033	RAAF CRU (REQ TBA) if M550C active, Brisbane (As assigned) if M550C Deactivated	NOTAM
<p><b>AIRSPACE:</b> 311724.0S 1530823.0E (WMX303) - 320101.0S 1550606.0E (WMX302) - 325503.0S 1543446.0E (WMX304) - 322917.0S 1532440.0E (WMX305) - 321258.0S 1524130.0E (WMX306) - 311724.0S 1530823.0E (WMX303)</p> <p><b>REMARKS:</b> Pattern exists within R574 (G) (SFC-FL600). Pattern size: 40NM x 20NM.</p>									

ENTRY POINTS	RVP	ANCHOR PT/ IB COURSE/ PATTERN LEN	ANCHOR PATTERN	EXIT POINTS	CR PLAN	REFUEL ALTS	SCHED UNIT	ASSIGNED CENTRE	TIMES OF OPS
WM19	320754.0S 1531318.0E	314006.0S 1532642.0E (WM19C) 010° 30NM	314006.0S 1532642.0E 313424.0S 1531030.0E 320206.0S 1525700.0E 320754.0S 1531318.0E	320206.0S 1525700.0E 1525700.0E	a. 301.500 b. TBA c. reserved d. reserved e. 33/96	FL130/ FL330	33SQN OPS 0753610033	RAAF CRU (FREQ TBA) if M550C active, Brisbane (As assigned) if M550C Deactivated	NOTAM

**AIRSPACE:** 311724.0S 1530823.0E (WMX303) - 320101.0S 1550606.0E (WMX302) - 325503.0S 1543446.0E (WMX304) - 322917.0S 1532440.0E (WMX305) - 321258.0S 1524130.0E (WMX306) - 311724.0S 1530823.0E (WMX303)

**REMARKS:** Pattern exists within M550C. Pattern size: 30NM x 15NM.

WM20	332048.0S 1524624.0E	323918.0S 1530700.0E (WM20C) 010° 45NM	323918.0S 1530700.0E 323324.0S 1525042.0E 331500.0S 1522954.0E 332048.0S 1524624.0E	331500.0S 1522954.0E 1525042.0E 331500.0S 1522954.0E	a. 301.500 b. TBA c. reserved d. reserved e. 33/96	FL130/ FL330	33SQN OPS 0753610033	RAAF CRU (FREQ TBA) if M550A active, Brisbane (As assigned) if M550A Deactivated	NOTAM
------	-------------------------	--	--	--	--	-----------------	-------------------------	---	-------

**AIRSPACE:** 321258.0S 1524130.0E (WMX306) - 322917.0S 1532440.0E (WMX305) - 334906.0S 1524538.0E (WMX307) - 334854.0S 1520641.0E (WMX308) - 333926.0S 1520206.0E (WMX309) - 331154.0S 1515814.0E (WMX310) - Then along the counter clockwise arc of a circle radius 25.00NM centre WLM TAC 324750.0S 1514959.0E (WMX311) - 324219.0S 1521854.0E (WMX312) - 324038.0S 1522734.0E (WMX313) - 321258.0S 1524130.0E (WMX306)

**REMARKS:** Pattern exists within M550A. Pattern size: 45NM x 15NM.

ENTRY POINTS	RVP	ANCHOR PT/IB COURSE/PATTERN LEN	ANCHOR PATTERN	EXIT POINTS	CR PLAN	REFUEL ALTS	SCHED UNIT	ASSIGNED CENTRE	TIMES OF OPS
WM21	333654.0S 1535724.0E	330518.0S 1541512.0E (WM21C) 012° 35NM	330518.0S 1541512.0E 325848.0S 1535906.0E 333030.0S 1534112.0E 333654.0S 1535724.0E	333030.0S 1534112.0E	a. 301.500 b. TBA c. reserved d. reserved e. 33/96	FL130/ FL330	33SQN OPS 0753610033	RAAF CRU (FREQ TBA) if M550B active, Brisbane (As assigned) if M550B Deactivated	NOTAM

**AIRSPACE:** 322917.0S 1532440.0E (WMX305) - 325503.0S 1543446.0E (WMX304) - 334855.0S 1540250.0E (WMX314) - 334906.0S 1524538.0E (WMX307) - 322917.0S 1532440.0E (WMX305)

**REMARKS:** Pattern exists within M550B. Pattern size: 35NM x 15NM.

WM22	322200.0S 1500812.0E	315736.0S 1503730.0E (WM22C) 034° 35NM	315736.0S 1503730.0E 314436.0S 1502248.0E 320906.0S 1495318.0E 322200.0S 1500812.0E	320906.0S 1495318.0E	a. 301.500 b. TBA c. reserved d. reserved e. 33/96	A100/ FL220	33SQN OPS 0753610033	RAAF CRU (FREQ TBA) if R560 active, Brisbane (As assigned) if R560 Deactivated	NOTAM
------	-------------------------	--	--	-------------------------	--	----------------	-------------------------	---	-------

**AIRSPACE:** 320236.0S 1490547.0E (WMX401) - 321329.0S 1492125.0E (WMX402) - 322745.0S 1494203.0E (WMX403) - 324315.0S 1495932.0E (WMX404) - 320827.0S 1504205.0E (WMX405) - 320243.0S 1505208.0E (WMX406) - 315350.0S 1505254.0E (WMX407) - 314710.0S 1504945.0E (WMX408) - 313029.0S 1504156.0E (WMX409) - 312442.0S 1503707.0E (WMX410) - 310811.0S 1502326.0E (WMX411) - 314535.0S 1494048.0E (WMX412) - 320236.0S 1490547.0E (WMX401)

**REMARKS:** Pattern exists within R560A (8500-FL240) and R560B. Pattern size: 35NM x 18NM.

ENTRY POINTS	RVP	ANCHOR PT/IB COURSE/PATTERN LEN	ANCHOR PATTERN	EXIT POINTS	CR PLAN	REFUEL ALTS	SCHED UNIT	ASSIGNED CENTRE	TIMES OF OPS
WM23	311024.0S	304542.0S	304542.0S	305436.0S	a. 301.500	FL120/	33SQN OPS	RAAF CRU	NOTAM
311024.0S	1492500.0E	1500148.0E	1500148.0E	1491036.0E	b. TBA	FL330	0753610033	(FREQ TBA)	
1492500.0E		(WM23C)	303006.0S		c. reserved			if R570A	
		041°	1494718.0E		d. reserved			active.	
		40NM	305436.0S		e. 33/96			Brisbane (As assigned) if R570A	
			1491036.0E					Deactivated	
			311024.0S						
			1492500.0E						

**AIRSPACE:** 304714.0S 1485813.0E (WMX413) - 300647.0S 1500449.0E (WMX414) - 310811.0S 1502326.0E (WMX411) - 314535.0S 1494048.0E (WMX412) - 315822.0S 1491434.0E (WMX415) - 315126.0S 1490439.0E (WMX416) - 304714.0S 1485813.0E (WMX413)

**REMARKS:** Pattern exists within R570A. Pattern size: 40NM x 20NM.

WM87	323212.0S	312848.0S	312848.0S	322336.0S	N/A	FL260/	2SQN	Brisbane	TBA
323212.0S	1551712.0E	1555206.0E	1555206.0E	1545548.0E		FL320			
1551712.0E		(WM87C)	312012.0S						
		012°	1553100.0E						
		70NM	322336.0S						
			1545548.0E						
			323212.0S						
			1551712.0E						

**AIRSPACE:** 310443.0S 1553803.0E (WMX926) - 311153.0S 1561323.0E (WMX927) - 324648.0S 1552030.0E (WMX910) - 323824.0S 1544512.0E (WMX911) - 310443.0S 1553803.0E (WMX926)

**REMARKS:** Pattern size: 70NM X 20NM. Airspace size: 100NM x 30NM.

ENTRY POINTS	RVIP	ANCHOR PT/ IB COURSE/ PATTERN LEN	ANCHOR PATTERN	EXIT POINTS	CR PLAN	REFUEL ALTS	SCHED UNIT	ASSIGNED CENTRE	TIMES OF OPS
WM88	294324.0S 1490242.0E	294242.0S 1494236.0E (WM88C) 078° 35NM	294242.0S 1494236.0E 292242.0S 1494206.0E 292318.0S 1490206.0E 294324.0S 1490242.0E	292318.0S 1490206.0E	N/A	FL260/ FL320	33SQN POS 0753610033	Brisbane	TBA

**AIRSPACE:** 294813.0S 1485603.0E (WMX931) - 291720.0S 1485356.0E (WMX932) - 291703.0S 1494911.0E (WMX933) - 294725.0S 1495046.0E (WMX934) - 294813.0S 1485603.0E (WMX931)  
**REMARKS:** Pattern size: 35NM x 20NM. Airspace size: 50NM x 30NM.

WM89	332200.0S 1544912.0E	320036.0S 1553442.0E (WM89C) 012° 90NM	320036.0S 1553442.0E 315200.0S 1551330.0E 331324.0S 1542742.0E 332200.0S 1544912.0E	331324.0S 1542742.0E	N/A	FL260/ FL320	2SQN	Brisbane	TBA
------	-------------------------	--	--	-------------------------	-----	-----------------	------	----------	-----

**AIRSPACE:** 313951.0S 1551809.0E (WMX929) - 315154.0S 1555732.0E (WMX930) - 334036.0S 1545524.0E (WMX923) - 332742.0S 1541612.0E (WMX924) - 313951.0S 1551809.0E (WMX929)  
**REMARKS:** Pattern size: 90NM x 20NM. Airspace size: 118NM x 33NM.

ENTRY POINTS	RVIP	ANCHOR PT/ IB COURSE/ PATTERN LEN	ANCHOR PATTERN	EXIT POINTS	CR PLAN	REFUEL ALTS	SCHED UNIT	ASSIGNED CENTRE	TIMES OF OPS
WM92	304406.0S	305642.0S	305642.0S	302418.0S	N/A	FL260/ FL320	2SQN	Brisbane	TBA
304406.0S	1534318.0E	1550200.0E	1550200.0E	1534642.0E					
1534318.0E		(WM92C)	303654.0S						
		098°	1550518.0E						
		70NM	302418.0S						
			1534642.0E						
			304406.0S						
			1534318.0E						

**AIRSPACE:** 304330.0S 1532430.0E (WMX904) - 301854.0S 1532930.0E (WMX905) - 302812.0S 1542554.0E (WMX906) - 303824.0S 1553124.0E (WMX907) - 310142.0S 1551812.0E (WMX908) - 304330.0S 1532430.0E (WMX904).

**REMARKS:** Pattern size: 70NM x 20NM. Airspace size: 100NM x 30NM.

WM93	334936.0S	324612.0S	324612.0S	334100.0S	N/A	FL260/ FL320	2SQN	Brisbane	TBA
334936.0S	1543812.0E	1551336.0E	1551336.0E	1541630.0E					
1543812.0E		(WM93C)	323736.0S						
		012°	1545212.0E						
		70NM	334100.0S						
			1541630.0E						
			334936.0S						
			1543812.0E						

**AIRSPACE:** 322145.0S 1545452.0E (WMX928) - 323454.0S 1552642.0E (WMX914) - 340454.0S 1543412E (WMX915) - 335130S 1540154E (WMX916) - 322145.0S 1545452.0E (WMX928)

**REMARKS:** Pattern size: 70NM x 20NM. Airspace size: 100NM x 30NM.



ENTRY POINTS	RVIP	ANCHOR PT/ IB COURSE/ PATTERN LEN	ANCHOR PATTERN	EXIT POINTS	CR PLAN	REFUEL ALTS	SCHED UNIT	ASSIGNED CENTRE	TIMES OF OPS
WM94 315348.0S 1524248.0E	315348.0S 1524248.0E	311836.0S 1525936.0E (WM93C) 010° 38NM	311836.0S 1525936.0E 311336.0S 1524536.0E 314848.0S 1522842.0E 315348.0S 1524248.0E	314848.0S 1522842.0E	N/A	FL260/ FL340	2SQN	Brisbane	TBA

**AIRSPACE:** 310014.0S 1524826.0E (WMX315) - 310021.0S 1531630.0E (WMX316) - 311724.0S 1530823.0E (WMX303) - 320152.0S 1524655.0E (WMX317) - 320215.0S 1522513.0E (WMX318) - 320219.0S 1522105.0E (WMX319) - 320323.0S 1521746.0E (WMX320) - 313320.0S 1522706.0E (WMX321) - 310014.0S 1524826.0E (WMX315)

**REMARKS:** Pattern exists within R586C (FL125-FL600 NOTAM). Pattern size: 38NM x 13NM.

## 3. MILITARY AAR AND AEW&amp;C AIRSPACE ANCHOR WAYPOINTS

## 3.1 Amberley

WPT	LAT	LONG	WPT	LAT	LONG
AMX100	261542.0S	1532954.0E	AMX200	250654.0S	1551954.0E
AMX101	244942.0S	1550206.0E	AMX201	244942.0S	1550206.0E
AMX102	253930.0S	1555400.0E	AMX202	240824.0S	1541948.0E
AMX103	264642.0S	1535330.0E	AMX203	234554.0S	1544730.0E
AMX104	274630.0S	1544430.0E	AMX204	244542.0S	1554554.0E
AMX105	271312.0S	1544430.0E	AMX205	271636.0S	1573106.0E
AMX106	263324.0S	1554654.0E	AMX206	261648.0S	1563124.0E
AMX107	261548.0S	1563030.0E	AMX207	255612.0S	1565630.0E
AMX108	271636.0S	1573106.0E	AMX208	265506.0S	1575700.0E
AMX109	285012.0S	1563754.0E	AMX209	295142.0S	1563542.0E
AMX110	285212.0S	1534942.0E	AMX210	305936.0S	1555818.0E
AMX111	282912.0S	1535736.0E	AMX211	304630.0S	1552654.0E
AMX112	283348.0S	1540918.0E	AMX212	293848.0S	1560436.0E
AMX113	291324.0S	1550712.0E	AMX213	273512.0S	1490724.0E
AMX114	302812.0S	1542554.0E	AMX214	272942.0S	1494548.0E
AMX115	301854.0S	1532930.0E	AMX215	284900.0S	1495924.0E
AMX116	293924.0S	1533736.0E	AMX216	285424.0S	1492142.0E
AMX117	292212.0S	1500918.0E	AMX900	244542.0S	1554554.0E
AMX118	281000.0S	1494800.0E	AMX901	255612.0S	1565630.0E
AMX125	282830.0S	1495324.0E	AMX902	261648.0S	1563124.0E
AMX126	280830.0S	1510336.0E	AMX903	250654.0S	1551954.0E
AMX127	281942.0S	1510848.0E	AMX905	292806.0S	1492754.0E
AMX128	283530.0S	1512036.0E	AM11C	260606.0S	1544800.0E
AMX129	284430.0S	1512942.0E	AM13C	270654.0S	1555418.0E
AMX130	265736.0S	1494406.0E	AM15C	292430.0S	1544042.0E
AMX131	271742.0S	1505342.0E	AM17C	285218.0S	1501254.0E
AMX132	272830.0S	1505306.0E	AM19C	274112.0S	1504512.0E
AMX133	274500.0S	1505536.0E	AM22C	245112.0S	1551424.0E
AMX134	280106.0S	1510012.0E	AM24C	270106.0S	1572500.0E
AMX135	280830.0S	1510336.0E	AM26C	300312.0S	1562306.0E
AMX136	282830.0S	1495324.0E	AM28C	274918.0S	1491536.0E
AMX137	270348.0S	1490148.0E	AM83C	250012.0S	1555254.0E
AMX138	265736.0S	1494406.0E	AM84C	291324.0S	1493100.0E

3.2 Darwin

WPT	LAT	LONG	WPT	LAT	LONG
DNX900	093230.0S	1320612.0E	DNX908	115442.0S	1272548.0E
DNX901	103118.0S	1332754.0E	DNX909	115118.0S	1280418.0E
DNX902	110436.0S	1330330.0E	DNX910	133136.0S	1281354.0E
DNX903	100254.0S	1314354.0E	DNX911	133500.0S	1273442.0E
DNX904	141600.0S	1275654.0E	DN81C	094524.0S	1321530.0E
DNX905	135024.0S	1282318.0E	DN82C	140900.0S	1282600.0E
DNX906	145912.0S	1293836.0E	DN83C	120730.0S	1275230.0E
DNX907	152718.0S	1290954.0E			

3.3 EAXA

WPT	LAT	LONG	WPT	LAT	LONG
NWX900	360212.0S	1533412.0E	NWX905	365642.0S	1504500.0E
NWX901	371312.0S	1520630.0E	NWX906	365918.0S	1500736.0E
NWX902	364618.0S	1513318.0E	NWX907	351930.0S	1495730.0E
NWX903	352906.0S	1525306.0E	NW81C	360924.0S	1531654.0E
NWX904	351700.0S	1503412.0E	NW82C	353224.0S	1502930.0E

3.4 Edinburgh

WPT	LAT	LONG	WPT	LAT	LONG
EDX100	301818.1S	1432613.4E	ED01C	303448.0S	1444454.0E
KADUV	320135.6S	1451905.1E	EDX102	315823.9S	1432132.8E
EDX101	302123.9S	1452143.3E			

3.5 Tindal

WPT	LAT	LONG	WPT	LAT	LONG
TNX101	140000.0S	1302224.0E	TNX909	132324.0S	1303342.0E
TNX102	132524.0S	1303542.0E	TNX910	145730.0S	1295730.0E
TNX103	132136.0S	1312254.0E	TNX911	144654.0S	1292836.0E
TNX104	140000.0S	1314942.0E	TNX912	170146.0S	1294313.0E
TNX900	144230.0S	1353554.0E	TNX913	170153.0S	1322236.0E
TNX901	161736.0S	1350142.0E	TNX914	173154.0S	1322236.0E
TNX902	160500.0S	1342412.0E	TNX915	173154.0S	1294313.0E

TNX903	143000.0S	1345718.0E	TN11C	141530.0S	1321900.0E
TNX904	162418.0S	1294754.0E	TN12C	133542.0S	1304524.0E
TNX905	155342.0S	1301248.0E	TN81C	155506.0S	1344218.0E
TNX906	165454.0S	1313542.0E	TN82C	161354.0S	1301612.0E
TNX907	172624.0S	1311012.0E	TN83C	133548.0S	1302330.0E
TNX908	131254.0S	1300454.0E			

## 3.6 Townsville

WPT	LAT	LONG	WPT	LAT	LONG
TLX100	201154.0S	1445342.0E	TLX110	183836.0S	1454206.0E
TLX101	192642.0S	1443918.0E	TLX111	190600.0S	1461000.0E
TLX102	192154.0S	1453154.0E	TLX900	200200.0S	1440930.0E
TLX103	191900.0S	1460142.0E	TLX901	182130.0S	1440242.0E
TLX104	193500.0S	1460430.0E	TLX902	181754.0S	1445400.0E
TLX105	194506.0S	1461236.0E	TLX903	195930.0S	1444730.0E
TLX106	195200.0S	1463700.0E	TL11C	193612.0S	1450524.0E
TLX107	200112.0S	1455000.0E	TL12C	183406.0S	1451206.0E
TLX108	181430.0S	1445612.0E	TL81C	183506.0S	1443000.0E
TLX109	181812.0S	1451224.0E			

## 3.7 Williamtown

WPT	LAT	LONG	WPT	LAT	LONG
WM11C	305542.0S	1535124.0E	WMX302	320101.0S	1550606.0E
WM18C	313400.0S	1532330.0E	WMX303	311724.0S	1530823.0E
WM19C	314006.0S	1532642.0E	WMX304	325503.0S	1543446.0E
WM20C	323918.0S	1530700.0E	WMX305	322917.0S	1532440.0E
WM21C	330518.0S	1541512.0E	WMX306	321258.0S	1524130.0E
WM22C	315736.0S	1503730.0E	WMX307	334906.0S	1524538.0E
WM23C	311024.0S	1492500.0E	WMX308	334854.0S	1520641.0E
WM87C	312848.0S	1555206.0E	WMX309	333926.0S	1520206.0E
WM88C	294242.0S	1494236.0E	WMX310	331154.0S	1515814.0E
WM89C	320036.0S	1553442.0E	WMX311	324750.0S	1514959.0E
WM92C	305642.0S	1550200.0E	WMX312	324219.0S	1521854.0E
WM93C	324612.0S	1551336.0E	WMX313	324038.0S	1522734.0E
WMX300	304333.0S	1532427.0E	WMX314	334855.0S	1540250.0E
WMX301	310443.0S	1553803.0E	WMX315	310014.0S	1524826.0E

WMX316	310021.0S	1531630.0E	WMX900	320400.0S	1521700.0E
WMX317	320152.0S	1524655.0E	WMX901	310412.0S	1524706.0E
WMX318	320215.0S	1522513.0E	WMX902	311112.0S	1530624.0E
WMX319	320219.0S	1522105.0E	WMX903	321106.0S	1523630.0E
WMX320	320323.0S	1521746.0E	WMX904	304330.0S	1532430.0E
WMX321	313320.0S	1522706.0E	WMX905	301854.0S	1532930.0E
WMX401	320236.0S	1490547.0E	WMX906	302812.0S	1542554.0E
WMX402	321329.0S	1492125.0E	WMX907	303824.0S	1553124.0E
WMX403	322745.0S	1494203.0E	WMX908	310142.0S	1551812.0E
WMX404	324315.0S	1495932.0E	WMX910	324648.0S	1552030.0E
WMX405	320827.0S	1504205.0E	WMX911	323824.0S	1544512.0E
WMX406	320243.0S	1505208.0E	WMX914	323454.0S	1552642.0E
WMX407	315350.0S	1505254.0E	WMX915	340454.0S	1543412.0E
WMX408	314710.0S	1504945.0E	WMX916	335130.0S	1540154.0E
WMX409	313029.0S	1504156.0E	WMX923	334036.0S	1545524.0E
WMX410	312442.0S	1503707.0E	WMX924	332742.0S	1541612.0E
WMX411	310811.0S	1502326.0E	WMX926	310443.0S	1553803.0E
WMX412	314535.0S	1494048.0E	WMX927	311153.0S	1561323.0E
WMX413	304714.0S	1485813.0E	WMX928	322145.0S	1545452.0E
WMX414	300647.0S	1500449.0E	WMX929	313951.0S	1551809.0E
WMX415	315822.0S	1491434.0E	WMX930	315154.0S	1555732.0E
WMX416	315126.0S	1490439.0E	WMX931	294813.0S	1485603.0E
			WMX932	291720.0S	1485356.0E
			WMX933	291703.0S	1494911.0E
			WMX934	294725.0S	1495046.0E

4. MILITARY AAR TRACK WAYPOINTS

WPT	LAT/LONG	TR OUT(°M)	DIST (NM)
<b>W946</b>			
AGETA	300143.1S 1480742.3E	301	
CARBN	290721.8S 1465807.3E	303	81
CMU	280205.2S 1453725.5E	313	96
EXXON	254636.0S 1433906.0E	314	172
VALDZ	232700.0S 1414148.0E	316	175
MA	203952.6S 1392908.3E	305	207
TEXAN	190042.0S 1372924.0E	306	150
PETRL	171216.0S 1352134.5E	308	163
GUVKI	161454.0S 1341536.0E	309	85
TN	143109.1S 1322215.6E		151
<b>W951</b>			
ROM	263235.1S 1484654.1E	285	
ESLES	255831.1S 1472326.5E	286	82
LIDBU	244524.5S 1443301.5E	288	171
VALDZ	232700.0S 1414148.0E		175
<b>W952</b>			
AMOCO	240000.0S 1521230.0E	328	
KELPI	223410.2S 1513511.6E	332	92
BOOMA	200000.0S 1504112.0E	333	162
LAMEK	180916.6S 1500235.5E	334	116
CALTX	170000.0S 1493913.7E		73
<b>W953</b>			
NOBIP	170000.0S 1501754.0E	154	
ORIGA	180918.0S 1504206.0E	154	73
GASSO	200000.0S 1512024.0E	152	116
VEGDI	223418.0S 1521850.0E	151	163
DOLKO	240000.0S 1525218.0E		91
<b>W954</b>			
CFS	301910.2S 1530715.2E	093	
GALON	303804.7S 1543200.4E	092	76
POSUM	310553.3S 1564700.5E	090	119
LHI	313144.1S 1590422.6E	088	120
LADUR	314400.0S 1601430.0E		61

ENR 5

5. MILITARY AAR AND AEW&C PATTERNS

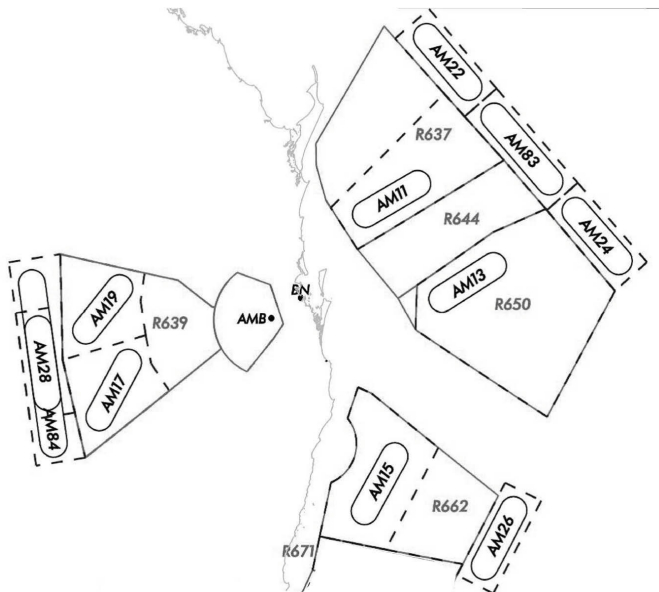

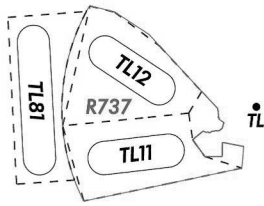
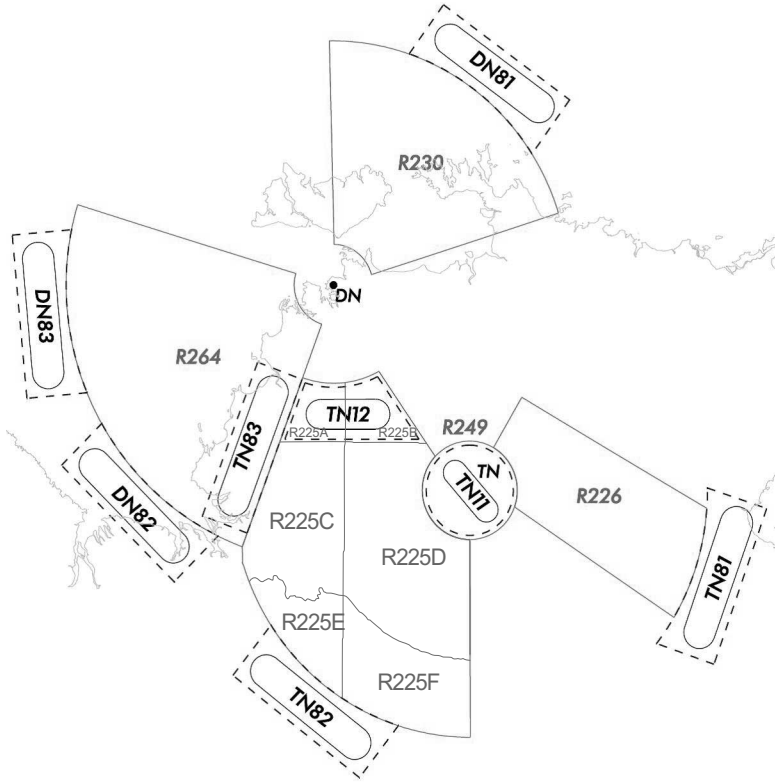



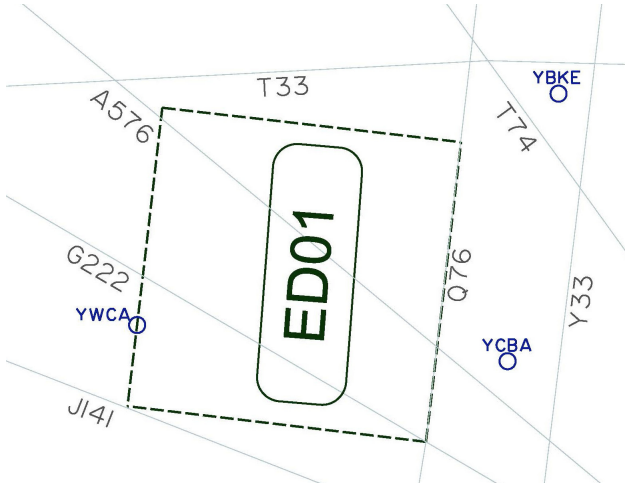

6. REFUELLING TRACKS

RVIP	RVCP	NAV CHK POINTS	EXIT	CR PLAN	REFUELLING ALTITUDES	SCHED UNIT	ASSIGNED CENTRE
<b>W946 (North)</b>							
AGEA 300143.1S 1480742.3E	CARBN 290721.8S 1466807.3E	CMU 280205.2S 1453725.5E EXXON 254636.0S 1433906.0E VALDZ 232700.0S 1414148.0E MA 203952.6S 1392908.3E TEXAN 190042.0S 1372924.0E PETRL 171216.0S 1352134.5E	GUVKI 161454.0S 1341536.0E	a. 301.500 b. TBA c. reserved d. reserved e. 33/96	FL250/FL300	33SQN OPS 07 5361 0033	Brisbane (FREQ as assigned)
<b>REMARKS:</b> Simultaneous Opposite Direction Refuelling operations are authorised on W946.							

RVIP	RVCP	NAV CHK POINTS	EXIT	CR PLAN	REFUELLING ALTITUDES	SCHED UNIT	ASSIGNED CENTRE
<b>W946 (South)</b>							
GUVKI 161454.0S 1341536.0E	PETRL 171216.0S 1352134.5E	TEXAN 190042.0S 1372924.0E MA 203952.6S 1392908.3E VALDZ 232700.0S 1414148.0E EXXON 254636.0S 1433906.0E CMU 280205.2S 1453725.5E CARBN 290721.8S 1465807.3E	AGETA 300143.1S 1480742.3E	a. 301.500 b. TBA c. reserved d. reserved e. 33/96	FL250/FL300	33SQN OPS 07 5361 0033	Brisbane (FREQ as assigned)
<b>REMARKS:</b> Simultaneous Opposite Direction Refuelling operations are authorised on W946.							

RVIP	RVCP	NAV CHK POINTS	EXIT	CR PLAN	REFUELLING ALTITUDES	SCHED UNIT	ASSIGNED CENTRE
<b>W951 (West)</b>							
ROM 263235.1S 1484654.1E	ESLES 255831.1S 1472326.5E	LIDBU 244524.5S 1443301.5E	VALDZ 232700.0S 1414148.0E	a. 301.500 b. TBA c. reserved d. reserved e. 33/96	FL250/FL300	33SQN OPS 07 5361 0033	Brisbane (REQ as assigned)
<b>REMARKS:</b> Simultaneous Opposite Direction Refuelling operations are authorised on W951. Track refuelling may continue on W946 if required.							
<b>W951 (East)</b>							
VALDZ 232700.0S 1414148.0E	LIDBU 244524.5S 1443301.5E	ESLES 255831.1S 1472326.5E	ROM 263235.1S 1484654.1E	a. 301.500 b. TBA c. reserved d. reserved e. 33/96	FL250/FL300	33SQN OPS 07 5361 0033	Brisbane (REQ as assigned)
<b>REMARKS:</b> Simultaneous Opposite Direction Refuelling operations are authorised on W951.							

RVIP	RVCP	NAV CHK POINTS	EXIT	CR PLAN	REFUELLING ALTITUDES	SCHED UNIT	ASSIGNED CENTRE
<b>W952 (North)</b>							
AMOCO 240000.0S 1521230.0E	KELPI 223410.2S 1513511.6E	BOOMA 200000.0S 1504112.0E LAMEK 180916.6S 1500235.5E	CALT 170000.0S 1493913.7E	a. 301.500 b. TBA c. reserved d. reserved e. 33/96	FL250/FL300	33SQN OPS 07 5361 0033	Brisbane (FREQ as assigned)
<b>REMARKS:</b> Track runs parallel to W953.							
<b>W952 (South)</b>							
CALT 170000.0S 1493913.7E	LAMEK 180916.6S 1500235.5E	BOOMA 200000.0S 1504112.0E KELPI 223410.2S 1513511.6E	AMOCO 240000.0S 1521230.0E	a. 301.500 b. TBA c. reserved d. reserved e. 33/96	FL250/FL300	33SQN OPS 07 5361 0033	Brisbane (FREQ as assigned)
<b>REMARKS:</b> Track runs parallel to W953.							

RVIP	RVCP	NAV CHK POINTS	EXIT	CR PLAN	REFUELLING ALTITUDES	SCHED UNIT	ASSIGNED CENTRE
<b>W953 (South)</b>							
NOBIP 170000.0S 1501754.0E	ORIGA 180918.0S 1504206.0E	GASSO 200000.0S 1512024.0E VEGDI 223418.0S 1521850.0E	DOLKO 240000.0S 1525218.0E	a. 301.500 b. TBA c. reserved d. reserved e. 33/96	FL250/FL300	33SQN OPS 07 5361 0033	Brisbane (FREQ as assigned)
<b>REMARKS:</b> Track runs parallel to W952.							
<b>W953 (North)</b>							
DOLKO 240000.0S 1525218.0E	VEGDI 223418.0S 1521850.0E	GASSO 200000.0S 1512024.0E ORIGA 180918.0S 1504206.0E	NOBIP 170000.0S 1501754.0E	a. 301.500 b. TBA c. reserved d. reserved e. 33/96	FL250/FL300	33SQN OPS 07 5361 0033	Brisbane (FREQ as assigned)
<b>REMARKS:</b> Track runs parallel to W952.							

RVIP	RVCP	NAV CHK POINTS	EXIT	CR PLAN	REFUELLING ALTITUDES	SCHED UNIT	ASSIGNED CENTRE
<b>W954 (East)</b>							
CFS 301910.2S 1530715.2E	GALON 303804.7S 1543200.4E	POSUM 310553.3S 1564700.5E LHI 313144.1S 1590422.6E	LADUR 314400.0S 1601430.0E	a. 301.500 b. TBA c. reserved d. reserved e. 33/96	FL250/FL300	33SQN OPS 07 5361 0033	Brisbane (FREQ as assigned)
<b>REMARKS:</b> Simultaneous Opposite Direction Refuelling operations are authorised on W954.							
<b>W954 (West)</b>							
LADUR 314400.0S 1601430.0E	LHI 313144.1S 1590422.6E	POSUM 310553.3S 1564700.5E GALON 303804.7S 1543200.4E	CFS 301910.2S 1530715.2E	a. 301.500 b. TBA c. reserved d. reserved e. 33/96	FL250/FL300	33SQN OPS 07 5361 0033	Brisbane (FREQ as assigned)
<b>REMARKS:</b> Simultaneous Opposite Direction Refuelling operations are authorised on W954.							

**7. PROCEDURES FOR AIRCRAFT OPERATING IN AN AIR DEFENCE IDENTIFICATION ZONE**

7.1 General

7.1.1 The following general rules and procedures apply to enable identification of air traffic entering any designated Air Defence Identification Zone (ADIZ) under the control of Australia.

7.1.2 An ADIZ is airspace of defined dimensions within which identification of all aircraft is required.

7.1.3 When a flight is intended to operate within an ADIZ, the pilot, unless exempted in accordance with para 7.1.4, must:

- a. lodge a flight notification covering flight within the ADIZ with the appropriate ATS unit at least 60 minutes before entry into the ADIZ;
- b. report position to ATS when passing each position reporting point within the ADIZ;
- c. report position to ATS at ADIZ boundary with a geographical reference (e.g. 15NM east of...) or, if the departure point is within 100NM of the ADIZ boundary, report departure;
- d. report departure if departing from a point in the ADIZ;

- e. maintain a continuous listening watch on the communications frequency of the appropriate ATS unit or on another frequency as directed until the flight is through the ADIZ;
- f. not deliberately deviate from tracks and altitudes filed in the flight notification unless prior ATC clearance is obtained, or, outside controlled airspace, notification is given to the appropriate ATS unit; and
- g. activate the aircraft transponder when within 100NM of the ADIZ and when operating within the ADIZ.

7.1.4 The following flights over Australia and its territorial waters are exempted from compliance with the requirements of para 7.1.3:

- a. a flight originating within an ADIZ which maintains a steady outbound track;
- b. a flight which remains within 10NM of the point of departure;
- c. aircraft performing published approach, holding or recovery procedures; and
- d. a flight conducted in accordance with special procedures arranged with the Regional Air Defence Commander.

7.1.5 Flight notifications lodged in accordance with para 7.1.3 must include details of:

- a. tracks and altitudes to be flown while operating in the ADIZ;
- b. estimated elapsed times for each route segment in the ADIZ, including the segment in which the ADIZ boundary is crossed;
- c. position reporting points, departure and landing points; and
- d. estimated time at the commencing point of the first route segment for which details are required in accordance with sub-para b.

7.1.6 Reporting points published in aeronautical charts must be used plus those required by the Regional Air Defence Commander.

7.1.7 Pilots must immediately notify ATS of any deviation from flight notification beyond the following tolerances:

- a. estimated time of commencing the ADIZ route segments –  $\pm$  5 minutes;
- b. over land area –  $\pm$  10NM from track;
- c. over oceanic areas –  $\pm$  20NM from track.

*Note: The 5 minutes expressed in sub-para a. will be used in considering an appropriate response, but pilots must report predicted deviations of greater than two (2) minutes.*

7.1.8 In the event of failure of two way radio communication, the pilot must proceed in accordance with the normal radio failure procedures.

## 7.2 Special Requirements

7.2.1 Special requirements may be published relative to a particular ADIZ. Flights exempted in accordance with para 7.1.4 will not be exempted from the special requirements unless so specified.

## 7.3 Non-Compliance

7.3.1 Significant deviations from the requirements for flight in an ADIZ must be reported immediately to ATS and details and reasons for the deviation must be reported at the first point of landing, for transmission to the Regional Air Defence Commander.

## 7.4 Diversion of Aircraft for Defence Operations

7.4.1 The Regional Air Defence Commander may, through ATS, direct the flight of aircraft in the interests of national security. Messages initiating such requirements will be prefaced by 'MILITARY OPERATIONS REQUIRE...'



**ENR 5.3 OTHER ACTIVITIES OF A DANGEROUS NATURE AND OTHER POTENTIAL HAZARDS**

1. Other general activities of a dangerous nature.

<b>Lateral Limits Coordinates</b>	<b>Vertical Limits</b>	<b>Advisory measures</b>	<b>Authority responsible for INFO</b>	<b>Remarks Time of ACT</b>
1	2	3	4	5
<b>BUSHFIRES</b> 5NM from any bushfire	<u>3,000ft AGL</u> SFC	Avoid area due to potential aerial firefighting traffic	NOTAM may be issued by the relevant State Fire Authority	Any time a bushfire is present
<b>WARSHIPS</b> 5NM from any warships	<u>2,000ft AMSL</u> SFC	Avoid area due to potential military aerial traffic	Traffic alerts and warnings may be passed on FREQ 121.5MHz	Any time warships are present

2. Other potential hazards.

<b>Lateral Limits Coordinates</b>	<b>Vertical Limits</b>	<b>Advisory measures</b>	<b>Authority responsible for INFO</b>	<b>Remarks Time of ACT</b>
1	2	3	4	5
<b>VOLCANIC ASH</b> Subject to prevailing winds	<u>FL600</u> SFC	Avoid flying through volcanic ash.  Remain clear of visible volcanic ash and reports of ash clouds.	SIGMET report may be issued by the Bureau of Meteorology	Any time a volcanic ash is present. See AC 91-33

## ENR 5.4 AIR NAVIGATION OBSTACLES - EN ROUTE

### 1. MAN-MADE OBSTACLES GREATER THAN 360 FEET

1.1 In Australia, man-made obstacles greater than 360FT are required to be reported. Where required for navigation purposes, these obstacles are identified on aeronautical maps and charts. Unreported obstacles up to 360FT may exist in navigational tolerance areas. Pilots are, therefore, required to take this into account when calculating LSALT.

### 2. MARKING OF POWER LINES AND OTHER OVERHEAD CABLES

2.1 The standards for marking power lines and other overhead cables with long spans are addressed by Standards Australia in the following documents:

- a. AS 3891.1 - 2008, Air navigation - Cables and their supporting structures - Marking and safety requirements. Part 1: Permanent marking of overhead cables and their supporting structures for other than planned low-level flying; and
- b. AS 3891.2 - 2018, Air navigation - Cables and their supporting structures - Marking and safety requirements Part 2: Low level aviation operations.

### 3. NVIS AND OBSTACLE LIGHTING

3.1 Some LED lighting systems, clearly visible to the naked eye, fall outside the combined visible and near-infrared spectrum of NVIS and therefore will not be visible to operating crew using NVIS.

## ENR 5.5 AERIAL SPORT AND RECREATIONAL ACTIVITIES

### 1. GLIDING OPERATIONS

#### 1.1 General

1.1.1 ADF - For aerial sport and recreational activities relating to gliding operations refer to *CASR Part 103* and the *Part 103 MOS*.

1.1.2 Pilots should take extra care when operating at an aerodrome where gliding operations are in progress. Gliding operations are indicated by the "gliding operations in progress" ground signal displayed next to the primary wind direction indicator. Pilots should also establish whether the gliders are being launched by wire or aerotow, or both.

1.1.3 Where aerotowing is in progress, pilots should remain well clear of gliders under tow. If wire launching is used, pilots should establish the locations of either the winch or tow car and the cable, and remain well clear. Over-flying the runway below 2,000FT AGL is not advised, nor is landing without first ascertaining that the cable is on the ground and not across the landing path. Aerotow and winch launching are possible up to 4,000FT AGL, but launches to 1,500FT or 2,000FT AGL are normal.

1.1.4 In Class G airspace, gliders may be operating no-radio, on Area VHF or on frequencies 122.5, 122.7 or 122.9MHz. Radio-equipped gliders at, or in the vicinity of, non-controlled aerodromes make broadcasts in accordance with the table at *ENR 1.1 para 9.1.14*.

#### 1.2 Operations at Certified Aerodromes

1.2.1 Gliding operations may be conducted from:

- a. a glider runway strip within the runway strip (single runway), using a common circuit direction;
- b. a glider runway strip adjacent to the existing runway strip (dual runways), using a common circuit direction; or
- c. a separate glider runway strip parallel to and spaced away from the existing runway strip (parallel runways), using contra-circuit procedures.

1.2.2 Details of the gliding operation are published in the ERSAs entry for the aerodrome. When procedures are changed for intensive short-term gliding activity, a NOTAM will be issued.

1.2.3 Where dual or parallel runways are established, the glider runway strip will conform to normal movement area standards, but will be marked by conspicuous markers of a colour other than white. Glider runway strips must not be used except by gliders, tug aircraft and other authorised aircraft.

1.2.4 Where a single runway is established and gliders operate within the runway strip, the runway strip markers may be moved outwards to incorporate the glider runway strip. Glider movement and parking areas are established outside of the runway strips. When the glider runway strip is occupied by a tug aircraft or glider, the runway is deemed to be occupied. Aircraft using the runway may, however, commence their take-off run from a position ahead of a stationary glider or tug aircraft.

1.2.5 Except for gliders approaching to land, powered aircraft have priority in the use of runways, taxiways and aprons where a single runway or dual runway operation is established.

1.2.6 At the locations where parallel runways exist and contra-circuit procedures apply, operations on the two parallel runways by aircraft below 5,700KG MTOW may be conducted independently in VMC by day. Aircraft must not operate within the opposing circuit area below 1,500FT AGL. Pilots should ascertain the runways in use as early as possible and conform to that circuit. A crossing runway should only be used when operationally necessary, and traffic using the crossing runway should avoid conflicting with the established circuit.

1.2.7 At aerodromes other than for which contra-circuits are prescribed, gliders are generally required to conform to the established circuit direction. However, unforeseen circumstances may occasionally compel a glider to execute a non-standard pattern, including use of the opposite circuit direction in extreme cases.

1.2.8 A listening watch on the appropriate VHF frequency must be maintained while operating at or in the vicinity of non-controlled aerodromes by the tug pilot. The winch or tow-vehicle driver should also maintain a listening watch during wire launching. The tug pilot or winch/car driver may be able to advise glider traffic information to inbound or taxiing aircraft.

*Note: The appropriate VHF frequency is as described at ENR 1.1 sub-section 9.1.*

1.2.9 Where wire launching is used, launching will cease and the wire will be retracted or moved off the strip when another aircraft joins the circuit or taxis, or a radio call is received indicating this. A white strobe light is displayed by a winch, or a yellow rotating beacon by a tow-car or associated vehicle, whenever the cable is deployed.

## 2. PARACHUTING OPERATIONS

### 2.1 General

2.1.1 ADF - For aerial sport and recreational activities relating to parachuting operations refer to *CASR Part 105* and the *Part 105 MOS*.

### 2.2 Conflicting Traffic

2.2.1 ATC will provide separation between parachutists and non-parachuting aircraft in Class A, C and D airspace, and provide traffic information to pilots of aircraft engaged in parachuting operations on known or observed traffic in Class E and Class G airspace.

### 2.3 Additional Requirements in Controlled Airspace

2.3.1 ATC base separation on the assumption that the parachutist will be dropped within 1NM of the target. If an extension of this area is necessary, the pilot must advise ATC of the direction and distance required.

### 2.4 Additional Requirements for Operations Above 10,000FT AMSL

2.4.1 Pilots should refer to *Division 26.11* of the *Part 91 MOS* for the requirements relating to oxygen usage for high altitude flights.

### 3. BALLOON OPERATIONS

#### 3.1 ADF - The RAAF Balloon Flight

3.1.1 Central Flying School is tasked to operate hot air balloons as one of the Air Force's public relations assets. The balloons are owned and operated by the RAAF under civil licensing and airworthiness regulations in the Civil Aviation Safety Authority's (CASA) "Private" category of balloon operations. This category is regulated by CASA and administered by the Australian Ballooning Federation (ABF). Additionally, Defence provides an overlay of orders and instructions that entail airworthiness management requirements.

3.1.2 As Defence assets, all activities associated with the RAAF Balloon must comply with Defence standards. The RAAF Balloon is to be operated in accordance with *Civil Aviation Regulations 1988 (CAR)*, *Civil Aviation Safety Regulations 1998 (CASR)*, *Civil Aviation Orders (CAO)*, *The Australian Ballooning Federation (ABF) Inc Operations Manual and Defence Instructions*. Should regulatory conflicts occur, the RAAF Balloon will be operated to the more restrictive regulation, instruction or order.

3.1.3 Pilots are reminded of the requirement to not operate an aircraft in a manner which creates a hazard to a person or property, (*CASR 91.055*). Outside of a populous area or public gathering, balloons do not need to maintain a minimum height AGL. However, this does not absolve pilots from any responsibility not to cause a hazard to landholders, stock, persons or property. Pilots planning to conduct balloon operations in an unfamiliar area are recommended to contact local area balloon operators for landowner information, and to check for compliance with State, Territory or Federal laws and the rights of landowners and occupiers.

#### 3.2 General

3.2.1 For rules relating to ballooning operations refer to *CASR Part 131* and the *Part 131 MOS*.

3.2.2 Pilots of balloons engaged in private operations are required to carry radio and use it in accordance with the procedures described in ENR 1.1 Section 6. whilst they are operating:

- a. within the vicinity of a non-controlled aerodrome where radio carriage and use is required;
- b. at or above 5,000FT above mean sea level;
- c. within 10NM of an aerodrome with a published instrument approach procedure; or
- d. at night.

3.2.3 The holder of a private pilot certificate issued by the Australian Ballooning Federation Inc may have that certificate endorsed to permit radio communication on VHF frequencies only, without being the holder of a flight radiotelephone operator licence

#### 3.3 Operations in the Vicinity of Aerodromes

3.3.1 Within 3NM of an aerodrome, the aircraft captain of a balloon is required to give way to other traffic operating in the traffic pattern of the aerodrome which is applicable to the runway in use at the time.

3.3.2 The aircraft captain of a balloon who intends to overfly an aerodrome within 3NM should do so at a height greater than 1,500FT above the aerodrome. In the case of a private balloon flight which is not specifically authorised by CASA, overflight must be conducted more than 2,000FT above the aerodrome.

3.3.3 The pilot of a balloon which is taking off within 3NM of an aerodrome must give way to aircraft which are landing or on final approach to land, by delaying their take-off or, if airborne, by climbing or descending to remain clear of the other aircraft's flight path.

#### 3.4 Meteorological Conditions

3.4.1 ENR 1.2 Section 2. prescribes VMC for balloons. Operations in other than prescribed VMC are not permitted.

#### 3.5 Night Balloon Operations

3.5.1 Aerial work and charter operations by pilots who hold a NVFR (balloon) rating, and private operations with specific permission from CASA, may be conducted at night. In the case of aerial work and charter operations, these are restricted to the period of one (1) hour prior to first light.

### 3.6 Operations in Controlled Airspace

3.6.1 Prior to a proposed flight in controlled airspace, a balloon operator or aircraft captain must liaise with ATS as follows:

- a. contact ATC by telephone or radio prior to inflating the balloon to advise the planned launch site and likely direction or area of flight, and ascertain the availability of an ATC clearance; and
- b. call to obtain a clearance before becoming airborne.

3.6.2 The balloon pilot must maintain a continuous listening watch on the appropriate frequency during flight within controlled airspace, and report flight progress as required by ATC. The pilot must report changes in the direction of drift, which will cause the balloon to diverge from its nominated track or area of operations, as soon as possible, and, in any case, before the track error exceeds one (1) nautical mile.

3.6.3 For operations in an area of controlled airspace within RADAR coverage, a serviceable SSR transponder must be carried unless ATC has advised that a transponder is not required for that flight.

3.6.4 In the event of a radio failure or other emergency, the relevant procedures as listed elsewhere in AIP must be followed. Particular attention should be given to notifying the termination of a flight where radio contact is not able to confirm this.

### ENR 5.6 BIRD MIGRATION AND AREAS WITH SENSITIVE FAUNA

1. In Australia, bird migration areas are not identified. However, at locations where birds may pose a particular hazard, a note describing the hazard at a particular location will be contained in ERSA.

2. Some areas which may have special significance because of sensitive fauna or other ecological considerations are identified as "Fly Neighbourly Advice" area. Details on these areas are contained in ERSA under the heading SPECIAL PROCEDURES (NOT ASSOCIATED WITH AN AERODROME).



## AD 1 AERODROMES/HELIPORTS - INTRODUCTION

### AD 1.1 AERODROMES/HELIPORTS AVAILABILITY AND CONDITIONS OF USE

#### 1. GENERAL CONDITIONS

1.1 **ADF** - Information concerning aerodromes within Australia is published by the CASA in the Manual of Standards Part 139 - Aerodromes and associated guidance material available on CASA website: [www.casa.gov.au/rules/regulatory-framework/casr/part-139-casr-aerodromes](http://www.casa.gov.au/rules/regulatory-framework/casr/part-139-casr-aerodromes), and by AIS-AF in the ADF AIP.

1.2 The aerodrome directory is published as *En Route Supplement Australia (ERSA) Facilities (FAC)* which lists certified aerodromes along with their availability and conditions of use.

1.3 Details of uncertified aerodromes and helicopter landing sites are also included in *ERSA FAC* when requested by the aerodrome operator. It is the responsibility of pilots and air operators intending to conduct operations at uncertified aerodromes or helicopter landing sites to obtain current information on that location from the aerodrome owner/operator prior to flight planning and to assess the suitability of the aerodrome/heliport for the intended operation.

#### 2. ADF - MILITARY AIR BASES

##### 2.1 Civil use of military Air Bases

2.1.1 Civil aircraft may only operate at a military aerodrome with prior permission issued by the relevant Military Authority. Additional conditions or instructions may apply in the relevant ERSA entry for the aerodrome, or in AIP SUP and NOTAM for temporary military activities. Darwin and Townsville are designated as joint-user aerodromes and civil aircraft do not require prior permission from the relevant Military Authority.

##### 2.2 ADF - Military Aerodrome Aircraft Arrestor Systems (AAS)

2.2.1 **Aircraft Arrestor Systems.** The role of the AAS is to provide a capability to pilots of some aircraft types to rapidly decelerate and stop their aircraft on the runway or stopway. AAS are operated in the following standard configurations:

a. **M34B AAS (barrier net system).**

- (1) All barriers lowered for normal operations.
- (2) Departure end barrier is raised when requested by the pilot using the phrase 'BARRIER, BARRIER, BARRIER'.

b. **BAK 12 (mobile AAS).** Departure end cable rigged for use during arrest capable aircraft operations. Approach end cable is only rigged when advised a cable engagement is required (requires 15 minutes prior notice).

- (1) Departure end cable is rigged for use during arrest capable aircraft operations.
- (2) Approach end cable is only rigged when advised a cable engagement is required (requires 15 minutes prior notice).

c. **BAK 14 (fixed AAS).**

- (1) During dry conditions, the departure end cable is raised for arrestable aircraft departures and all cables are lowered for landings.
- (2) During other than dry conditions, tailwind component or emergency landings, only the departure end cable is raised for arrestable aircraft movements.
- (3) All cables are raised when requested by the pilot using the phrase 'CABLE, CABLE, CABLE'.

d. **AAS Location.** The location of AAS for each applicable aerodrome and runway are described in ERSA.

2.2.2 **Pilot Procedures.** Pilots are responsible for AAS aircraft type restrictions concerning trampling or engaging the barrier or cable. Pilots must advise ATC if the status of the AAS is operationally unacceptable.

2.2.3 **ATC Procedures.** ATC retains overall control of an AAS until specifically handed over to another ground party. When the AAS is not in the normal operating position for the relevant aircraft, ATC must:

- advise the pilot of the status of the AAS position (e.g. approach/departure end cable/barrier failed in the up/down position),
- offer the pilot with landing options available (e.g. option to land long with landing distance available)
- should not with hold a take-off or landing clearance when the pilot has advised the AAS is status is acceptable.

2.2.4 **Phraseology.** Pilots requiring an AAS engagement in an emergency will alert ATC with the phrase 'CABLE, CABLE, CABLE' or 'BARRIER, BARRIER, BARRIER' as applicable. ATC will respond with 'DEPARTURE END CABLE/BARRIER UP'.

2.2.5 **AAS Trampling Criteria.** The following aircraft landing trampling criteria is provided as a guide for ATC reference. For departure application, landing trampling criteria may be applied. ATC should seek clarification from the Aircraft Captain when trampling of the cable may be required by non-arrestable aircraft.

**Table 1.1: Landing AAS trampling data**

Aircraft	BAK 12 mobile AAS <sup>1</sup>		BAK 14 fixed AAS <sup>1</sup>		Aircraft limit (*)
	Approach end	Departure end	Approach end	Departure end	
* indicates a limitation exists					
<b>ADF aircraft</b>					
F-35A	Yes	Yes	Yes	Yes	-
F/A-18F	Yes	Yes	Yes	Yes	25KT normal ops
EA-18G	Yes	Yes	Yes	Yes	25KT normal ops
Hawk Mk 127 LIF	No	*	No	*	Walking pace
PC-21 <sup>2</sup>	No	No	No	No	Not approved
B300 KA350	No	No	No	No	Not approved
KC-30A	*	*	*	*	Visual inspection
C-17A	No	*	No	*	Taxi speed
C-130J	No	*	No	*	Taxi speed
C-27J	No	No	No	No	Not approved
F7X	No	No	No	No	Not approved
B737-700IGW-BBJ	*	*	*	*	Nose gear 25KT
E-7A	No	*	No	*	40KT
A47 P-8A	Yes	Yes	Yes	Yes	-
<b>Other aircraft</b>					
Lear Jet	No	No	No	No	Not approved
Qantas all	*	*	*	*	Taxi speed only
Note:					
1. 'No' indicates trampling the AAS is not approved and (*) indicates there are aircraft limits to be considered.					
2. Includes RSAF PC-21					



2.3 Civil aircraft may only operate at a military aerodrome with prior permission issued by the relevant Military Authority. Additional conditions or instructions may apply in the relevant ERSA entry for the aerodrome, or in AIP SUP and NOTAM for temporary military activities. Darwin and Townsville are designated as joint-user aerodromes and civil aircraft do not require prior permission from the relevant Military Authority.

### **3. LOW VISIBILITY OPERATIONS**

#### **3.1 Approval Required**

3.1.1 Aircraft operators may conduct a low visibility operation (LVO) only if specifically approved by OAA. Approvals for LVO are granted in the form of an exemption to the standard IFR take-off and approach minima.

3.1.2 AC 91-11 contains specific information and guidance on gaining approval to conduct LVO operations.

#### **3.2 Low Visibility Procedures**

3.2.1 Low Visibility Procedures (LVPs) are applied at controlled aerodromes for protecting aircraft operations during conditions of reduced visibility or low cloud. LVPs are initiated when the visibility on an aerodrome becomes insufficient for ATC to control aerodrome traffic by visual surveillance. Low visibility protection measures are progressively implemented as the weather deteriorates.

3.2.2 Pilots will be notified that low visibility procedures are in force by ATIS broadcast or directed transmissions.

### 3.3 Protection of ILS Critical and Sensitive Areas

3.3.1 ATC provides differing levels of protection for ILS critical or sensitive areas depending on the type of approach or departure, the position of an approaching aircraft, and the prevailing weather conditions at the time the approach is commenced. The different scenarios and protection levels are described in the following table:

Type of Operation	Weather Conditions	ILS Critical or Sensitive Area Protection
Any ILS Approach	Cloud ceiling > 600FT or Visibility > 2,000M	ILS Critical and Sensitive areas <b>are not protected.</b>
Any ILS Approach	Cloud ceiling ≤ 600FT, but ≥ CAT I minima; or Visibility ≤ 2,000M, but ≥ CAT I minima.	ILS Critical Area is protected except: - When a preceding aircraft enters the critical Area while landing or vacating; or - For the time prior to the approaching aircraft passing the ILS OM, or if no OM, is within 4NM of threshold.  ILS Sensitive area is not protected.
SA CAT I, SA CAT II, CAT II and CAT III	Cloud ceiling or visibility < CAT I minima.	ILS Critical Area is protected when the arriving aircraft has passed the OM, or if no OM, is within 4NM of touchdown.  ILS Sensitive Area is protected when the aircraft is within 2NM of touchdown.
Localiser guided take-off	Visibility < 550M	Localiser Critical and Sensitive Area protected until the aircraft has completed its take-off.

3.3.2 **Caution-** Pilots may experience the ILS beam bends and other interference in the circumstances where ATC is not protecting the ILS critical area or ILS sensitive area.

3.3.3 In weather conditions where the ceiling and/or visibility are above CAT I minima, pilots should inform ATC about any intention to conduct:

- a. an approach with minima less than standard CAT I; or
- b. an autoland procedure.

This information must not be taken as a request for or expectation of the protection of the ILS but to enable ATC to inform the flight crew of any known or anticipated disturbance.

3.3.4 ATC will inform pilots that the relevant protection measures are in place by reporting "LVP in force" on the ATIS or by direct advice.

3.3.5 At start-up, pilots should inform ATC about any intention to conduct a guided take-off that requires guidance provided by an ILS localiser.

*Note: Localiser guided take-offs are generally supported on runways which have published CAT III approaches.*

**4. AERODROME MARKERS AND MARKINGS**

**4.1 Boundary Markers**

4.1.1 Gable and/or cone markers are used to indicate:

- a. the graded surface of a runway strip;
- b. the edges of an apron and/or taxiway where such are not clearly defined; and
- c. the limits of the movement area.

They take the form shown in [Figure 1](#).

Figure 1 - Boundary Markers

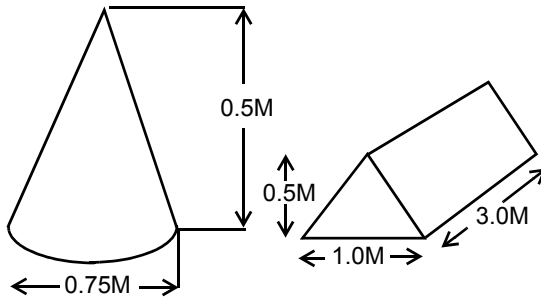

4.1.2 When used to mark the graded portion of runway strips, cone markers are spaced at not more than 90M intervals along the limits of the runway strip, and gable or flush markers are spaced at not more than 180M intervals. Two gable markers are used at corners.

4.1.3 When used to mark the definition of aprons or taxiways the markers are spaced at not more than 15M intervals.

4.1.4 Boundary markers are white coloured, except those associated with the limits of ill-defined aprons and taxiways, which are yellow. Where a threshold is permanently displaced, dun-coloured cone markers are used to denote the area prior to the displaced threshold.

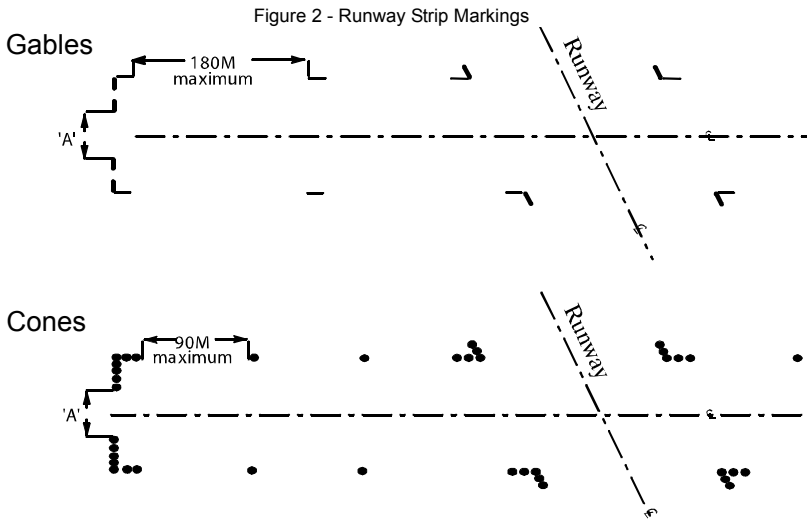

#### 4.2 Runway Markers

4.2.1 Runway Markers are provided on runway edges, at minimum intervals of 60M, along both sides of the runway where there is a lack of contrast between the runway and the adjacent runway strip. Where the runway strip is maintained to the same standard as the runway across its entire width, only runway end markers are used. Runway markers may be either:

- a. runway cone markers,
- b. inverted white plastic buckets,
- c. white PVC road safety cones,
- d. flush markers.

#### 4.3 Unserviceable Areas

4.3.1 An aircraft must only operate on an aerodrome that is suitable and where it is safe to do so under the circumstances (*CASR 91.410*). An area of an aerodrome that is declared "unserviceable" would not be considered as suitable or safe to operate on.

4.3.2 **Partial Unserviceability.** Except for instances of total unserviceability or restricted operations, unserviceable areas on the movement area are indicated by the display of unserviceability cross markers.

- a. An unserviceability cross marker, normally coloured white, consists of a cross, with arms at least 6M long, 0.9M wide and not more than 0.15M high.
- b. The limits of unserviceable areas are delineated by white cone markers painted with a 0.25M wide horizontal red band.

4.3.3 **Total Unserviceability.** When an aerodrome that does not have 24HR ATC coverage is completely unserviceable for all operations, an unserviceability cross marker is displayed in the signal circle.

### 4.4 Restricted Operations

4.4.1 When operations at an aerodrome which does not have 24HR ATC coverage are confined to hard surface runways, taxiways and aprons, a dumb-bell marker is displayed in the signal circle. A dumb-bell marker is white and takes the form shown in [Figure 3](#).

Figure 3 - Restricted Operations "Dumb-bell" Marker

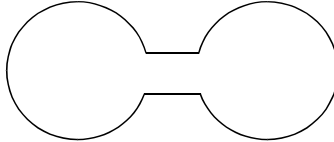

### 4.5 Runway Markings

Runway markings are normally white, but may be edged in black to improve definition.

4.5.1 **Runway Threshold Markings.** Wherever a threshold marking is displayed, it marks the commencement of the permanent or declared landing distance.

4.5.2 **Permanent Threshold.** Threshold markings consisting of parallel longitudinal white lines resembling "piano keys" are used at the ends of sealed or concrete runways of 30M or greater width. For runways less than 30M wide, the markings may be used.

4.5.3 **Permanently Displaced Threshold.** "Piano key" markings displaced from the runway end indicate that the normal approach is obstructed by a permanent obstacle, or that a permanent hazardous surface condition exists near the end of the runway.

Figure 4 - Permanent Threshold Marking

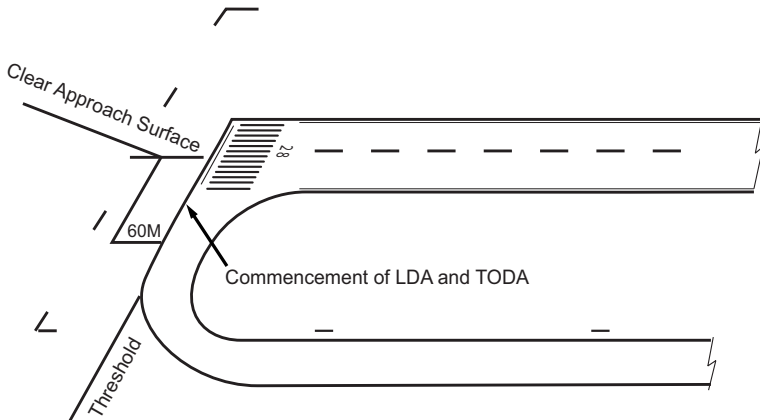
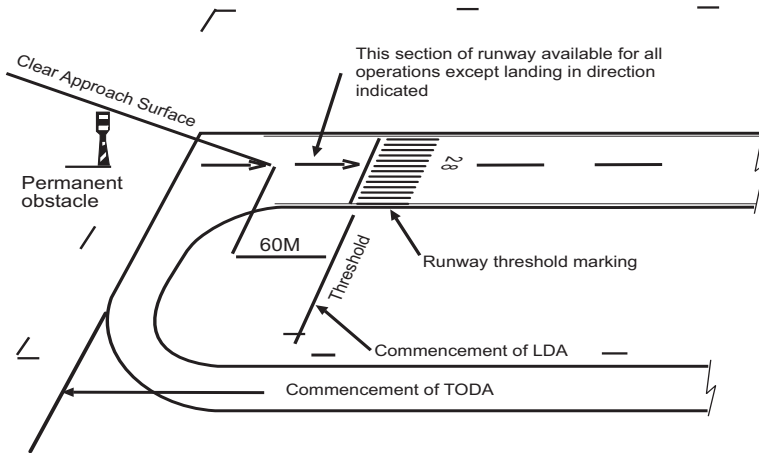

Figure 5 - Permanently Displaced Threshold Marking



**4.5.4 Temporarily Displaced Threshold Markers and Markings.** When a threshold is temporarily displaced it will be shown either by lights or by the following:

- a series of inverted "V" markings (white) painted across the runway (Figure 6); or
- one, or two, V-Bar markers (white) situated on both sides of the runway (Figure 8); or
- at military controlled aerodromes, for periods of short duration, when military operational requirements dictate, four white cones situated on both sides of the runway.

*Note: Strobe lights may be used instead of V-Bar markers. Permanent "piano key" and runway designation number markings will be obliterated where the duration of the temporary displacement exceeds 30 days; however, for shorter periods all existing runway markings remain.*

**4.5.5** Other markers or markings which may be associated with temporarily displaced thresholds are:

- unservicable cone markers (white and red) which, when placed across a runway between the permanent and temporary threshold markings, denote the start of the take-off run available;
- road safety cones or "witches hats" (orange) which, when placed across the full width of the runway strip, denote the manoeuvring limits for plant and equipment involved in works;
- unservicable cross markers (white), which indicate any part of the movement area not available for operations;
- centreline arrows (white) to draw the pilot's attention to the displaced threshold. Unless otherwise indicated by unservicable markings, the length of a runway containing centreline arrows is available for take-off in the direction of the arrows (see diagram) and for both take-off and landing in the other direction.

*Note: Relevant NOTAM advice is provided on the length of the displacement, anticipated duration and type of temporary threshold provided.*

Figure 6 - Markings for a temporarily displaced threshold due to obstacle infringement of the approach path for a period in excess of 30 days

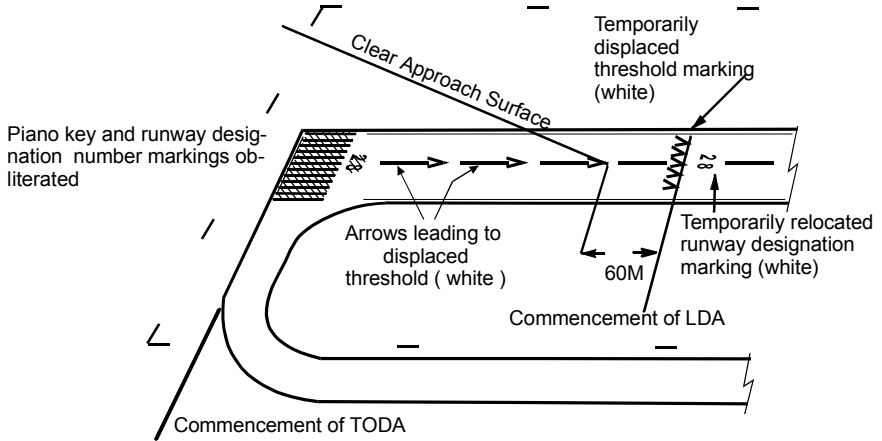

Figure 7 - Markings for a temporarily displaced threshold due to works on a runway for periods in excess of 30 days

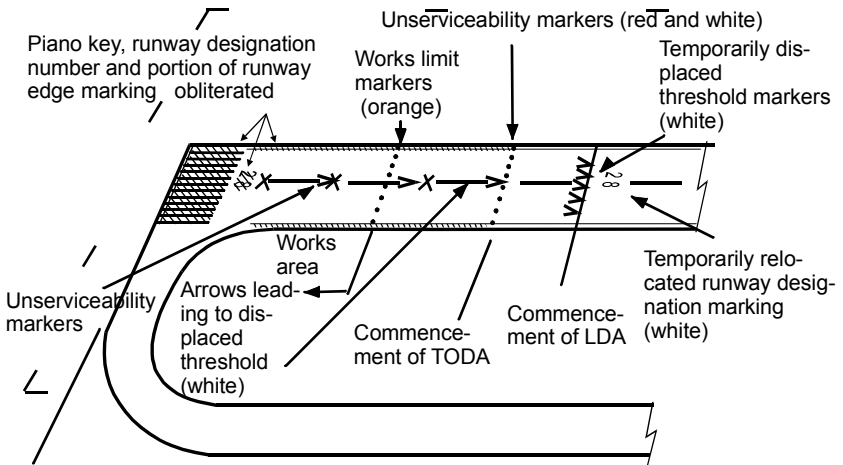

Figure 8 - Markings for a temporarily displaced threshold due to obstacle infringement of approach surface for a period of 30 days or less

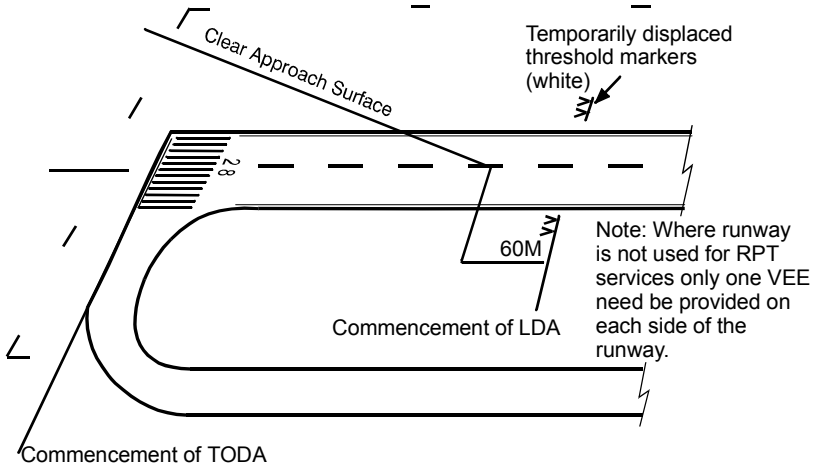
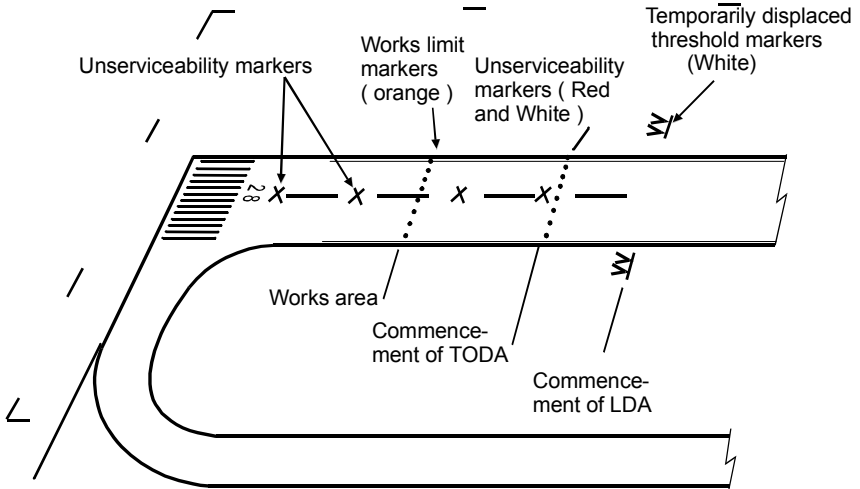

Figure 9 - Markings for a temporarily displaced threshold due to works on the runway for a period of 30 days or less



4.5.6 **Runway Side Stripe and End Marking.** Solid white lines delineate the edges of the full strength pavement on sealed or concrete runways.



4.5.7 **Sealed Area Beyond the Runway.** A sealed area beyond the runway end that is not suitable for normal use by aeroplanes is marked for its entire length by yellow Vee Bars. A sealed stopway or blast area that is not suitable for taxiing is defined by the white line delineating the edge of the full strength pavement. Refer to Figure 10.

Figure 10 - Markings of Areas Beyond Runway Ends

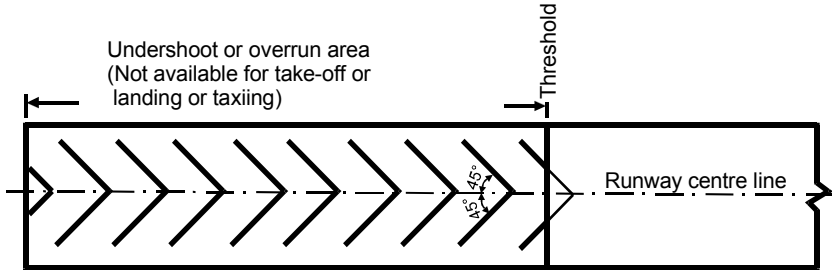

4.5.8 **Runway Centreline Markings.** These markings indicate the centre line on all sealed or concrete runways whose width is 18M or greater and consist of a solid 30M long white line followed by a 30M gap repeated for the full length of the runway. Refer to Figure 13.

4.5.9 **Aiming Point and Touchdown Zone Markings.** These markings may be used on both ends of sealed or concrete runways to provide visual guidance whilst landing. Two forms of touchdown zone and aiming point markings may be used:

- a. **Aiming point and simple touchdown zone markings.** These markings are used for most runways and consist of 3 pairs of stripes as shown in Figure 11.
- b. **Aiming point and ICAO'A' - basic pattern touchdown zone markings.** These markings are progressively being implemented on precision approach runways and may also be used for other runways. These markings consist of varying numbers of stripes (depending on runway length as shown in Figure 12.)

*Note: Aiming point markings were formerly known as fixed distance markings.*

Figure 11 - Aiming Point and Simple Touchdown Zone Markings

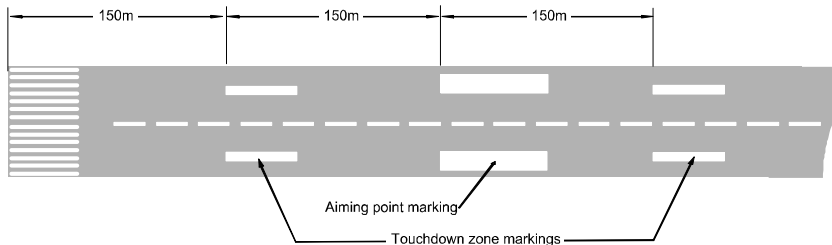
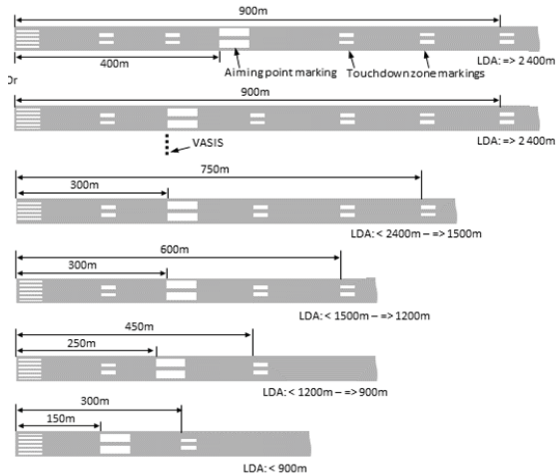

Figure 12 - Aiming Point and ICAO 'A' - Basic Pattern Touchdown Zone Markings



4.5.10 **Runway Numbers.** Two digit numbers are used on sealed or concrete runways to identify the runway and are derived from the magnetic heading of the runway. Where two or more runways have a number which may be confusing, the runway number may not reflect the magnetic heading.

4.5.11 **LAHSO Hold-Short Position Markings.** Taxi-holding position markings (see paragraph 4.11.4) are used to mark runway hold short positions for LAHSO.

4.5.12 **Hold Short Position Markings - Runways used for Taxiing.** Taxi-holding position markings (see paragraph 4.11.4) are used for runway/runway intersections where one runway is used as part of a standard taxi route.

Figure 13 - Combined Runway Markings

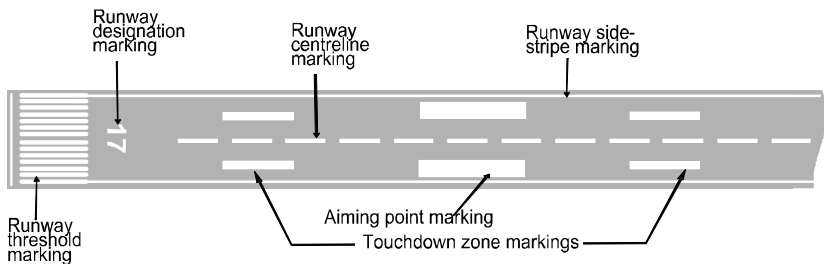

**4.6 Runway Strip Markings**

4.6.1 Runway strip markings consisting of white cone, gable or flush markings indicate the limits of the graded portion of a runway strip.

**4.7 Stopway Markings**

4.7.1 Stopways are not marked and end at least 60M before the strip end.

#### 4.8 Distance To Run Markers (DTRM)

4.8.1 With the exception of multi-lane runways, sealed runways are to be equipped with distance to run marker boards.

4.8.2 **Siting Criteria.** The boards are to be sited (see [Figure 14](#)) in accordance with the following criteria:

- a. They are to be sited on both sides of each sealed runway.
- b. The markers are to indicate the runway distance remaining in thousands of feet (the last three digits being omitted).
- c. The markers are to be numbered from the upwind end of the runway, increasing towards the beginning of the runway, the figure '1' being 1000 feet from the upwind end.
- d. The boards are to be mounted vertically at right angles to the longitudinal axis of the runway and 18M from the runway edge.
- e. Markers which would normally be at a runway or taxiway intersection may be omitted. Such markers may, however, be displaced 100FT from their true position if this makes it possible to avoid omitting them altogether.
- f. The distance of the markers from the edge of a taxiway shall not be less than 15M.
- g. Where the length of the runway is other than a multiple of 1000FT, half the odd length shall be used at each end of the runway for computing the position of the markers.

Example:

Rwy length = 9800 FT

Odd length = 800 FT

DTRM Board '1' = 1400 FT from each up wind end

Figure 14 - Distance To Run Marker - Site Plan.

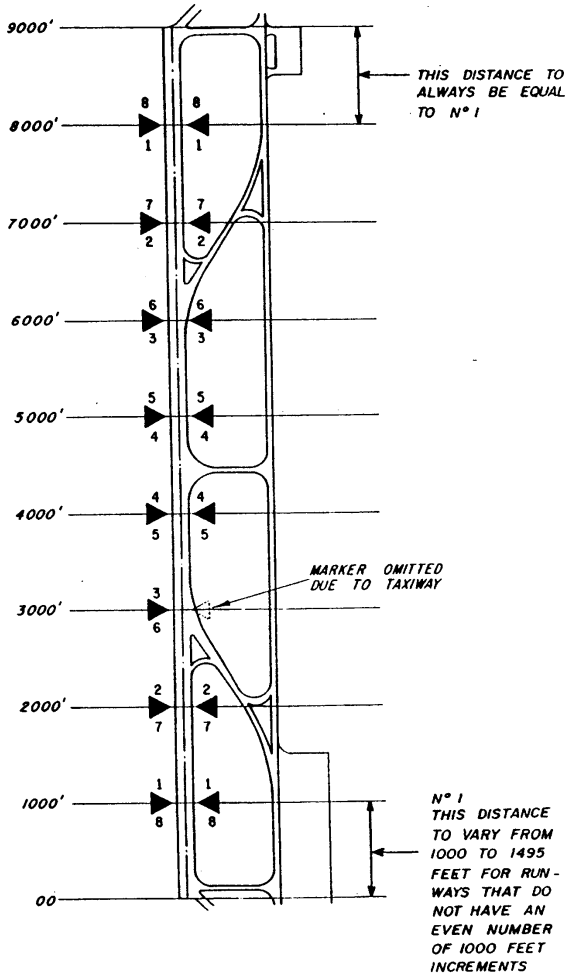

4.8.3 **Marker Board Design.** Marker boards are to be constructed and marked in accordance with the following criteria:

- The design shall be such as to ensure readability from a minimum distance of 150M in a meteorological visibility of 900M.
- The boards are to measure 1.8M in height and 1.2M in width.
- The height of the figures is to be 1.5M. The breadth of each figure is to be approximately 0.9M and the stroke of each figure is to be approximately 13cm.
- The colour of the numbers is to be white on a black background.
- The sign is to be of frangible construction to minimise aircraft damage should impact occur.
- The sign is to be illuminated to ensure readability at night and in adverse weather conditions.

4.9 Hookcable Markers

4.9.1 On runways where hookcable aircraft arresters systems are installed, the position of the hookcable is to be indicated by illuminated hookcable marker boards.

4.9.2 **Siting Criteria.** The markers are to be sited in accordance with the following criteria and as illustrated in Figure 15:

- a. placed on both sides of the runway in line with the hookcable pendant and normally equidistant from the runway centre line, and
- b. positioned not less than 15 metres from the edge of the full strength pavement and normally not more than 23 metres there from.

Figure 15 - Hookcable marker board - Site plan.

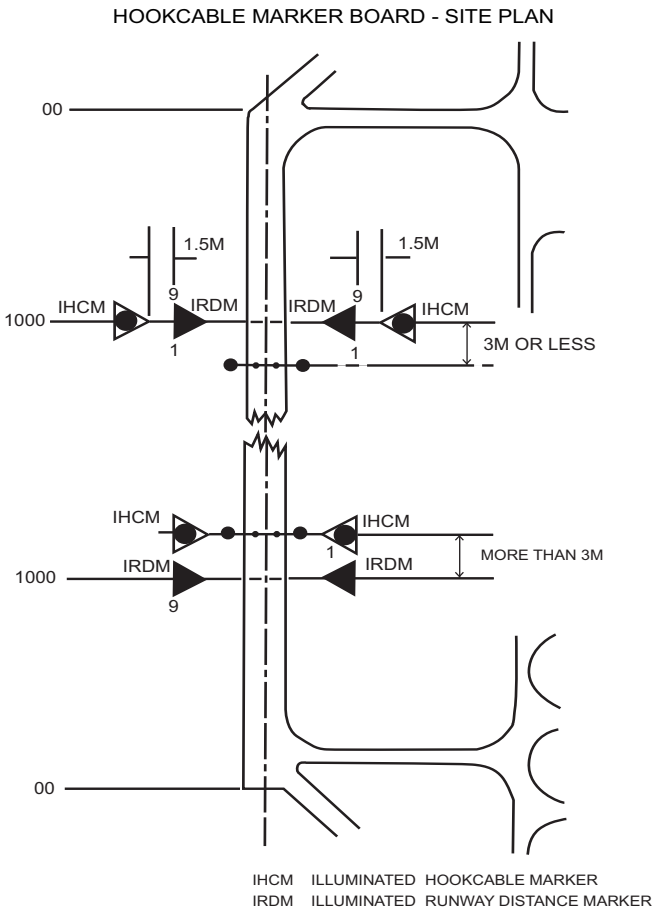

4.9.3 **Marker Board Design.** The markers are to be constructed and marked in accordance with the following criteria:

- design shall be such as to ensure identification from a minimum distance of 450 metres in a meteorological visibility of 900 metres,
- the marker symbol is to be displayed for both runway directions,
- the marker display is to comprise a yellow or orange disc one metre in diameter on a black background,
- the sign is to be of frangible construction, and
- the sign is to be illuminated to ensure readability at night and in adverse weather.

4.10 **Arrester Systems Warning Marking.** On runways equipped with hookable aircraft arrester systems, arrester system warning markings are to be displayed on the runway at the point where the hookcable crosses the runway. The markings consist of a line of solid yellow circles 3M in diameter located as shown at [Figure 16](#).

Figure 16 - Arrester Gear Markings

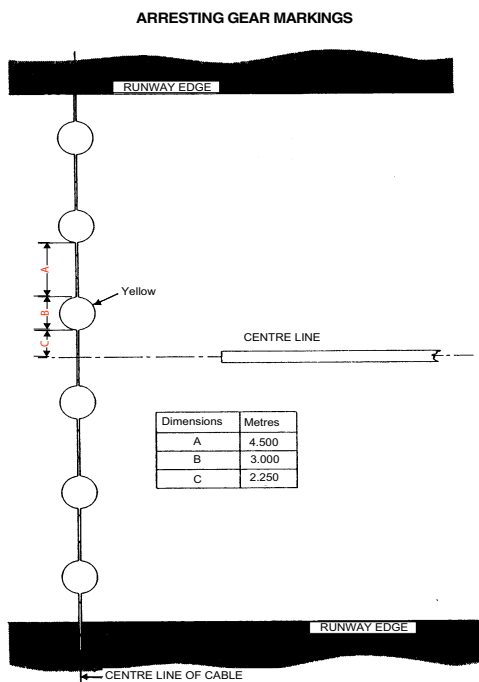

#### 4.11 Taxi Guide-line Markings

These markings provide position guidance for pilots, and are normally painted yellow.

4.11.1 **Taxiway-edge Markers and Markings.** On unpaved taxiways, where the edges are not visually distinct, yellow taxiway-edge cones are provided. For gravel taxiways, yellow taxiway-edge marking strips may be used.

4.11.2 **Taxiway Pavement–Strength Limit Markings.** These markings are painted in at the entrance to an asphalt, sealed or concrete taxiway which has low strength pavement.

4.11.3 **Old Taxi–holding Position Markings.** The type of marking illustrated in Figure 17 is currently used on taxiways, holding bays and aprons to indicate holding or parking positions. Except for aprons, where the aircraft is parked with the main wheels on the marking, aircraft must be held with the nose short of the marking. This marking is yellow.

Figure 17 - Old Holding Position Marking (Taxiway/Runway Intersection)

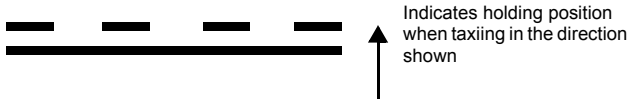

4.11.4 **New Taxi-holding Position Markings.** The type of markings illustrated in Figure 18(a) and (b) will be progressively introduced at Australian aerodromes. Figure 18(a) will replace the existing marking shown in Figure 17. This marking will be used when there is only one holding position. Figure 18(b) is an additional holding position marking which may be used to protect a runway available for Cat I, II or III precision approach operations. Where provided, Figure 18(b) will be further from the runway than Figure 18(a), and will only be applicable when advised by ATC or the ATIS. These markings are yellow.

Figure 18(a) - New Holding Position Marking (Taxiway/Runway Intersection, and LAHSO Hold–Short Position)



Figure 18(b) - New Additional Holding Position Marking Associated with Cat I, II or III Precision Approach Runways



4.11.5 Where a holding position protects a taxiway crossing, only a broken yellow line is provided.

Figure 19 - Holding Position Marking (Taxiway/Taxiway Intersection)



#### 4.12 Holding Bay Markings

4.12.1 Holding bay markings consist of taxiway guide-line and holding position markings.

Figure 20 - Holding Bay Markings

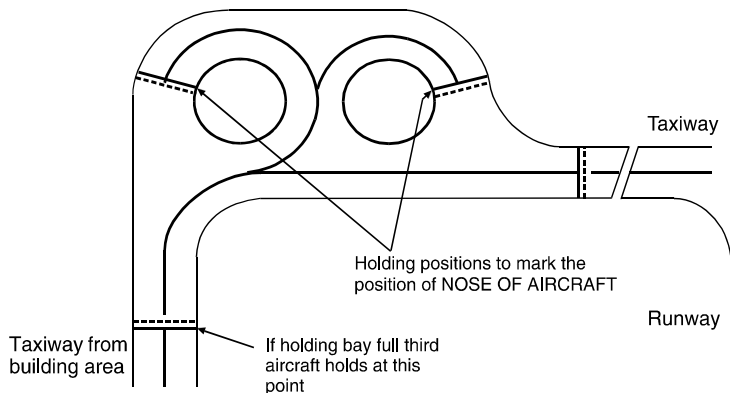

4.13 **Apron Markings.** On aprons accommodating aircraft 5,700KG and above, taxi guide-lines and aircraft parking position markings are provided. Other aprons may be unmarked.

4.13.1 **Apron Edge Markings.** Where aprons are provided with aircraft parking position markings, apron edges may not be marked. On other aprons where low strength shoulders are provided adjacent to apron pavements and the visual differentiation between these surfaces is inadequate, a further marking is provided in critical areas. This marking consists of two 0.15M wide continuous yellow lines 0.15M apart along the edge of the full strength apron pavement. Where pavement is visually uniform but varies in strength, the boundary of the change in strength is delineated by a broken yellow line with informative wording such as "MAX 2300 KG".

4.13.2 **Aircraft Parking Position Markings.** When apron parking position markings are provided, pilots must access the parking positions via the taxi route identified by continuous yellow guide lines.

4.13.3 **Primary Position Taxi Guide Lines.** Primary aircraft parking positions are identified by a continuous yellow taxi guide line.

4.13.4 **Primary Position Markings.** Primary parking position markings comprise two straight yellow lines. One line, the alignment line, shows the required orientation of the parked aircraft. The second line, the stop line, shows the point at which the aircraft is to be stopped.

4.13.5 **Marshaller Stop Line.** Where the pilot is guided by a marshaller, a marshaller stop line is located where the aircraft nosewheel is to stop. It is at right angles to the alignment line, painted yellow, and located on the right hand side of the alignment line as seen by the marshaller looking at the aircraft. The aircraft type designation is painted below the stop line. The lettering, being for the marshaller, is small and upside down when viewed by the pilot.

4.13.6 **Pilot Stop Line.** Where a pilot is not guided by a marshaller a yellow pilot stop line is located so that, when the aircraft is stopped, the line is immediately to the left of the pilot. The aircraft type is written in yellow below the bar.



4.13.7 **Alignment Line.** The yellow alignment line extends from the location of the nose wheel in the parked position backwards under the body of the aircraft. It also extends forward in the alignment of the parked aircraft. A short stripe is located along the alignment bar.

Figure 21 - Primary Aircraft Parking Position Markings

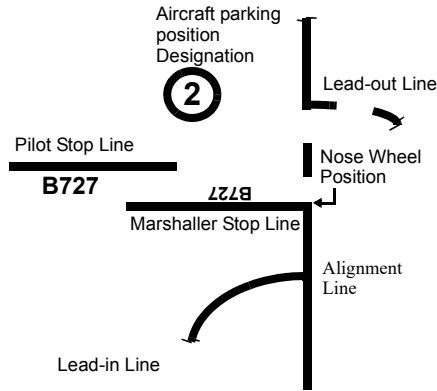

4.13.8 **Secondary Position Guide Lines.** Secondary aircraft parking positions are identified by a line of yellow dots.

4.13.9 **Secondary Position Marking.** These yellow lines may be painted white to avoid confusion where the secondary position overlaps the primary position.

4.13.10 **Keyhole Marking.** Where the secondary position can accommodate aircraft with a wing span of 15M or greater, it will be identified with a keyhole marking, consisting of an alignment line terminating in a ring in which the nose wheel is to be parked.

Figure 22 - Keyhole Marking



4.13.11 **Triangle Marking.** Where a secondary position can not accommodate aircraft with a wingspan of 15M or greater, it will be identified with a triangle marking consisting of an alignment line terminating in a triangle in which the nose wheel is to be parked or in the case of tail wheel aircraft, above which the nose of the aircraft is to be positioned. Triangle markings are also used to mark run-up positions at secondary aerodromes.

Figure 23 - Triangle Marking

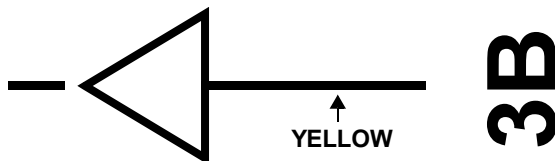

4.13.12 **Lead-out Line.** The parking position lead-out line comprises a broken yellow line commencing at the forward end of the stripe along the alignment line.

4.13.13 **Taxi Guide-line Designation Marking.** Where an apron has more than one parking position, each individual parking position lead-in line is provided with appropriate designation markings where it diverges from the common taxi-guide-line. There are three types of designations: viz, parking position number, aircraft type and aircraft weight.

4.13.14 **Position Designation.** The parking position designation indicates the aircraft parking position to which the taxi guide-line, or lead-in line leads. Where a lead-in line leads to several positions, the designation indicates the first and last numbers of the parking positions served by each line. The designations comprise 2M long yellow characters.

4.13.15 **Type Limit Designations.** Aircraft type limit designation characters are painted yellow and 2M long. Where an apron contains parking position(s) which can only accommodate aircraft smaller than the largest aircraft using the apron, appropriate aircraft type limitations are provided at the lead-in line for each restricted position. Where a parking position is restricted to use by a particular aircraft type, a designation marking such as "B200 ONLY" or "NO C130J" is used. If the parking position is restricted to helicopters then "H ONLY" is provided on the guide-line.

4.13.16 **Weight Limit Designation.** Aircraft weight limit designations are provided to identify the maximum weight limitation at a parking position. Where the apron contains parking position(s) which can only accommodate aircraft of a lighter weight than the heaviest weight allowed elsewhere on the apron then appropriate yellow weight limitations are painted on the relevant lead-in lines.

4.13.17 **Parking Limit Line.** These lines are provided to assist in ensuring that no part of a parked aircraft infringes taxiways or vehicle access roads. The markings consist of two parallel lines 0.1M wide, separated by a red line 0.1M wide. Suitable yellow labels are painted along the line at not more than 50M intervals. The continuity of the line may be broken where normal access is required and aircraft may taxi across the line where necessary.

4.13.18 **Other Apron Markings.** Other apron markings which may be seen at major airports are:

- a. tug push-back lines - broken white;
- b. tow disconnect markers - white;
- c. lease lines - green (not used when coincident with parking limit lines);
- d. equipment limit lines - red, edged in black and suitably labelled;
- e. apron road markings - red, edged in black. These markings are used to define roadways which may be used by uncontrolled vehicles transiting aprons; and
- f. passenger path markings - white on black.

#### 4.14 Obstacle Marking

4.14.1 Inconspicuous obstacles penetrating the obstacle limitation surface of an aerodrome, or which are present on the movement area, are obstacle-marked unless they are shielded by a conspicuous or marked obstacle. Obstacle painting is either in chequered patterns or alternate bands of orange and white or red and white except where such colours would merge with the background. High intensity lighting may be used for tall structures.

4.14.2 In areas away from aerodromes, constructed obstacles between 90M and 150M in height are normally only marked if considered a significant hazard to aircraft. Constructed obstacles above 150M in height are normally marked, unless considered not to be a hazard.

4.15 Aerodrome Information Signs

4.15.1 Aerodrome information signs have black lettering on a yellow background or yellow lettering on a black background. They provide location and direction information at an aerodrome with a complex taxiway layout. The following information signs may be seen:

- a. **Taxiway Location Sign.** A location sign indicates the designation of a taxiway. This sign is often installed in conjunction with a taxi-holding position sign or a direction sign.



Yellow on Black

- b. **Destination Sign.** A destination sign provides directional advice to pilots to proceed to various facilities on the aerodrome. Where abbreviations are used, they have the following meaning:
  - (1) RAMP or APRON General parking, servicing and loading areas.
  - (2) PARK or PARKING Aircraft parking only areas.
  - (3) CIVIL Civilian areas of joint-use aerodromes.
  - (4) MIL Military areas of joint-use aerodromes.
  - (5) CARGO Freight or cargo handling areas.
  - (6) INTL International areas.
  - (7) DOM Domestic areas.
  - (8) RUNUP Run-up areas.
  - (9) ACP Altimeter Check Point.
  - (10) VOR VOR Check Point.
  - (11) FUEL Fuel or service areas.
  - (12) HGR Hangar or hangar areas.



Black on Yellow

- c. **Direction Sign.** A direction sign is normally installed before a taxiway intersection indicating the taxiways ahead.

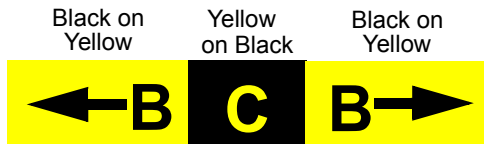

- d. **Runway Exit Sign.** A runway exit sign indicates the designation of the taxiway for aircraft exiting the runway. This sign is placed on the taxiway exit side of a runway.



Black on Yellow

- e. **Distance To Go Sign.** This sign is provided on runways used for LAHSO where a pilot may have difficulty seeing the intersecting runway during the landing roll due to an obstruction such as a hump in the landing runway. This sign is placed on the left hand side of the runway. The numbers shown indicate the distance in metres from the sign to the Hold Short Line.



Black on Yellow

*Note: Defence aerodromes also provide Distance To Go signs. The distance shown on these signs is in feet and is the distance from the sign to the end of the runway.*

**4.16 Aerodrome Mandatory Instruction Signs**

4.16.1 These signs have white lettering on a red background and must not be passed without clearance to do so from ATC. However, at an aerodrome where the control tower is not in operation, these signs may be passed at the discretion of the pilot. The following mandatory signs may be seen:

- a. **Taxi-Holding Position Sign at a Taxiway/Runway Intersection.** This sign consists of the designation of the runway and is placed abeam the taxi-holding position marking. A taxiway location sign is normally provided in conjunction with this sign. At a runway end, the taxi-holding position sign will show only the designation of the runway end concerned. At an intermediate taxiway, the taxi-holding position sign will show both ends of the runway designations. However, old taxi-holding position signs consisting of the word "HOLD" may still be seen at some aerodromes.



- b. **Taxi-Holding Position Sign at ILS Category I Runways.** At ILS Category I runways, an additional taxi-holding position sign may be seen further from the runway. This sign has the words "Cat I" besides the runway designation and will be illuminated when the aerodrome is operated under Cat I conditions.



White on Red

- c. **Taxi-Holding Position Sign at ILS Cat II Runways.** Where an ILS Cat II holding position exists at a runway/taxiway intersection, the taxi-holding position sign will have a Cat II inscription.



White on Red

- d. **Runway Intersection Sign.** This sign is normally provided at a runway used in LAHSO to show the designation of the intersecting runway. A sign is placed on both sides of the runway at the Hold-Short Line (75M to the intersecting runway centre line). These signs are illuminated for night operations. An ATC take-off or landing clearance constitutes clearance to pass such signs except when a landing clearance specifically directs that the aircraft hold short of the intersecting runway during the landing run.



- e. **Taxi-Holding Position Sign at Other Locations.** A taxi-holding sign may be installed at other than taxiway/runway intersections where there is a requirement for mandatory holding at that location.



- f. **Aircraft NO ENTRY Sign.** This sign is placed near an exit where entry is prohibited; e.g., at a one-way taxiway.



**5. LIGHTING**

**5.1 Permanent Threshold Lighting**

5.1.1 Permanent threshold lights are green and the following patterns are in use:

- a. Standard Pattern: a row of six lights evenly spaced across the threshold which may, at larger aerodromes, be augmented by one or two extra wing-bar lights at each end;
- b. Alternate Standard Pattern: two barrettes each of three lights, one each side of the threshold; and
- c. an obsolescent pattern of five or six lights which still exists on some runways.

5.1.2 The Alternate Standard Pattern is generally installed at aerodromes used predominantly by aircraft having a maximum take-off weight of less than 5,700KG.

5.1.3 At runways equipped with ILS, the Standard Pattern is used. When intensity stages 4, 5 or 6 are selected, this pattern is increased to give a 3M spacing between the lights.

5.1.4 Threshold lights across the runway show green in the approach direction only, except for the single lights on either side of the runway, in line with the runway edge lights, which are omni-directional.

**5.2 Runway Threshold Identification Lights (RTIL)**

5.2.1 Where a runway threshold needs to be made more conspicuous, two flashing white light (strobes) are provided, one on each side of the runway, in line with the threshold.

5.2.2 These lights flash at a frequency of between 60 and 120 flashes per minute and are visible in the approach direction only. They can be used in both day and night, and are occasionally used during daylight hours to indicate a temporarily displaced threshold.

*Note: When runway threshold identification lights are used to indicate a displaced threshold, V-bar markers may not be displayed.*

### 5.3 Displaced Threshold Lighting

5.3.1 Where the threshold is temporarily displaced, temporary displaced threshold lights are used to indicate the new threshold location at night. The pattern consists of two groups of five lights showing green, one group on each side of the runway. If the runway width is 30 M or less, groups of 3 lights per side may be used.

5.3.2 If any length of runway prior to the displaced threshold is available for taxiing or for take-off from that end of the runway, or for landing or take-off from the other end of the runway, the runway edge lighting on this part of the runway will show red in the direction of approach to the displaced threshold, and show white in the opposite direction (see Figure 24).

Figure 24 - Example of Displaced Threshold Lighting: Runway Before Displaced Threshold Serviceable

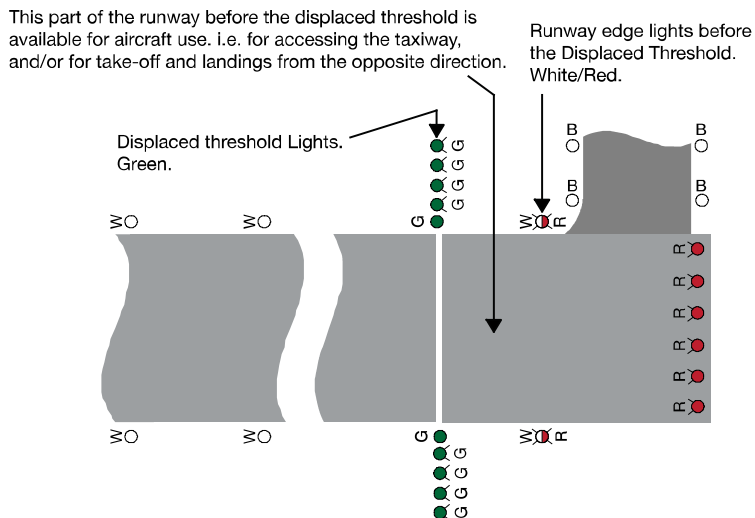

5.3.3 If the alteration to the threshold location is caused by an unserviceable area of the runway, all runway edge lights on this part of the runway will be extinguished. Unserviceability lights, showing red, will be placed across the runway at the entrance to the closed area. Work Limit lights, showing amber/yellow/orange, are provided to indicate to persons associated with the works organisation, the limit of the works area. (see Figure 25).

Figure 25 - Example of Displaced Threshold Lighting: Runway Before Displaced Threshold Unserviceable

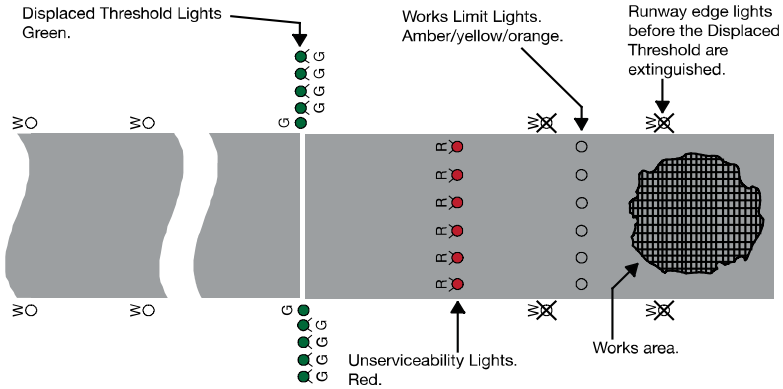

Note: Figure 24 and Figure 25 show examples of Displaced Threshold Lighting. They are not the only possible configurations.

5.3.4 For an aerodrome with scheduled international air transport operations, if a threshold is temporarily displaced then RTIL will be provided at the displaced location (except for an emergency).

Note: RTIL are also recommended for temporarily displaced thresholds on runways generally. RTIL must be used by day to mark a temporarily displaced threshold of a runway serving scheduled international air transport operations.

**5.4 Runway Edge Lighting**

5.4.1 Runway edge lighting has longitudinal spacing of 60M for instrument runways but may be up to 90M for non-instrument runways and for non-precision approach runways at country aerodromes.

5.4.2 Runway edge lights are white, except that in the case of a displaced threshold, they will show red in the approach direction.

5.4.3 For Precision Approach runway Category I or II the lights in the final 600M of the runway show yellow.

5.4.4 Runway edge lights are omni-directional on intensity stages 1, 2 and 3 in order to provide circling area guidance. Stages 4, 5 and 6 are unidirectional.

5.4.5 For runways less than 30M in width, the lateral spacing of runway edge lights is based on that of a 30M wide runway.

**5.5 Runway End Lighting**

5.5.1 Runway end lighting normally comprises six evenly spaced, uni-directional red lights. Where the runway end and the threshold are collocated, bi-directional red/green lights in either the Standard or Alternate pattern may be used.

### 5.6 Runway Centreline Lighting

5.6.1 Centreline lighting is colour-coded to be white from the threshold to a point 900M from the end of the runway, then alternate red and white to 300M from the runway end, and then red for the last 300M.

### 5.7 Runway Touchdown Zone Lighting

5.7.1 Touchdown Zone Lighting is provided for runways intended for precision approach Category II or III operations. The lighting consists of a series of 15 pairs of uni-directional, white barrettes for the first 900M of the runway. Six stages of intensity are available.

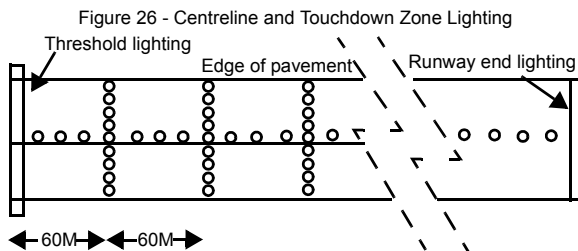

### 5.8 Partial Unserviceability Area Lighting

5.8.1 At aerodromes where night operations are permitted, the limits of unserviceable portions of the movement area are marked with steady red lights during the hours of darkness.

### 5.9 Stopway Lighting

5.9.1 Stopway lighting is provided where the runway is less than 1,500M. The lighting consists of side and end red lights, screened so as not to be visible to an aircraft approaching to land over the Stopway.

### 5.10 ADF - Lighting of runways

5.10.1 Runway lighting includes runway edge lighting, runway threshold lighting and runway end lighting. It must be capable of assisting operations in Runway Visual Ranges (RVR) down to 800M and a decision height of 200FT. Runway lighting also includes Distance to Run Marker (DTRM) lighting and Hook Cable Marker (HCM) lighting.

### 5.11 ADF - DTRM and HCM Lighting

5.11.1 DTRM and HCM are to be illuminated for use by night and by day in reduced visibility conditions. The illumination of the DTRM is to ensure readability from a maximum distance of 150M in a meteorological visibility of 900M. The illumination of the HCM is to ensure identification of the marker from a minimum distance of 450M in a meteorological visibility of 900M.

### 5.12 ADF - Aircraft Arrestor System (Net Barriers) Aiming Light

5.12.1 A flush mounted uni-directional aiming light may be incorporated as a centre light of the runway end lights where AAS barrier (net) facilities are provided. The light is to be activated only when the barrier is in the raised position.



5.13 ADF - Arrestor Barrier Lighting

5.13.1 Arrestor barriers are to be considered as obstructions. Obstruction lights are to be located at the top of each barrier arm. In addition uni-directional, flashing, red lights are to be mounted on frangible posts three feet high located just outside the barrier brake mechanism assembly. These warning lights are to be directed into the overshoot area to give pilots an indication that the downwind barrier has been accidentally or inadvertently raised, or that a landing is being attempted in the wrong direction. Both obstruction and warning lights are to be actuated by the barrier raising mechanism and are to operate continuously until the barrier is lowered.

5.14 Taxiway Lighting

5.14.1 Two types of taxiway lighting are used:

- a. **Edge Lighting:** fixed lights showing blue on both sides of the taxiway.
- b. **Centreline Lighting:** fixed lights showing green along the centreline of the taxiway.

5.14.2 **Apron Exit Lights.** Where there is an extensive system of taxiways, the taxiway lights at the exit from the apron are flashing the same colour as the taxiway lights.

5.14.3 **Runway Exit Lights.** On runway exit taxiways, the centreline taxiway lighting is extended to the runway centreline by lights spaced at 15M intervals. Alternate green and yellow lights are used for that section of the exit taxiway up to the taxi-holding position lighting.

5.14.4 **Rapid-Exit Taxiway Lights.** On rapid-exit taxiways, the centreline lighting is extended to the runway centreline by lights at 15M intervals. This spacing is continued until the high speed taxiway becomes incorporated into the normal taxiway system.

5.14.5 **Taxi-Holding Position Lighting.** Runway-holding position lighting consists of three lights showing yellow in the direction of the approach to the runway. When taxiway side lighting is provided, the runway-holding position lights consist of a pair of yellow lights in line with the holding point.

5.14.6 **Intermediate Holding Position Lights.** On a taxiway equipped with centreline lights, the intermediate holding position lights consist of at least three (3) lights showing yellow in the direction of the approach to the intermediate holding position marking or the taxiway intersection marking, as appropriate. When taxiway edge lighting is provided, the intermediate holding position lights consist of a pair of yellow lights in line with the runway holding position marking, intermediate holding position marking or taxiway intersection marking, as appropriate (see [Figure 27](#)).

Figure 27 - Intermediate Holding Position Lights

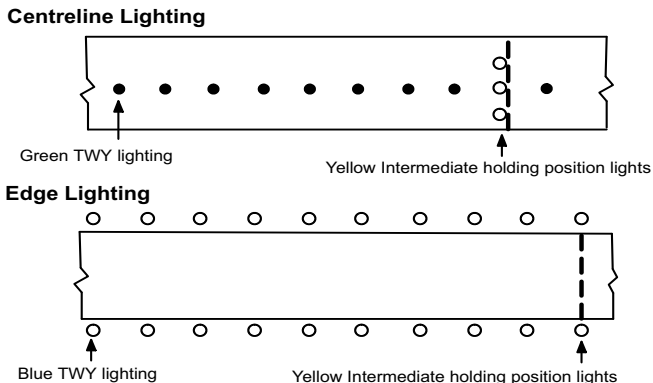

5.14.7 **Stop Bars.** A stop bar is unidirectional and shows red in the direction of approach to the stop bar from the taxiway. The stop bar lights are spaced 3M apart and 0.3M before the point at which it is intended that traffic approaching the runway must stop. The stop bar lights are at right angles to the taxiway centreline. When a stop bar is on at night or when Low Visibility Procedures are in force, any taxiway centreline lights immediately beyond the stop bar are switched off for a distance of at least 90M; once the stop bar is switched off the centreline lights beyond the stop bar are switched on.

Figure 28 - Stop Bar Lights

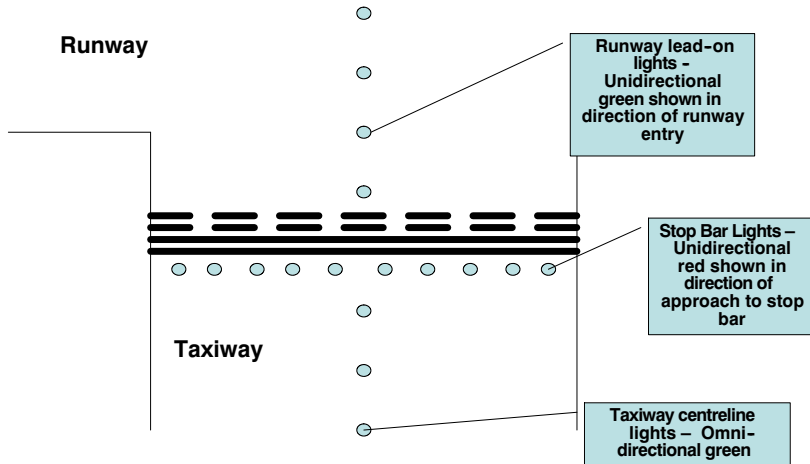

5.14.8 **Runway Guard Lights.** On standard taxiways, runway guard lights consist of a pair of alternating flashing yellow lights located either side of the holding position. On wide throat taxiways, runway guard lights consist of a line of flashing yellow lights spaced 3M apart across the taxiway at the holding position. All lights are unidirectional and visible to the pilot of an aircraft taxiing to the holding position. They are illuminated day and night.

5.14.9 **Hold-Short Lights.** Hold-short lights are installed on all runways used for LAHSO. The lights indicate the position of the hold-short line (no closer than 75M from the intersecting runway centre-line) and are additional to the runway intersections signs and hold-short position markings. They consist of a line of six white, unidirectional lights occulting at approximately 30 times per minute, installed across the runway. During LAHSO, the lights will be on and occulting, but an ATC clearance to take off, to land without a LAHSO instruction or requirement, or to cross the intersection after completing a LAHSO, constitutes a clearance to cross the lights. When issued with a land-and-hold-short instruction, a pilot must not permit the aircraft to pass the hold-short lights.

5.15 **Apron Lighting.** Apron floodlighting provides illumination on all apron service areas with a minimum of glare to users and a minimising of shadows.

5.16 Approach Lighting

5.16.1 There are several forms of approach lighting systems that may be used on a runway, depending on the type of runway and kinds of approach made to that runway.

5.16.2 For a non-precision approach runway or a non-instrument runway used at night, a simple approach lighting system (SALS) may be provided (see Figure 29).

Figure 29 - Simple Approach Lighting

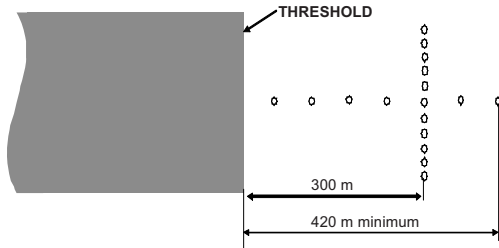

A Single source

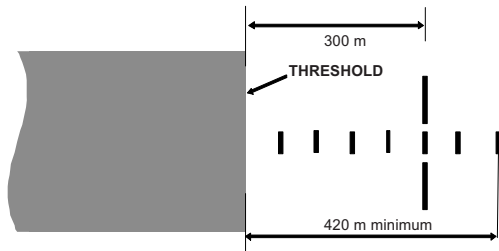

B Barrette

5.16.3 For a precision approach runway on which CAT I approaches are conducted, two types of approach lighting system may be provided:

- a. **Precision approach CAT I lighting system; distance coded centreline.** This type of approach lighting system is also known as the 'Calvert' system (see [Figure 30](#)).
- b. **Precision approach CAT I lighting system; barrette centreline.** This type of approach lighting system is also known as Approach Lighting System with Sequenced Flashing Lights (ALSF). As its other name implies, this type of approach lighting system includes a 'running rabbit' array of sequenced flashing lights (see [Figure 30](#)).

Figure 30 - Precision Approach CAT I Lighting System

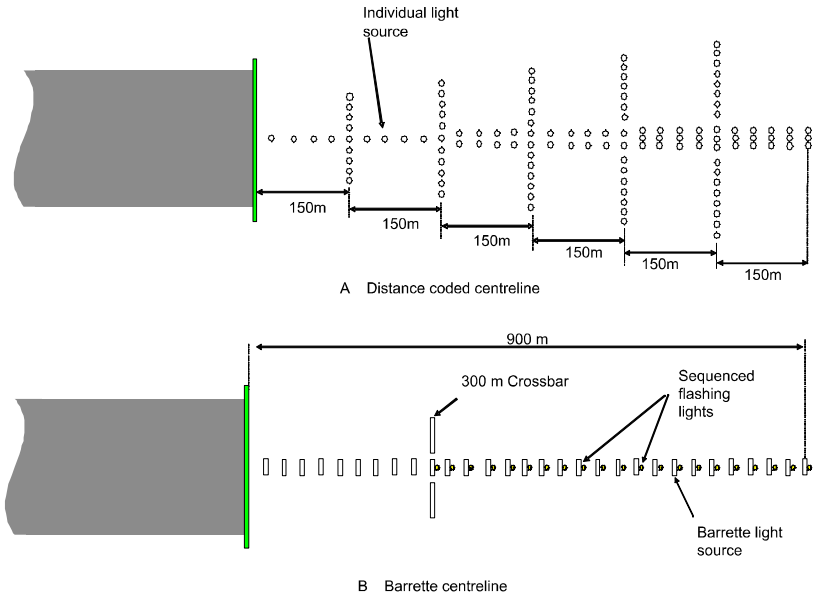

5.16.4 For a precision approach runway on which CAT II or III approaches are conducted an approach light system similar to one of the types shown in Figure 31 will be provided.

Figure 31 - Precision Approach CAT II and III Lighting System

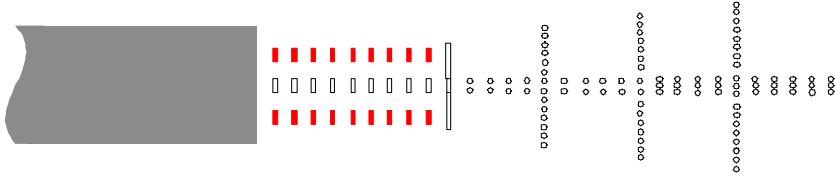

5.16.5 **Operation of Multi-stage Intensity Approach and Runway Lighting.** Precision Approach Runway lighting has five or six stages of intensity and other multi-stage systems have three. Intensity commences with Stage 1 with the first three common to all systems. Details are shown on the aerodrome landing chart. Multi-stage intensity approach and runway lighting is operated as follows:

- a. the initial intensity is normally selected by the tower controller;
- b. variation to the intensity is on pilot request with an expectation that the pilot will request a lower intensity as the aircraft nears the runway to reduce dazzle;
- c. pilots are advised when the equipment is operating in a visibility of 5,000M or less; and
- d. when requesting a change in intensity the pilot need only ask for a higher or lower stage.

INTENSITY TABLE		
Visibility	Intensity Stage	
	Day setting	Night setting
Not greater than 2,000M	6	4
Greater than 2,000M but not greater than 4,000M	5	3
Greater than 4,000M but not greater than 5,000M	4	2
Greater than 5,000M	-	1

### 5.17 Wind Direction Indicator Lighting

5.17.1 At aerodromes intended for night operations, the primary wind indicator, and maybe others, are illuminated. Unless indicated to the contrary in ERSA, wind direction indicator lighting is included in the PAL system.

### 5.18 Aerodrome Beacons

5.18.1 Aerodrome beacons are designed to be visible from at least 8KM at altitudes from 1,000FT to 5,000FT in restricted visibility.

5.18.2 Beacons may show white flashes alternating with green flashes or white flashes only. Beacon details are promulgated in ERSA.

5.18.3 At locations where an ATS unit is established, the beacon is operated at night and during conditions of reduced visibility, by day whilst the unit is open. When the aircraft traffic does not warrant continuous display, the beacon will be operated for known aircraft movements. The beacon is available on request.

### 5.19 Obstacle Lighting

5.19.1 At an aerodrome where night operations are permitted, constructed obstacles and significant terrain which penetrate the obstacle limitation surface of an aerodrome, or which are on the movement area, are obstacle-lit unless shielded by an obstacle which is already lit. Three types of lights are used:

- a. low intensity STEADY RED light for most situations;
- b. medium intensity FLASHING RED light (hazard beacon) for early or special warning; and
- c. flashing WHITE (strobe) light for day/night marking of tall structures.

5.19.2 In areas away from aerodromes, constructed obstacles that would be marked in accordance with [paragraph 5.19.1](#) above will normally be lit.

### 5.20 General Aviation Aircraft Lanes of Entry

5.20.1 Certain light aircraft lanes located near major airports have strobe lights that mark the centreline of the lane. These lights are depicted on the appropriate Airservices Australia VTC.

### 5.21 Pilot Activated Lighting (PAL)

5.21.1 PAL installations provide a means to activate aerodrome, runway, taxiway, apron, VASIS and wind indicator lighting. Aerodrome lighting enabled by a PAL system is available only during night hours or at other times of low natural light levels. By day, when the light intensity is above a pre-set level, the system will not activate the lights. However, where an aerodrome is equipped with a VASIS, activation of the PAL during daylight hours will activate the VASIS only.

5.21.2 It is recommended that pilots activate the lighting before taxi or within 15NM of the aerodrome. The lights will illuminate for a minimum of 30 minutes, depending on the installation timer setting. The wind indicator light will flash continuously during the last 10 minutes of lighting illumination to warn users that the lights are about to extinguish. To maintain continuity of lighting, repeat the activation sequence.

5.21.3 PAL systems may provide an audio acknowledgment (PAL+AA) of lighting operation. For systems with an audio acknowledgment capability the expected responses on the PAL frequency are:

"[aerodrome name] AERODROME LIGHTING ON"

"[aerodrome name] LIGHTS 10 MINUTES REMAINING"

"[aerodrome name] AERODROME LIGHTING NOT ACTIVATED"

5.21.4 At aerodromes with AFRU, PAL operation may be provided as an optional function of an AFRU (on the associated aerodrome CTAF) and is referred to as AFRU+PAL. Expected responses on the CTAF are:

"[aerodrome name, CTAF message] RUNWAY LIGHTS ON"

"[aerodrome name, CTAF message] NO RUNWAY LIGHTS"

**5.22 Visual Guidance and Information**

5.22.1 **Visual Approach Slope Indicator System (VASIS).** Two types of VASIS are approved for use in Australia: T-VASIS, a high intensity system for use by day or night; and Precision Approach Path Indicator (PAPI), a colour discrimination system usable by day or night. The standard installation aims to provide an obstacle clearance of at least 11M above a 1.9° slope, within the azimuth splay of 7.5° either side of the runway centreline for a distance of 5NM from the threshold (7NM for a runway equipped with an ILS). When the installation differs from the standard, details are promulgated in the aerodrome documentation.

5.22.2 **T-VASIS.** The cross-bar indicates on-slope and deviations appear as one, two or three lights above or below the cross-bar. The sensitivity is similar to the "dot-positions" on an ILS glide path. Increased eye-height over the threshold can be achieved by flying the approach with one or more of the "fly-down" lights visible.

APPROACH SLOPE INDICATION	EYE HEIGHT ABOVE THRESHOLD
3 lights fly up	0 - 7FT
2 lights fly up	7 - 25FT
1 light fly up	25 - 41FT
<b>ON GLIDE SLOPE</b>	<b>49FT</b>
1 light fly down	57 - 75FT
2 lights fly down	75 - 94FT
3 lights fly down	94 - 176FT

*Note 1: The night azimuth splay is normally increased to 30° to permit T-VASIS to be visible on base leg. However, obstacle clearance is not guaranteed until the aircraft is within the runway approach obstacle limitation surface. Accordingly, T-VASIS should not be used for approach slope guidance until the aircraft is aligned with the runway.*

*Note 2: Presence of a thin layer of ground fog or mist may produce abnormal T-VASIS indications, including:*

- a. *erroneous fly-down or fly-up signals; or*
- b. *other fly-up or fly-down lights together with the correct lights (which are usually much brighter than the erroneous lights).*

*Consequently, pilots should exercise caution when using the T-VASIS in ground fog or other conditions conducive to light reflection or refraction.*

The above requirements may vary by 15FT depending on the location of the system.

The intensity of the system may be varied at the request of the pilot.

An abbreviated version of T-VASIS (AT-VASIS) is used at some locations, with the equipment located on only one side of the runway (usually the left).

Figure 32 - T-VASIS Signals

Above Approach Slope

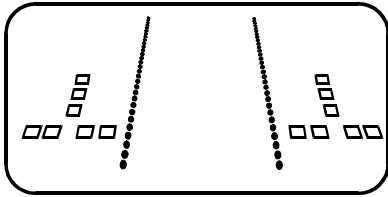

FLY DOWN

Below Approach Slope

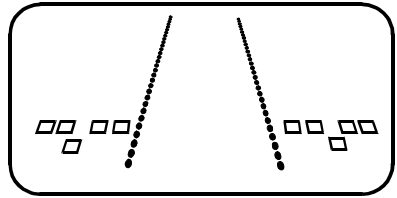

FLY UP

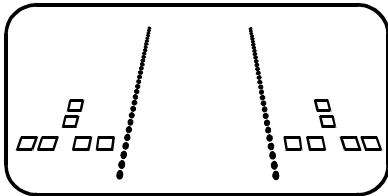

FLY DOWN

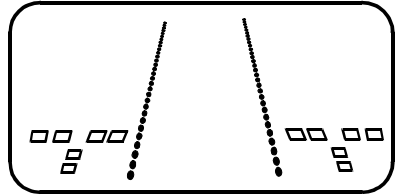

FLY UP

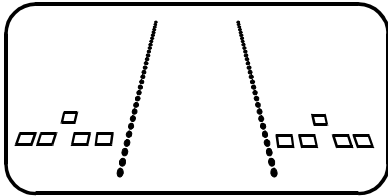

FLY DOWN

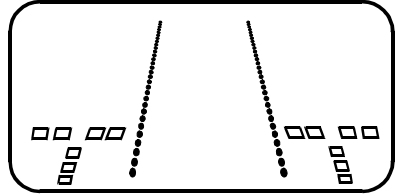

FLY UP

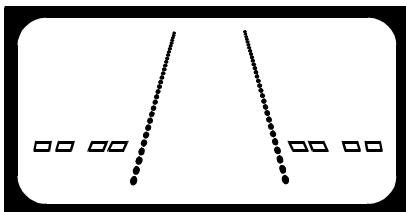

ON CORRECT APPROACH SLOPE

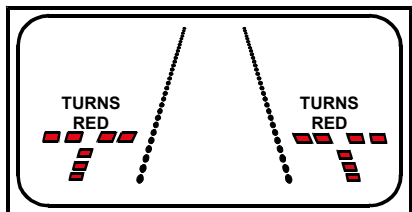

GROSS UNDERSHOOT



5.22.3 **PAPI.** An installation consists of a set of four light boxes placed in a line at right angles to the runway, abeam the touchdown point and usually on the left hand side. Each box radiates both red and white light. The transition between the red and white will appear instantaneous to the pilot (3 minutes of arc change); however, light changes between adjacent boxes will not occur unless the approach slope changes by about 0.25°. A 1° progressive incremental spread from the outermost to the innermost light unit about the standard approach angle provides the visual guidance shown in [Figure 33](#).

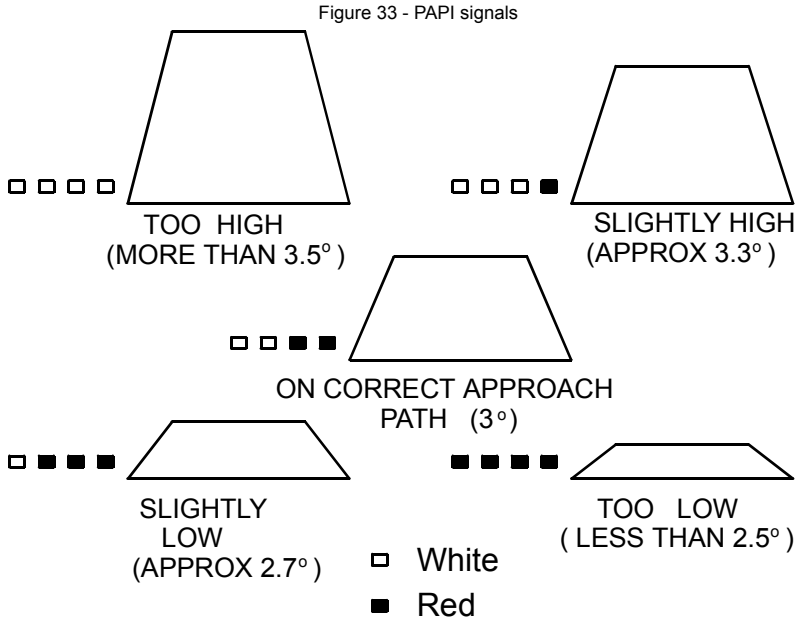

The correct approach slope is shown to a ±10' tolerance when two red and two white lights are seen. The two red indication is always closest to the runway, irrespective of which side the PAPI is installed.

Unlike T-VASIS, PAPI is a point source aid. Thus, a non-standard approach will not significantly alter the threshold crossing height; only the approach angle will change. This is illustrated in [Figure 34](#).

Figure 34 - PAPI/T-VASIS Comparison

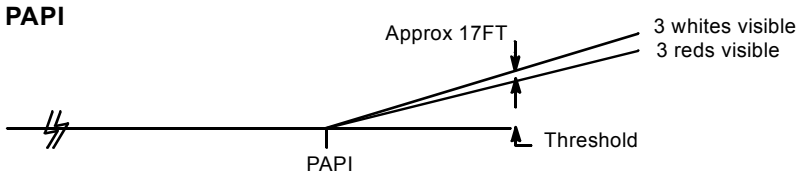

AIMING POINTS: Same

APPROACH ANGLES: Different (by up to  $1^\circ$  between the approaches illustrated)

THRESHOLD CROSSING

HEIGHTS: Small differences  
(approx 17FT between the approaches illustrated)

FOUR WHITES: HIGH ON APPROACH

## T-VASIS

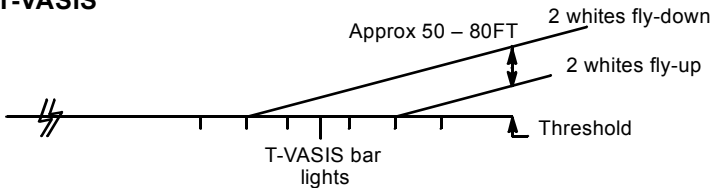

AIMING POINTS: Different

APPROACH ANGLES: Very small differences

THRESHOLD CROSSING

HEIGHTS: Large differences possible  
(approx 50FT between the approaches illustrated)

FOUR (BAR) WHITES: ON-SLOPE

*Note: An aircraft descending through the PAPI signals into the four red zone will receive no additional clues as to further downward displacement from the approach slope - the four reds may remain visible to ground level.*

Since the meaning of a four-white PAPI indication is significantly different to the same T-VASIS indication, pilots should verify which system is installed prior to conducting an approach.

Condensation on PAPI lenses is known to be a cause of colour distortion. Therefore PAPI systems should be activated at least 10MIN prior to use so that any condensation that may have formed on the lenses is evaporated before use.

5.22.4 **VASIS Control.** When controlled by ATS, the operation of the relevant VASIS will be activated as follows:

- a. whenever night landing facilities are activated;
- b. by day, for all approaching military aircraft; and
- c. by day, on request by other aircraft.

When PAL is used to activate the runway lighting, the VASIS at both ends of the runway will be activated unless otherwise indicated in ERSA or NOTAM.

#### 5.22.5 **Wind Direction Indicators**

5.22.5.1 At least one wind direction indicator is provided on each certified aerodrome.

5.22.5.2 The primary wind indicator, coloured white, is located near the terminal. Other wind indicators are coloured yellow and those serving a particular runway are located upwind of the runway threshold on the left side.

#### 5.22.6 **Segmented Circle**

5.22.6.1 A Segmented Circle visual indicator system is one method that may be used to provide circuit information at some non-controlled aerodromes. Circuit indicators are placed in pairs at opposite sides of the segmented circle to indicate runway alignment and circuit direction for each set of reciprocal runways.

5.22.6.2 The segmented circle may be based around the primary wind indicator at an aerodrome. Markings that may be placed upon the segmented circle include "Circuit Indicators". These indicators are used for the purpose of controlling the direction of the circuit when there is any variation from the normal left hand circuit.

### 6. VISUAL DOCKING GUIDANCE SYSTEMS

6.1 Visual Docking Guidance Systems (VDGS) used in Australia include:

- a. The generic Nose-In-Guidance (NIG) system
- b. Aircraft Positioning and Information System (APIS)
- c. Safegate Docking Guidance System

6.2 An aerodrome's DAP Apron Chart specifies the bays/stands equipped with VDGS and the particular system installed.

#### 6.3 **Nose in Guidance (NIG) System**

6.3.1 This system is identified on DAP charts either as 'NIG' or 'Centreline+Sidemarker'. It includes the following elements:

- a. Position Identification Light
- b. Aerobridge Retracted Indicator
- c. Centreline Guidance Light unit
- d. One or more Side Marker Light units.

6.3.2 The following is a brief description of the system:

- a. The Position Identification Light indicates the number of the docking position and is white numerals on a dark background (illuminated at night).
- b. The Aerobridge Retracted Indicator consists of two lights. The green light indicates the Aerobridge is in the fully retracted position. The red light indicates that the Aerobridge is not fully retracted or that an element of the visual guidance docking system is unserviceable.
- c. The Centreline Guidance Light provides azimuth information and is aligned with the left pilot position. The unit emits RED/ GREEN light beams and the signals are interpreted as shown in [Figure 35](#).

Figure 35 - Centreline Guidance Light Unit

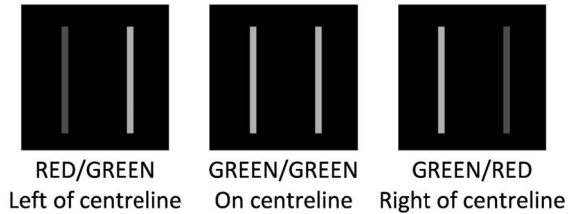

- d. One or more Side Marker Light units – with relevant aircraft types marked on the unit – indicate the stopping position as described below:
- (1) Approaching the position, a preliminary dull GREEN light will show through the arrow-shaped aperture which also exhibits a cross bar.
  - (2) As the aircraft moves forward, the intensity of the green light increases until it becomes a bright arrow-head.
  - (3) As the aircraft continues, the arrow-head starts to reduce in size.
  - (4) When the arrow-head disappears, two white bars appear, one above the other, indicating the stopping position. In some installations, two sets of bars will appear.
  - (5) If the stopping position is passed, then a single RED bar appears.

Figure 36 - Side Marker Lights



#### 6.4 Aircraft Positioning and Information System (APIS)

6.4.1 APIS is based on a centreline guidance sub-display. The steering and stop indication is provided from a display unit mounted on a pole in front of the cockpit in line with the left hand pilot seat. The parking bay position identification is mounted on top of the guidance pole.

6.4.2 On approach to the parking position, the pilot will see the display box face showing two rows of yellow alpha-numeric characters on a black background across the top, an illuminated closing-rate 'thermometer' at lower left, and an illuminated azimuth guidance display at lower right. The alpha-numeric characters on the top row should be flashing (see diagram at [Figure 37](#)).

6.4.3 The following is the sequence of APIS operation from initial approach to STOP:

- a. Identify the correct parking bay position.
- b. Ensure that the aerobridge retraction light indicates green.
- c. Follow the taxi-in line and watch the centreline beacon.
- d. Check that the correct aircraft type is flashing and that the door number is shown (where applicable).
- e. About 20M before STOP, the aircraft type display goes steady and the door number disappears.

- f. Follow the azimuth guidance display. The black arrow heads indicate which direction to steer for the centreline. When the aircraft is properly aligned in azimuth, the black vertical bar will be displayed.
- g. The full closing rate 'thermometer' indicates at least 13M to STOP.
- h. When the aircraft reaches 13M to STOP, the 'thermometer' bar lights begin to move from bottom to top.
- i. The deletion of each 'thermometer' bar indicates about one half metre progression.
- j. When the STOP position is reached, all the closing rate 'thermometer' lights extinguish and the lower display indicates STOP. If the aircraft is parked correctly, the top display indicates OK.
- k. If the aircraft overshoots the limit for correct parking, the top display indicates TOO FAR (alternating TOO then FAR).
- l. The entire display automatically shuts down after some seconds.

*Note: When the last row of lights of the closing rate 'thermometer' is extinguished and the word STOP is displayed, the aircraft should be at a standstill.*

Figure 37 - APIS++ VDGS - Typical Configuration

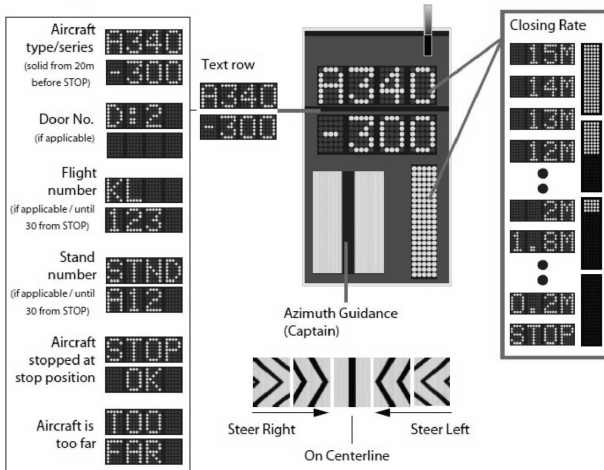

*Note: Some APIS++ installations have a single row of text information.*

**6.5 Safegate Docking Guidance System (DGS).**

6.5.1 The Safegate Docking Guidance System (DGS) is the most common VDGS in use in Australia. The complete system consists of the following three elements:

- a. Position Identification Unit (Bay Marker);
- b. Aerobridge Retracted Indicator Light; and
- c. DGS NIG Unit.

6.5.2 The Position Identification Unit gives clear indication of the parking bay for the aircraft. It consists of large white numerals on a dark background (illuminated at night).

6.5.3 The Aerobridge Retraction Indicator Light, mounted on the aerobridge, gives an early warning of the state of aerobridge location. Green indicates a fully retracted aerobridge position or a safe pre-parked

position; red indicates that the aerobridge is out of position and the pilot should not proceed with parking the aircraft.

6.5.4 The NIG unit, mounted on the Terminal wall, consists of two components which supply the following information to the pilot:

- a. The top alphanumeric information display which shows aircraft type designation, and other message information as necessary in yellow.
- b. The azimuth and centreline guidance displays in red and yellow and the Closing Rate Bar in yellow.

6.5.5 The following is the sequence of system operation from initial approach to STOP:

- a. The pilot identifies the correct parking bay position.
- b. The pilot ensures that the aerobridge retraction light is green.
- c. The pilot observes that the rising vertical yellow arrows are indicating the system is activated and searching for the approaching aircraft.

*Note: The pilot must not enter the stand area unless the rising vertical arrows are displayed.*

- d. The pilot follows the taxi-in line and checks that the correct aircraft type is displayed in yellow.

*Note: The pilot must not enter the stand area unless the correct aircraft type is displayed.*

- e. On successful capture of the aircraft, the vertical arrows are replaced by the yellow T-shaped Closing Rate Bar.

*Note: The pilot must not proceed to the bridge unless the arrows have been superseded by the Closing Rate Bar.*

- f. A vertical yellow arrow shows the aircraft position in relation to the centreline.
- g. A flashing red arrow indicates the direction to turn to return to the centreline.

*Note: If the aircraft is approaching faster than the accepted speed, the system will show SLOW DOWN as a warning.*

- h. The display of the yellow digital closing rate countdown will start when the aircraft is 20M from the STOP position.

*Note: If the detected aircraft is lost prior to 12M to STOP, the display will show WAIT. The docking will continue as soon as the system detects the aircraft again.*

- i. When the aircraft is 12M from the STOP position, the Closing Rate Bar will decrease in size from the bottom by one row of lights per 0.5 metre closing rate.

*Note: If the detected aircraft is lost after 12M to STOP, the display will show STOP and ID FAIL. Assistance must then be sought from the ground engineers.*

- j. When the correct STOP position is reached, the display shows STOP and red lights will be lit.
- k. When the aircraft has parked, OK will be displayed.
- l. If the aircraft has overshot the position, TOO FAR will be displayed.
- m. When ground engineers have placed the chocks at the nosewheel, they will manually change the display to CHOCK ON.
- n. During heavy rain or fog, the visibility for the docking system might be reduced. When the system is activated and in capture mode, the display will deactivate the rising vertical arrows and show DOWN GRADE. This text will be superseded by the Closing Rate Bar once the aircraft is detected.

*Note 1: The pilot must not continue the approach to the bridge unless the DOWN GRADE text has been superseded by the Closing Rate Bar.*

*Note 2: Ground engineers have access to emergency push-buttons to deactivate the system. When an emergency stop is activated, the display will show STOP. The ground engineers will then be required to complete the docking manually once the emergency situation is cleared.*

Figure 38 - Typical Safegate Indications - Normal Operations

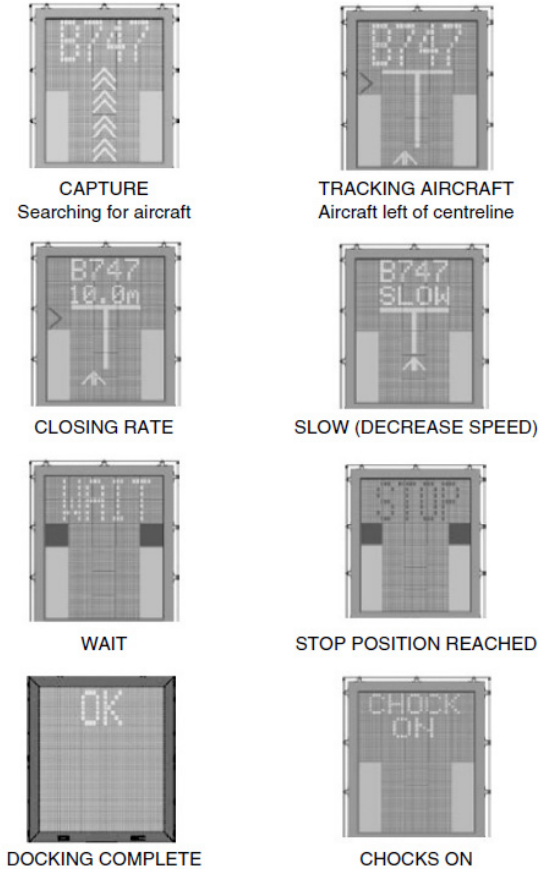

**7. PAVEMENT STRENGTH LIMITATIONS**

**7.1 General**

7.1.1 The Aircraft Classification Number/Pavement Classification Number (ACN/PCN) method is used to specify the strength of pavements and hence permissible aircraft masses.

- a. **ADF** - Technical advice on pavement classification may be sought from Civil Engineering Policy and Planning, details on [paragraph 7.5.2](#).

*Caution- **ADF** - If any doubt exists regarding the accuracy of a pavement classification, the aircraft captain is to use every means at their disposal to validate the information, prior to the proposed operation proceeding.*

7.1.2 The operation of an aircraft above the maximum masses and tyre pressures is not permitted unless a pavement concession is approved.

*Note: **ADF** - When seeking pavement concessions, aircraft captains must bear in mind that civil aerodrome owners may not be aware of the nature of ADF aviation operations. The issue of a pavement*

*concession does not absolve aircraft captains of their responsibility for the safety of the aircraft or for the prevention of damage to the pavement of an airfield.*

7.1.3 This paragraph from Airservices Australia AIP not applicable to ADF.

7.1.4 Operators of non-scheduled aircraft requiring to park on aprons used by scheduled services should check parking availability with the Aerodrome Operator at least 48HR before the operation.

### 7.2 Information Published for Rated Pavements

7.2.1 The parameters published to specify the strength of a pavement suitable for use by aircraft above 5,700KG maximum all up mass are:

- a. Pavement Classification Number (PCN)
- b. The pavement type:
  - R Rigid Pavement
  - F Flexible Pavement
- c. The subgrade strength in four standard categories:
  - A High Strength
  - B Medium Strength
  - C Low Strength
  - D Ultra-low Strength
- d. The maximum allowable tyre pressure category
  - W High - no pressure limit
  - X Medium - pressure limited to 1.50 MPa (218 PSI)
  - Y Low - pressure limited to 1.00 MPa (145 PSI) [International Usage]
  - Y1 Low - pressure limited to 1.00 MPa (145 PSI)
  - Y2 Low - pressure limited to 0.80 MPa (116 PSI)
  - Z Very Low - pressure limited to 0.50 MPa (73 PSI)

1 MPa = 1,000 kPa
- e. The method by which the pavement has been evaluated:
  - T by Technical Evaluation
  - U from Aircraft Experience

7.2.2 The parameters published for pavements suitable for use by aircraft not above 5,700KG maximum all up mass are:

- a. the permissible aircraft gross mass in KG; and
- b. the maximum tyre pressure in KPA.

### 7.3 Determination of Pavement Strength Suitability - Rated Pavements

7.3.1 Compare the aircraft tyre pressure with the maximum listed for the pavement:

- a. If the tyre pressure does not exceed that listed, proceed to [paragraph 7.3.2](#).
- b. If the tyre pressure exceeds that listed the permissible pressure may be increased using the factor obtained in [Figure 39](#) up to a limit of 1,400KPA. If the pressure requirements are then met, and provided that not more than four movements within a seven day period are proposed for aircraft above 5,700KG maximum gross mass, the user should proceed to [paragraph 7.3.2](#).



Figure 39 - Permanent Tyre Pressure Concessions

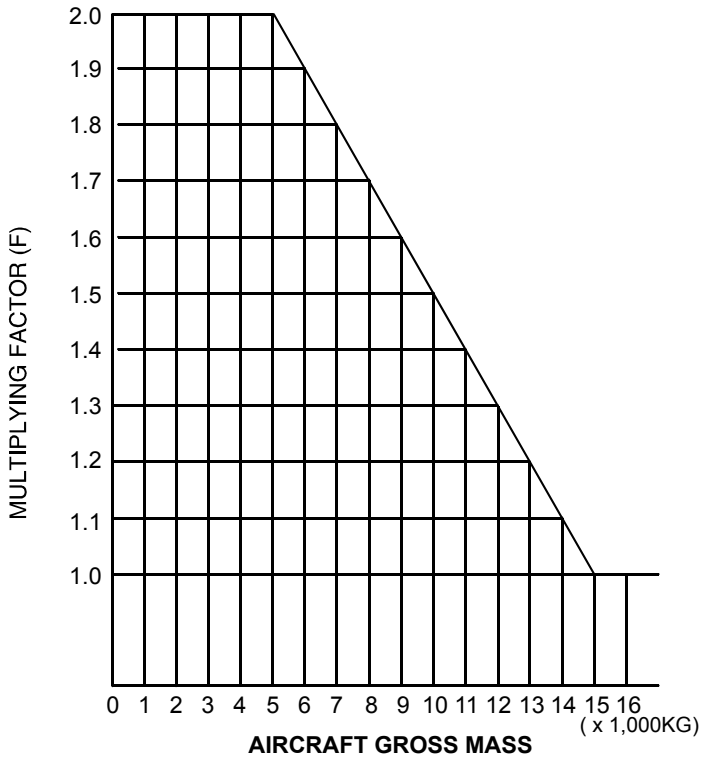

7.3.2 An aircraft may use a pavement if its ACN for the appropriate type and subgrade strength does not exceed the published PCN, as illustrated in the following example:

Aircraft: B727-200; gross mass 80,000KG and 1035KPA tyre pressure.

Pavement: PCN 40/F/A/1050/T.

- a. The tyre pressure, 1035KPA, is not above the maximum allowable, so no tyre pressure restriction applies.
- b. As shown by the dashed line in [Figure 40](#), the ACN at a gross mass of 80,000KG on a flexible pavement with category A subgrade is 42.8.
- c. The ACN is greater than the PCN and the operation should not take place (except with a pavement concession approval from the aerodrome operator - see [sub-section 7.5](#))
- d. The maximum permissible gross mass can be determined as shown by the dotted line on [Figure 40](#), i.e., the maximum permissible ACN is the PCN (40), and the maximum gross mass is then determined (75,300KG).

Figure 40 - Example B727-200 ACN Graph

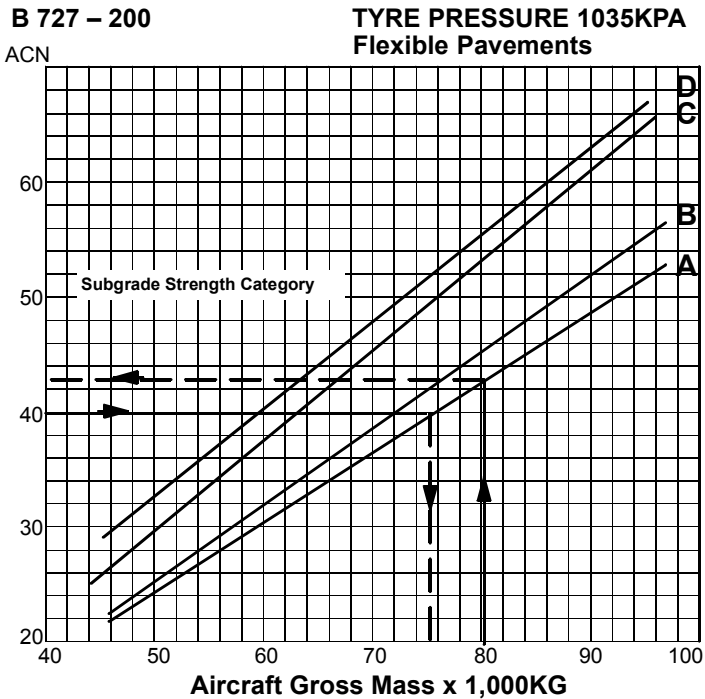

**7.4 Determination of Pavement Strength - Unrated Pavements**

7.4.1 An aircraft may operate on an unrated pavement, provided that the aircraft gross mass and tyre pressure do not exceed that determined in Figure 41.

Figure 41 - Aircraft Suitability for Unrated Pavements

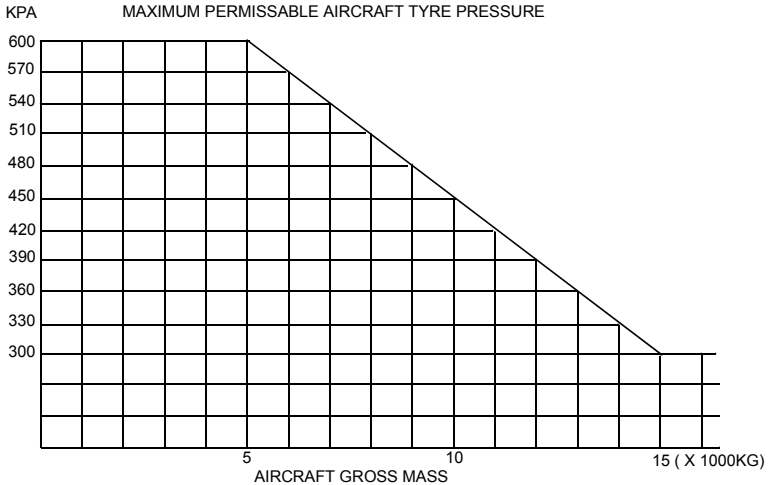

**7.5 Pavement Concessions**

7.5.1 The operator of an aircraft requiring a pavement concession should apply to the airport operator (see ERSA).

7.5.2 **ADF** - The operator of an aircraft requiring a pavement concession for Defence airfields should apply to:

- a. Civil Engineering Section  
 Environment and Engineering Branch  
 Defence Estate and Infrastructure Group  
 ☎ +61 2 6266 8207/8183  
 MOB: +61 405 228 962  
 FAX: +61 2 6266 8211  
 E-mail: [adf.ces@defence.gov.au](mailto:adf.ces@defence.gov.au)

**7.6 Care of Pavements**

7.6.1 Pilots should avoid running aircraft wheels close to edges of pavements or on to the shoulders of either runways or taxiways.

7.6.2 Tight turns on runways should be avoided and turning nodes, where provided, should be used. Locked wheels, in particular, should be avoided.

**7.7 ADF - Information Published for Rated Military Pavements**

7.7.1 The aircraft pavement rating system used in Australia for ADF aerodromes is known as ADF - Aircraft Pavement Strength Evaluation Manual (previously known as RAAF Evaluations). This system is based on a detailed analysis of all pavements at defence aerodromes and provides a separate rating for each pavement area at the aerodrome.

7.7.2 The ratings are to be used for the control of all aircraft operations at ADF aerodromes. The airfield data shown in [Figure 42](#) shall be used for determining pavement suitability for aircraft operations.

*Note: The information contained in [Figure 42](#) was provided by the Defence Estate Organisation and addresses only pavement strengths of the main runways and associated taxiways and aprons. The full RAAF ratings provide data for pavements of lesser strength. No account is taken of the operational limitations imposed on aircraft by consideration of factors such as runway lengths or widths, airspace or by obstacles.*

7.7.3 To determine the maximum mass for operations with unlimited frequency (tonnes) at which an aircraft can operate at one of the airfields listed in [Figure 42](#) proceed as follows:

- a. Identify the required aircraft type on the table.
- b. Read horizontally across the table to the required airfield and read off the maximum allowable gross mass.
- c. "+" indicates that the aircraft can operate at its maximum mass with no limitation on the frequency of operations.
- d. "0" indicates that the aircraft cannot operate at the airfield without restrictions on the frequency of operations because either:
  - (1) the aircraft minimum mass exceeds the permissible mass; and/or
  - (2) the aircraft tyre pressure exceeds the maximum allowable.
- e. "264.5" indicates that the aircraft mass must be limited to 264.5 tonnes when operating without restrictions on the frequency of operations on the high strength pavements at this aerodrome.





7.8 ADF- Load Classification Number (LCN) System

7.8.1 The Load Classification Number (LCN) system expresses the designed strength of a pavement. To operate an aircraft on a pavement using this system without requiring a pavement concession, an aircraft's calculated LCN must be less than the pavement's published LCN.

7.8.2 The LCN value for an aircraft is calculated using LCN graphs, as illustrated in the following example:

Aircraft: DHC4 Caribou, All Up Weight (AUW) 20,000 LB, Tyre Pressure 40 PSI  
Pavement: LCN 5, Pavement Depth Factor (PDF) 16 inches

- a. Enter graph at AUW (20) and parallel line to intercept PDF (16) extended vertically. Move horizontally to obtain LCN. This gives an aircraft LCN of 4.2, which is less than the pavement LCN of 5. The operation may proceed.
- b. Reversing the process, with a known (published) LCN/PDF, permits the maximum allowable AUW for operations to be determined.

Figure 43 - Example DHC4 LCN graph

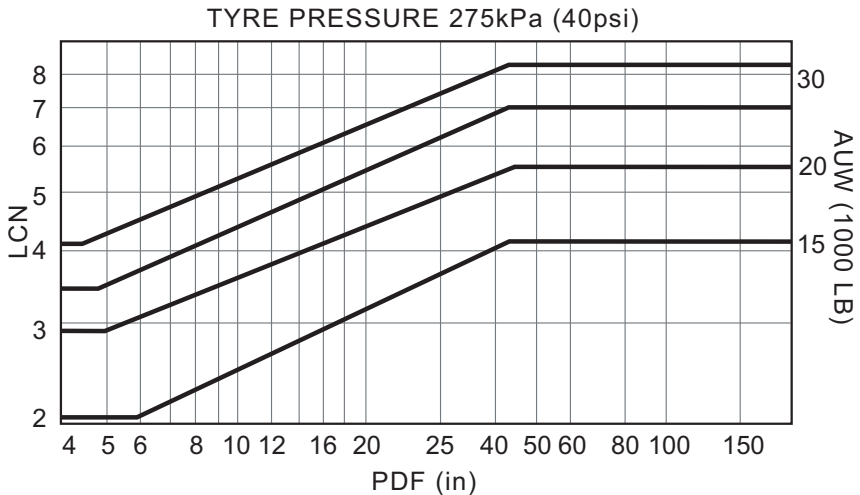

7.8.3 LCN graphs for the AP-3C Orion are on page 74.

7.8.4 A conversion graph for tyre pressure, LCN and Single Isolated Wheel Loading is provided at [Figure 44](#).

Figure 44 - TP/LCN/SIWL Conversion

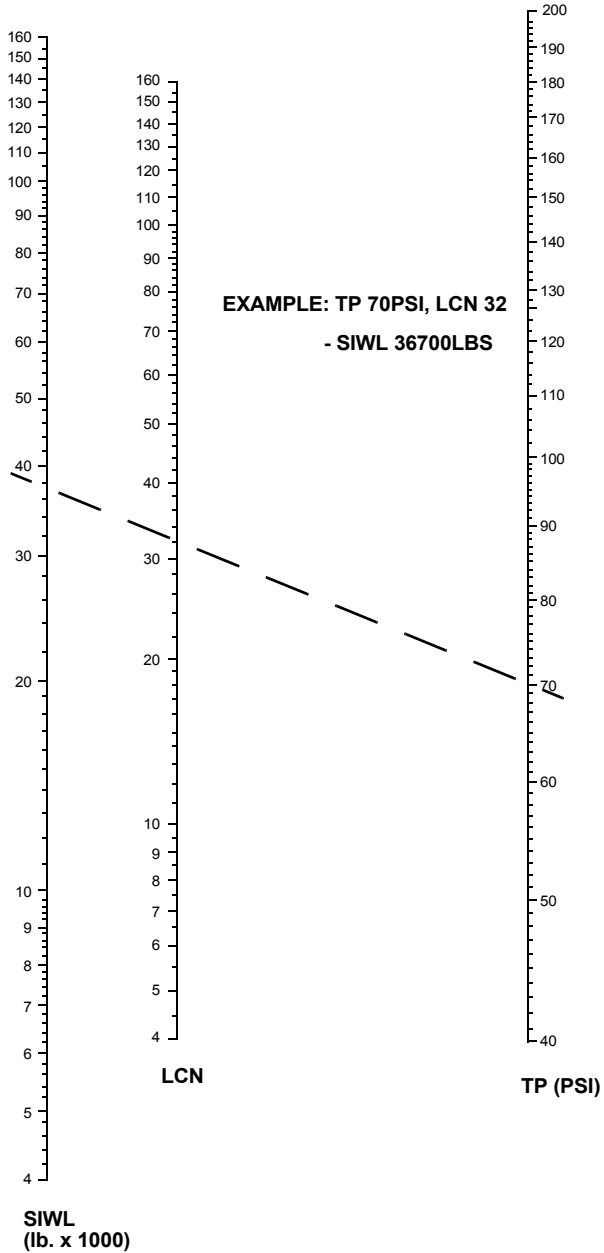



### 8. ACN/PCN & LCN GRAPHS

#### 8.1 Boeing 737 BBJ

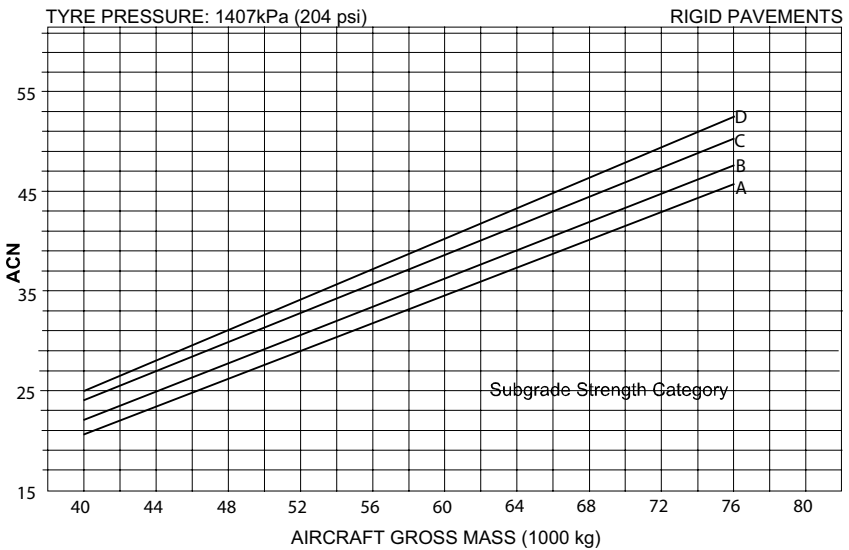
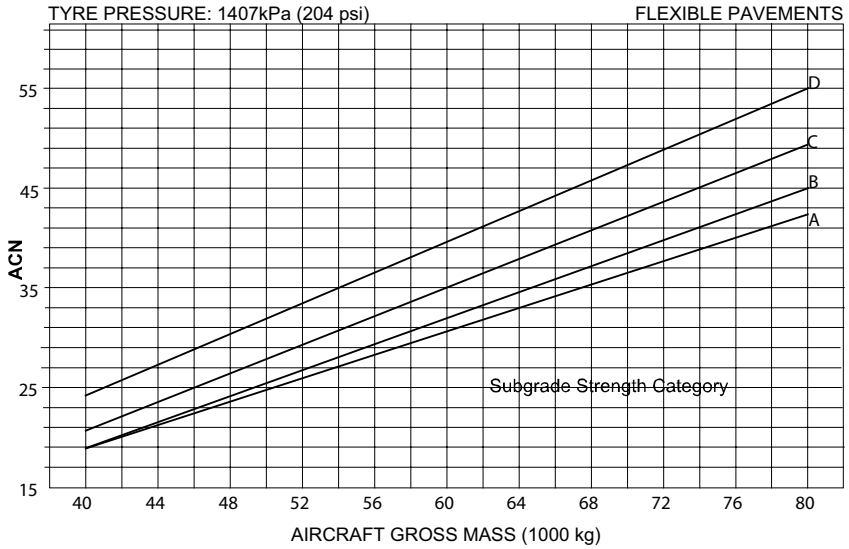

8.2 Model 737-8 / -8-200 / BBJ MAX 8

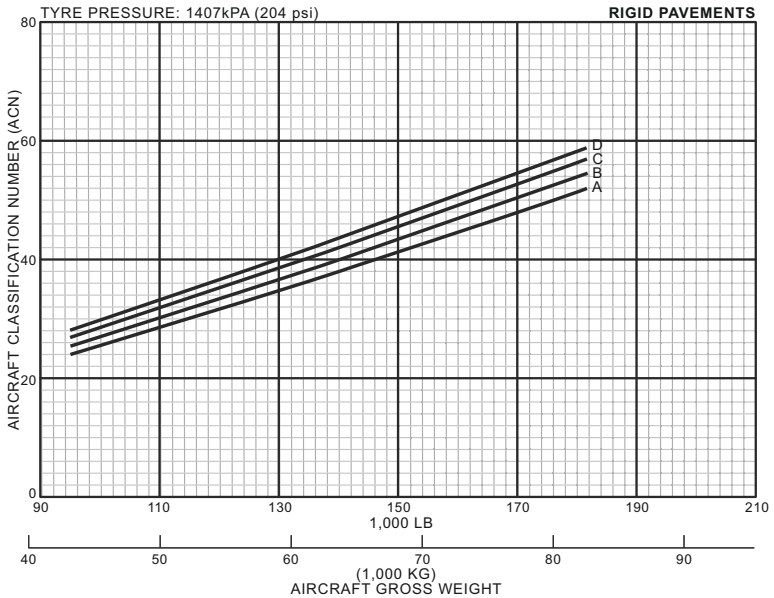
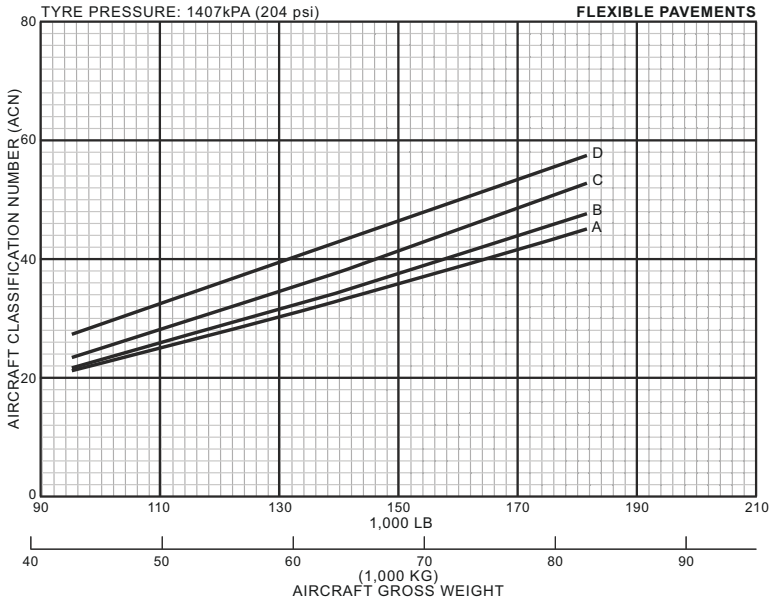

### 8.3 C-17A Globemaster

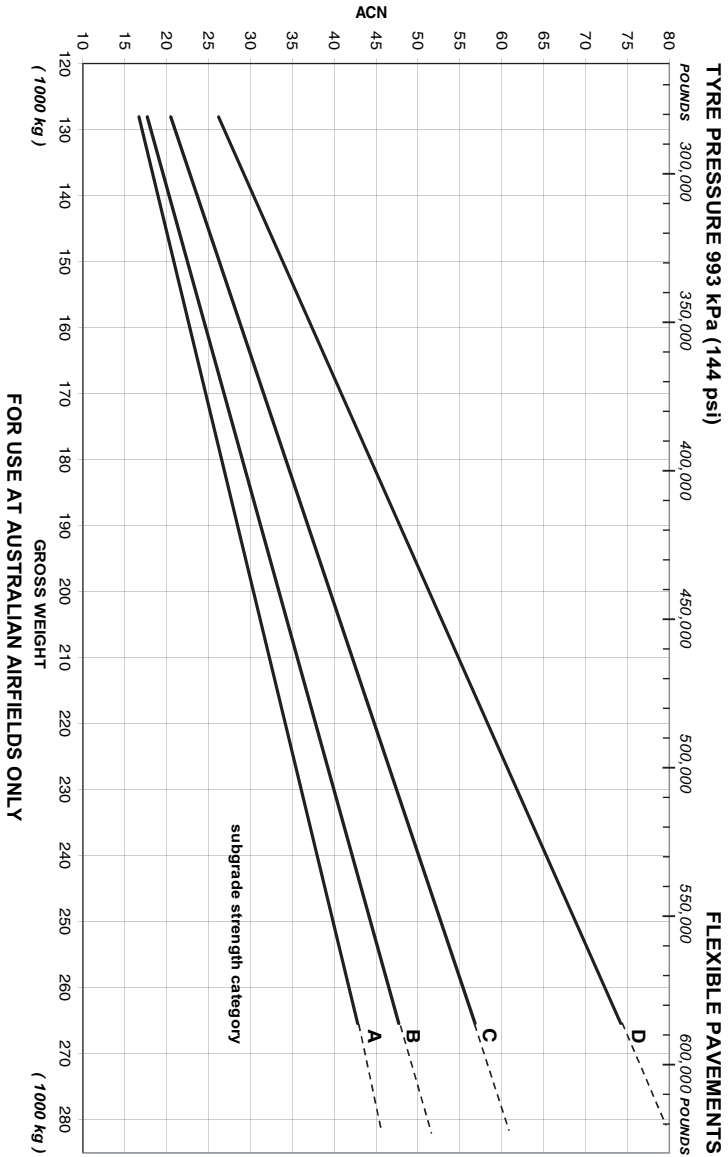

C-17A Globemaster

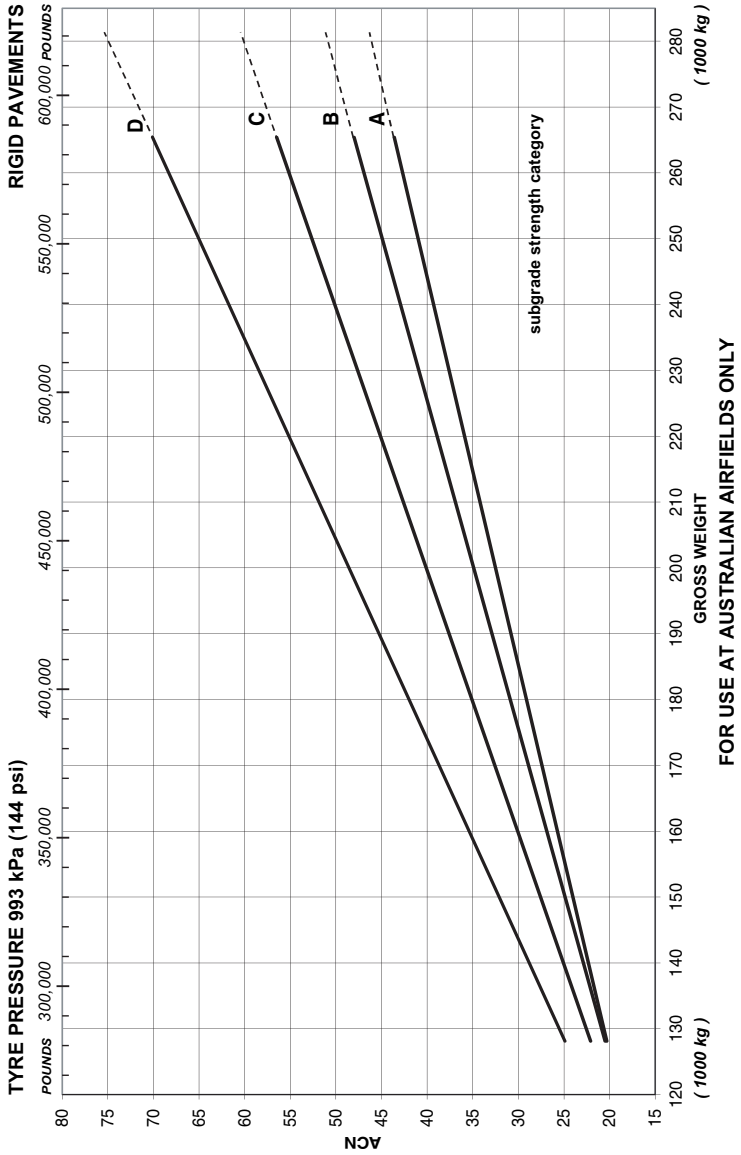

FOR USE AT AUSTRALIAN AIRFIELDS ONLY

8.4 C-27 J Spartan

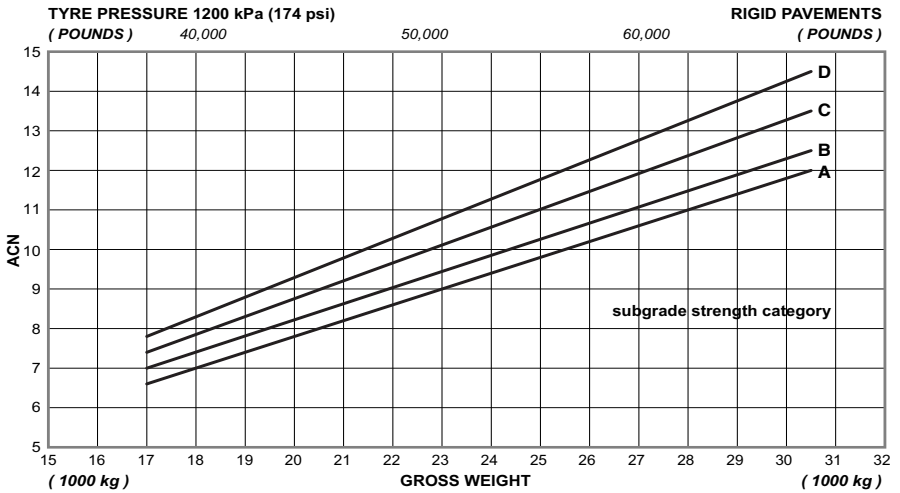
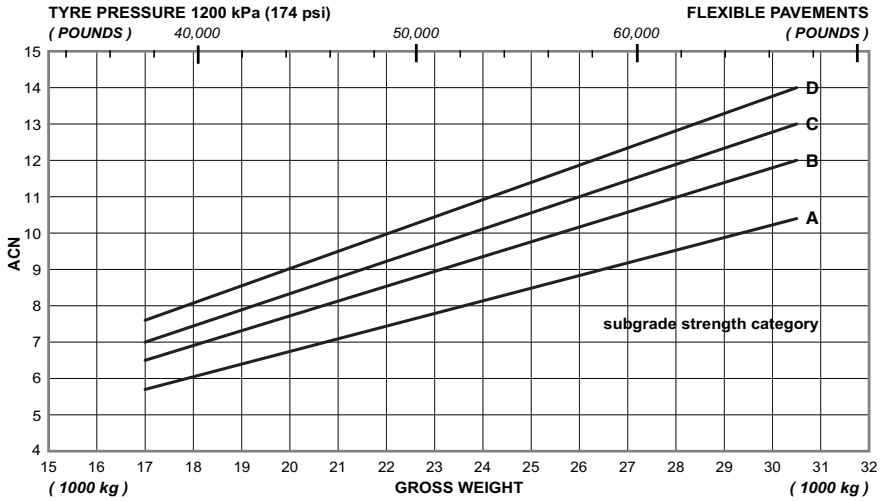

8.5 C130 J Hercules

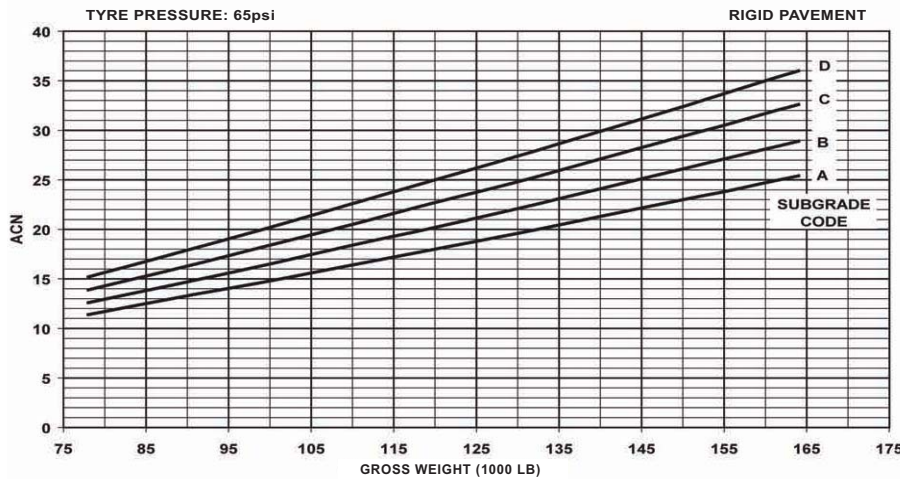
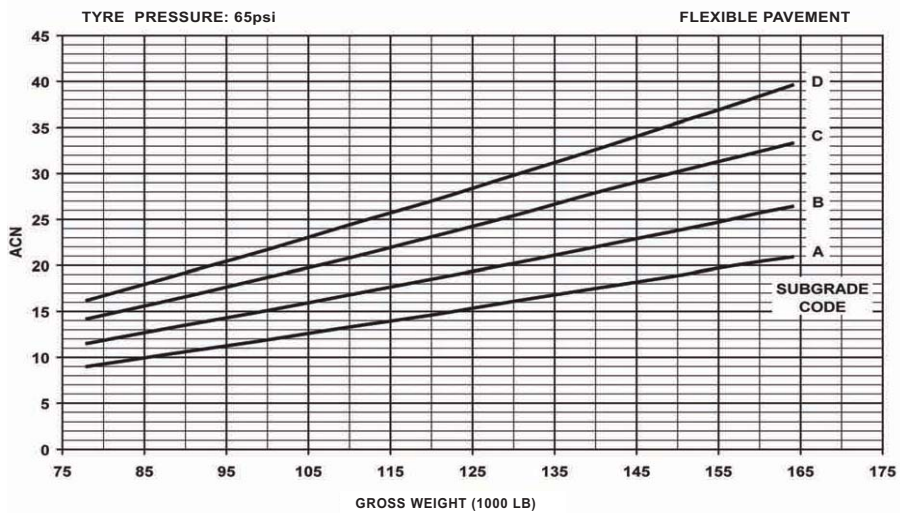

C130 J Hercules (cont.)

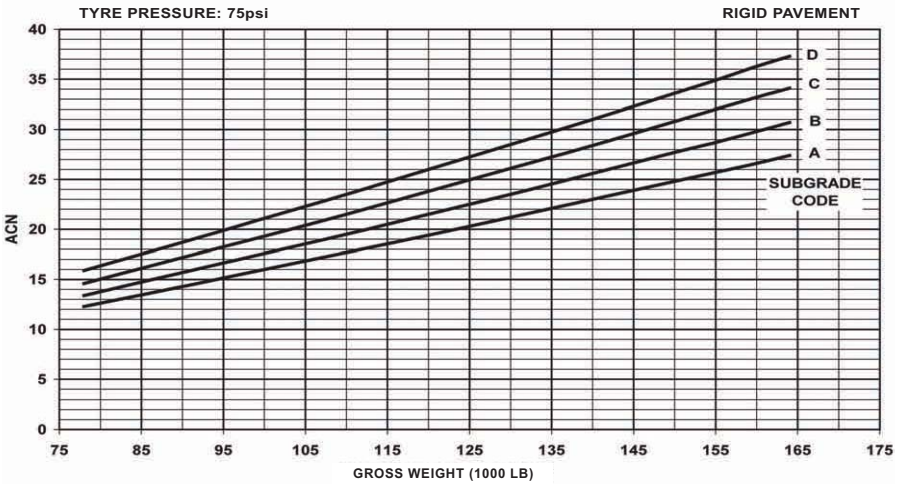
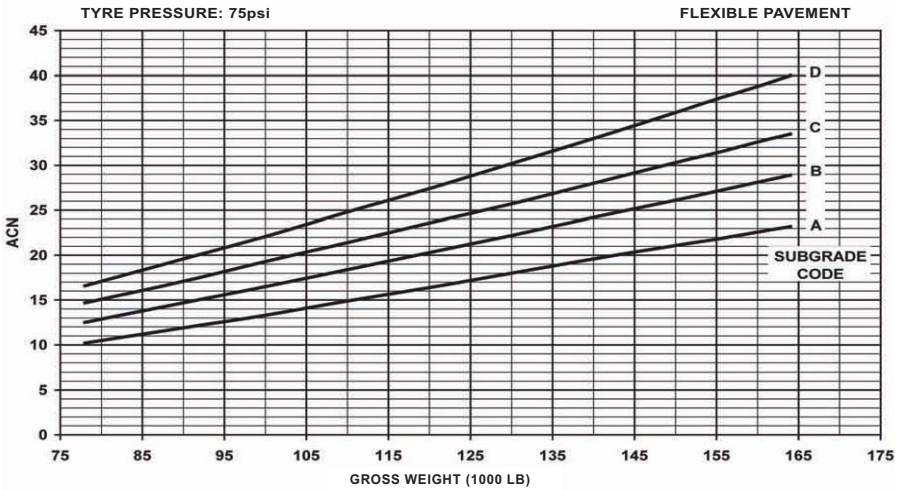

C130 J Hercules (cont.)

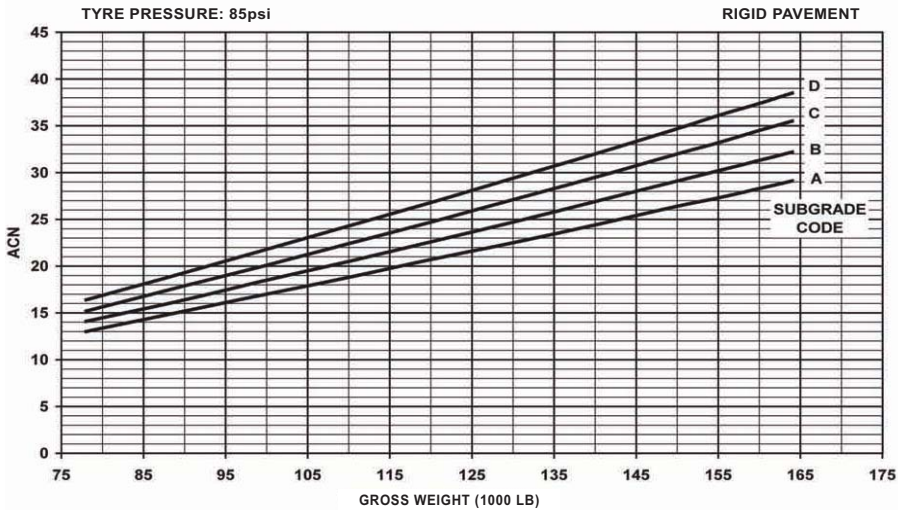
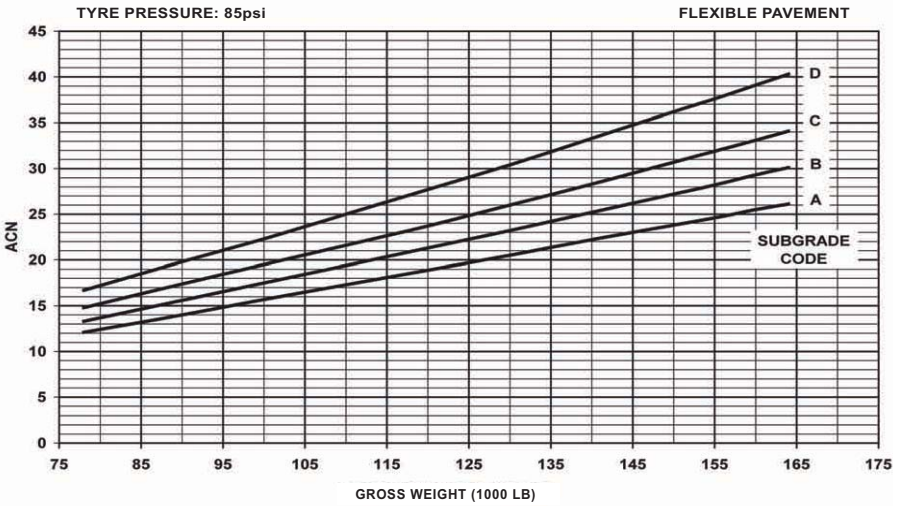



C130 J Hercules (cont.)

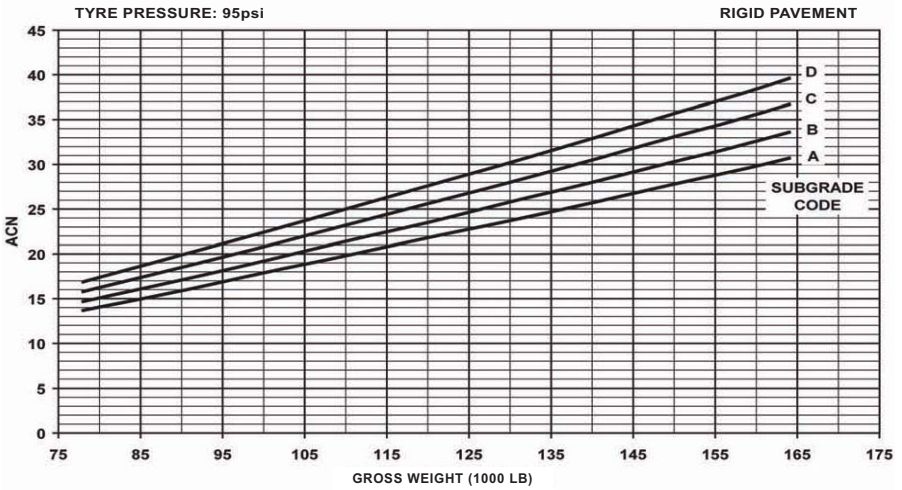
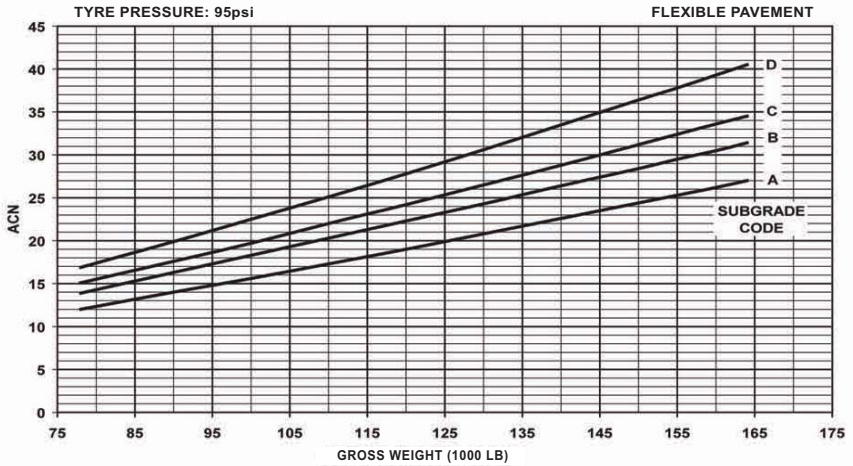

C130 J Hercules (cont.)

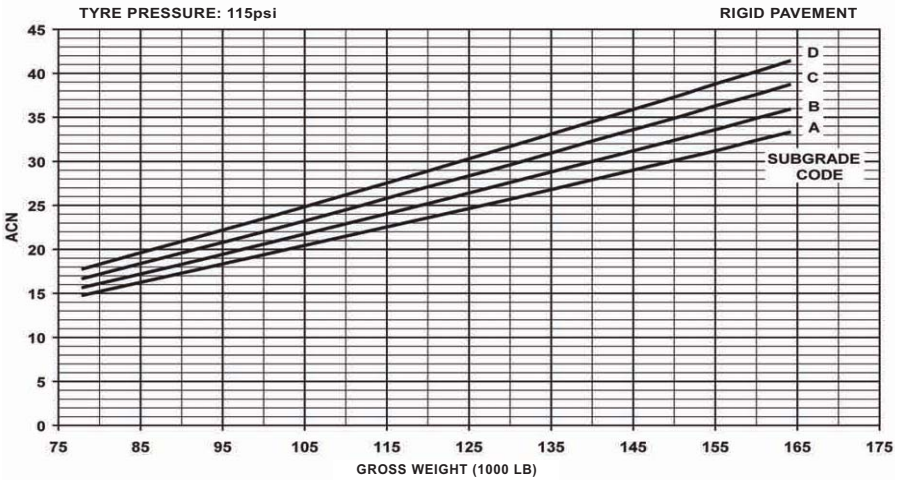
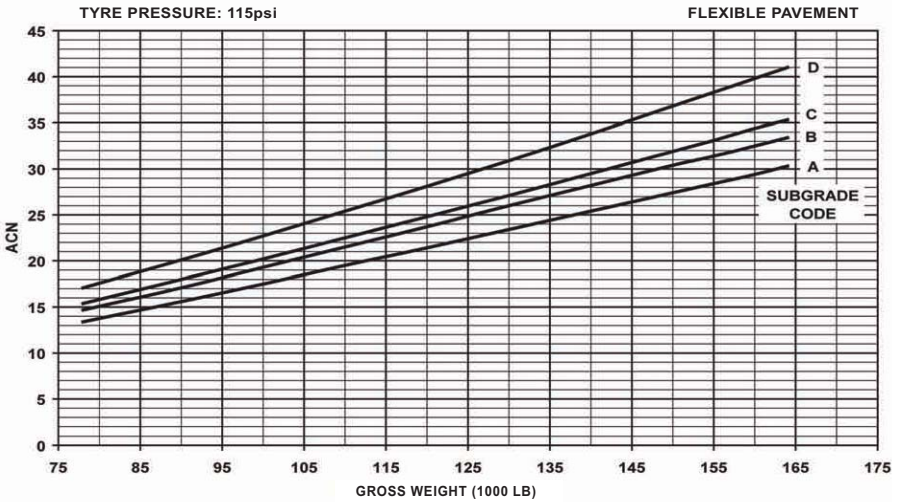

8.6 CH-47 F Chinook

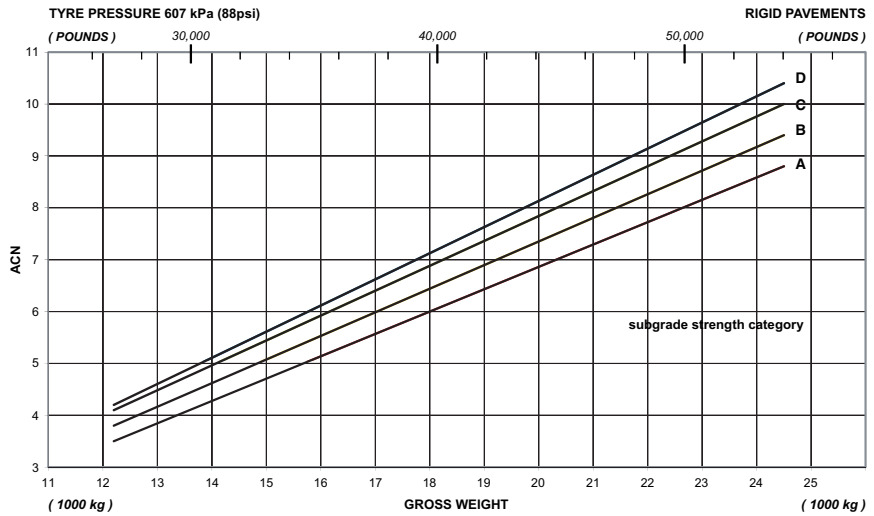
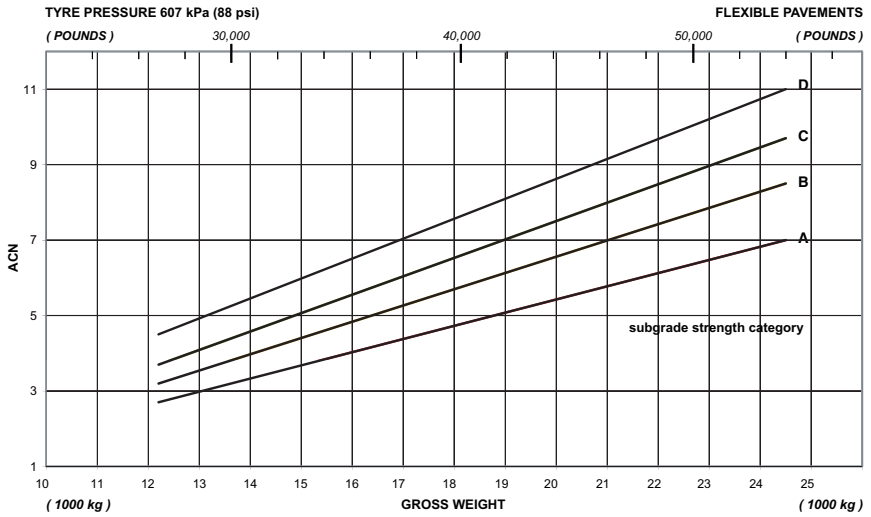

### 8.7 E-7A Wedgetail

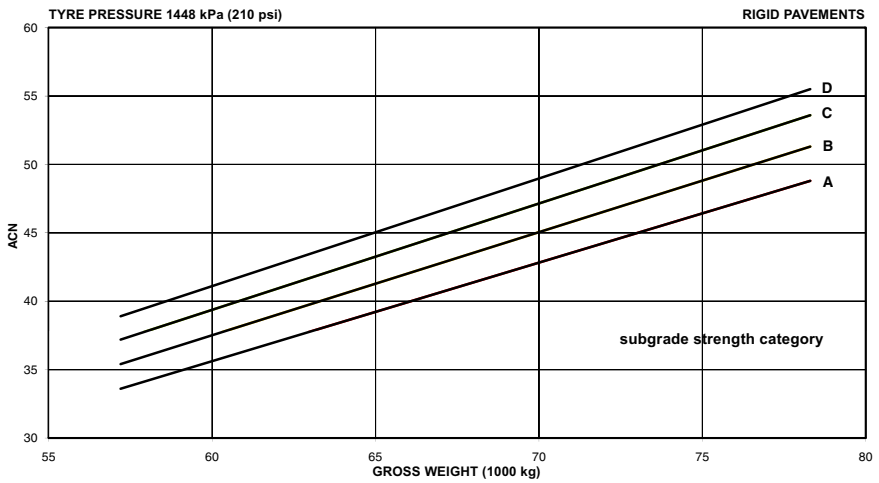
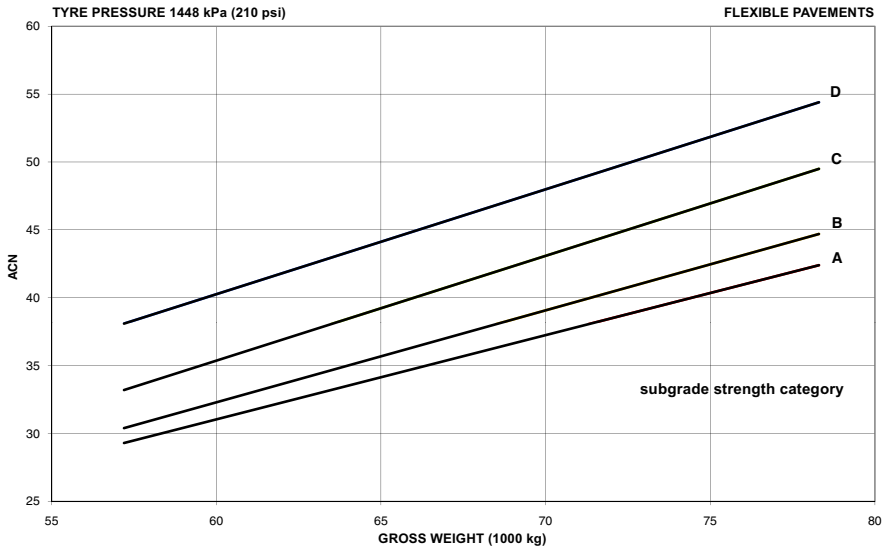

### 8.8 EC-665 Tiger Armed Reconnaissance Helicopter

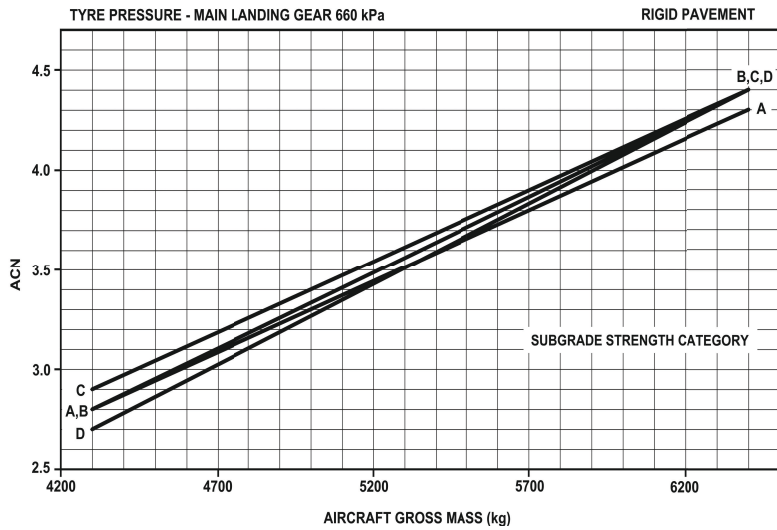
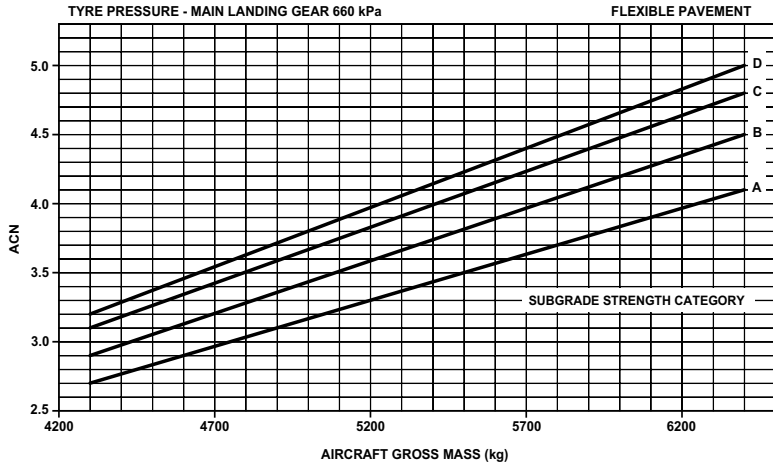

### 8.9 F/A-18A Hornet

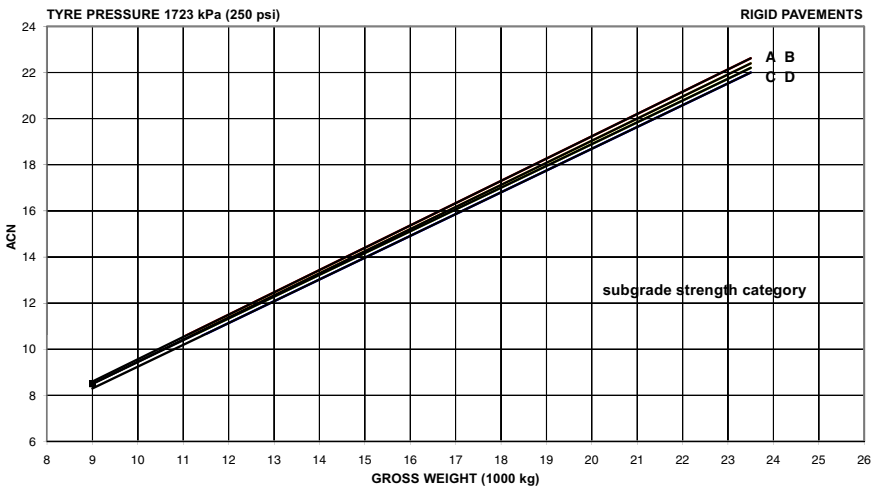
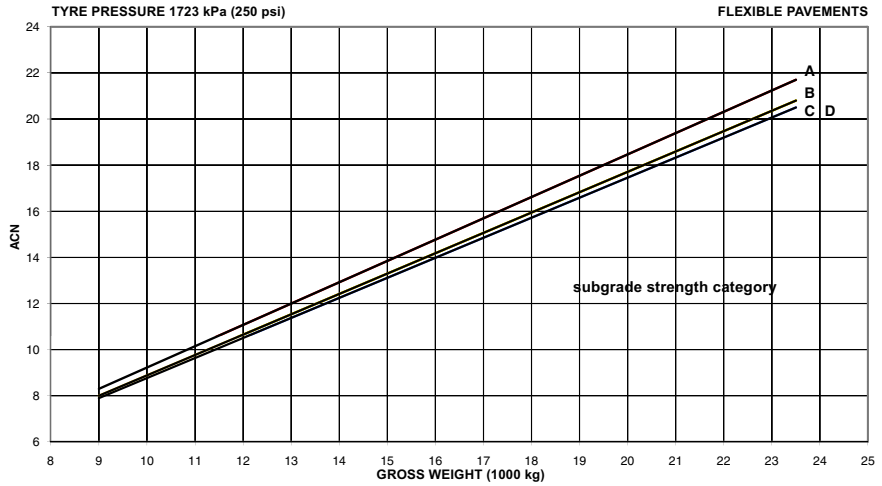

### 8.10 F/A-18F Super Hornet

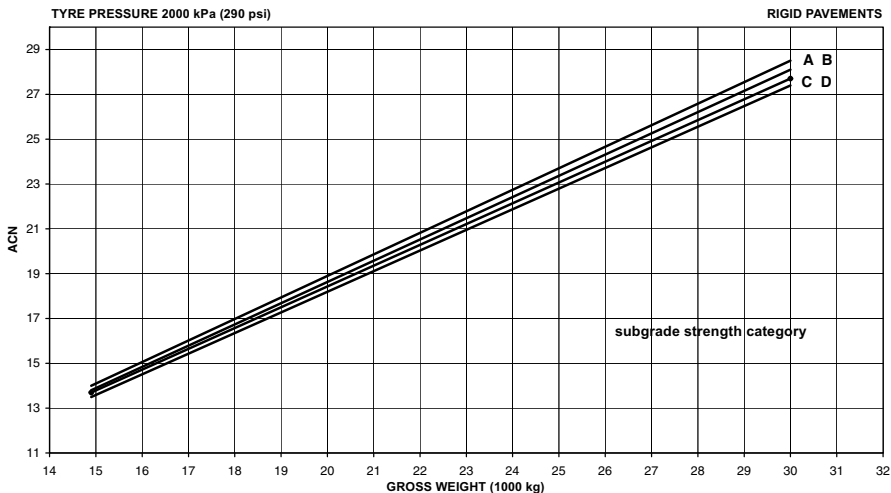
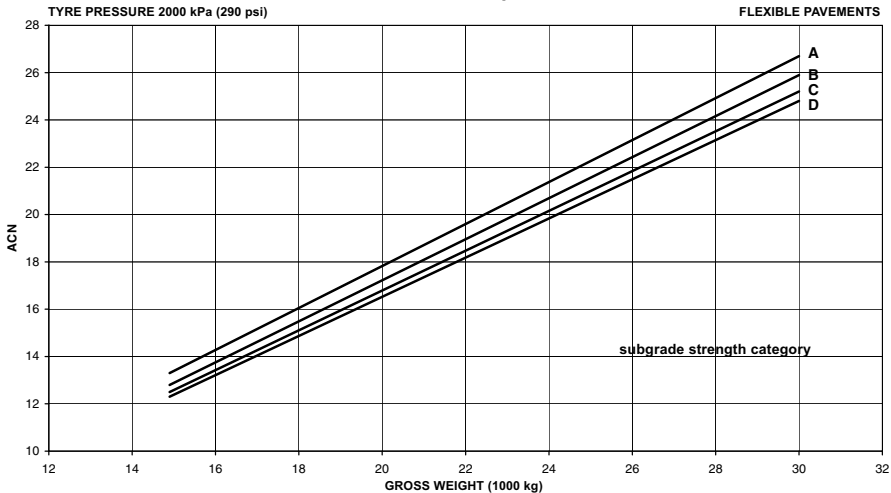

8.11 F-35A JSF

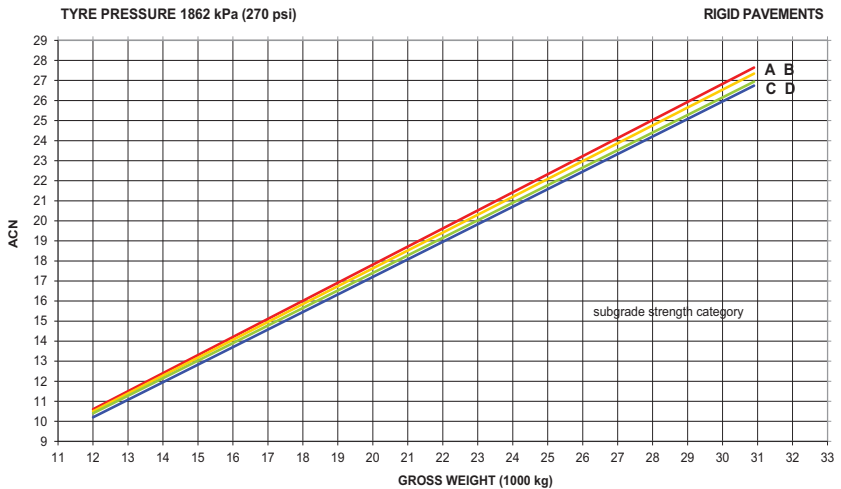
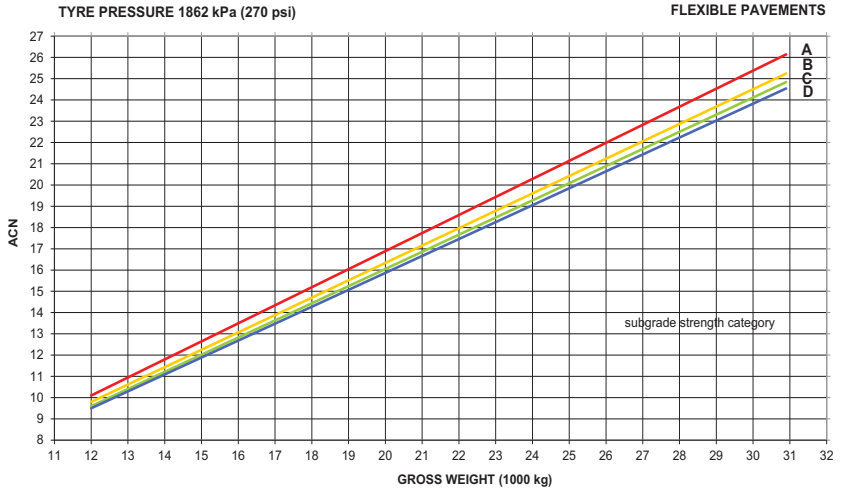



8.12 Falcon 7X

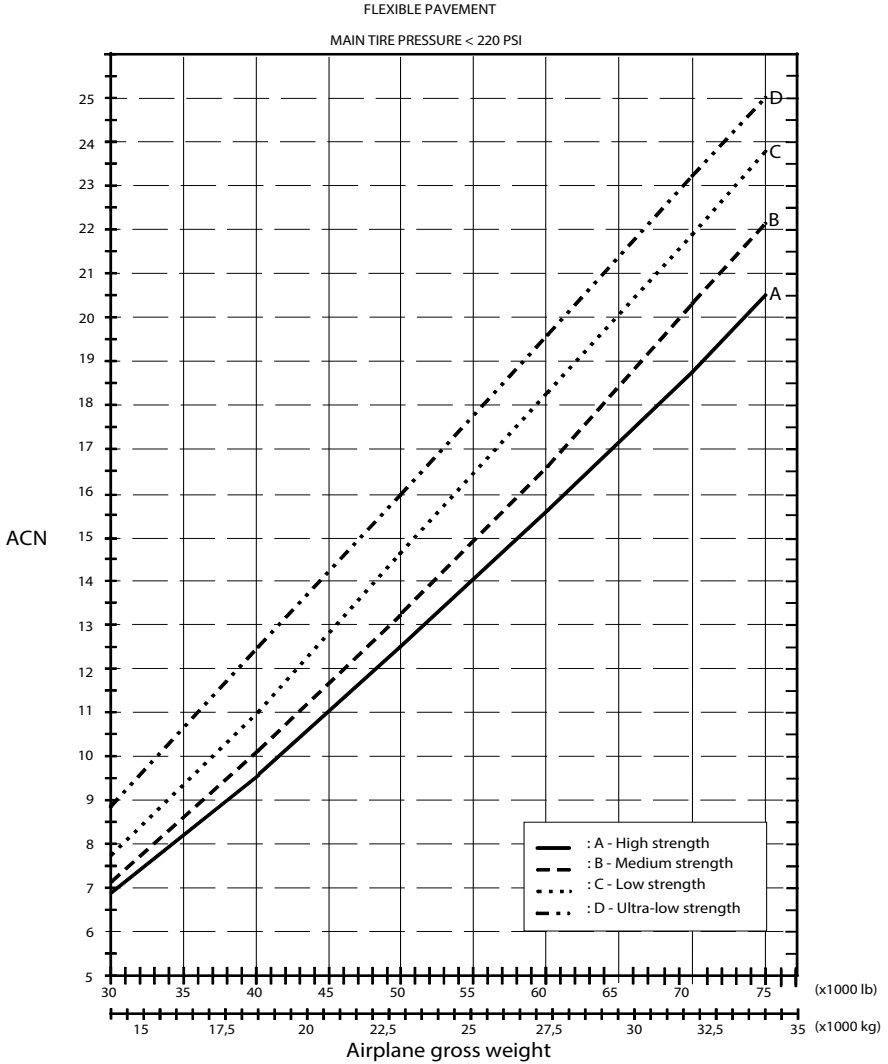

Falcon 7X

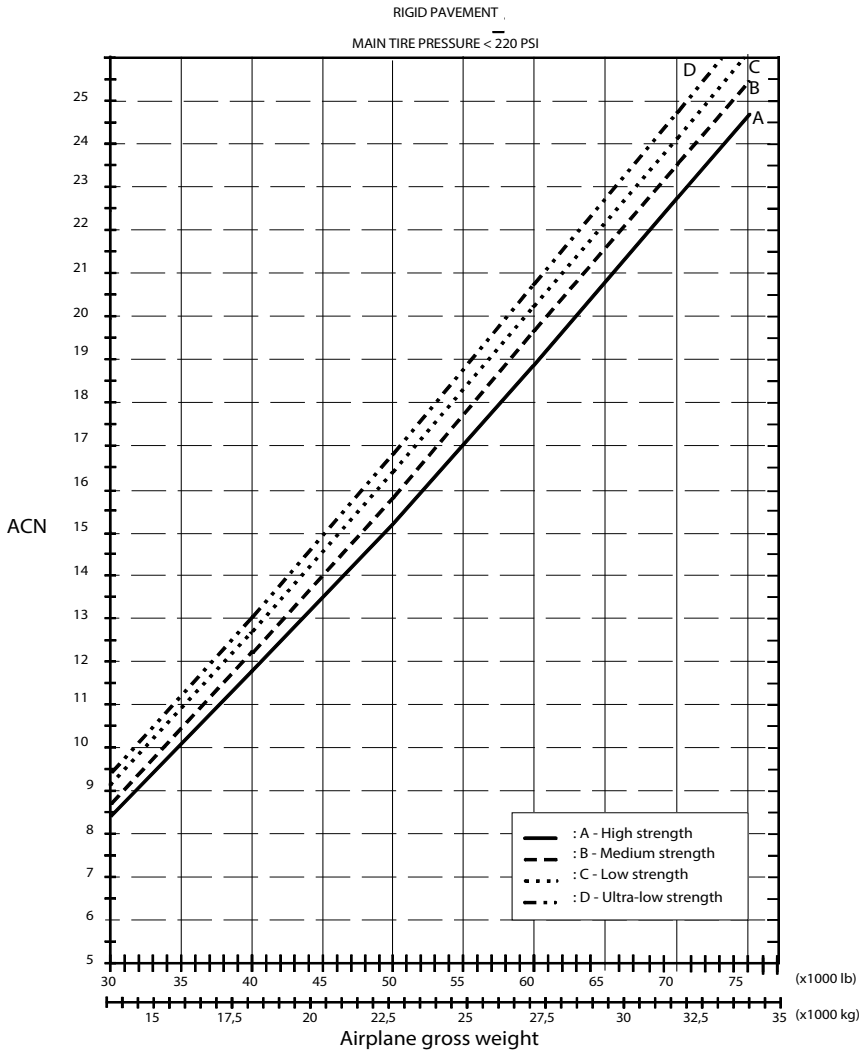

8.13 HAWK 127 Lead In Fighter

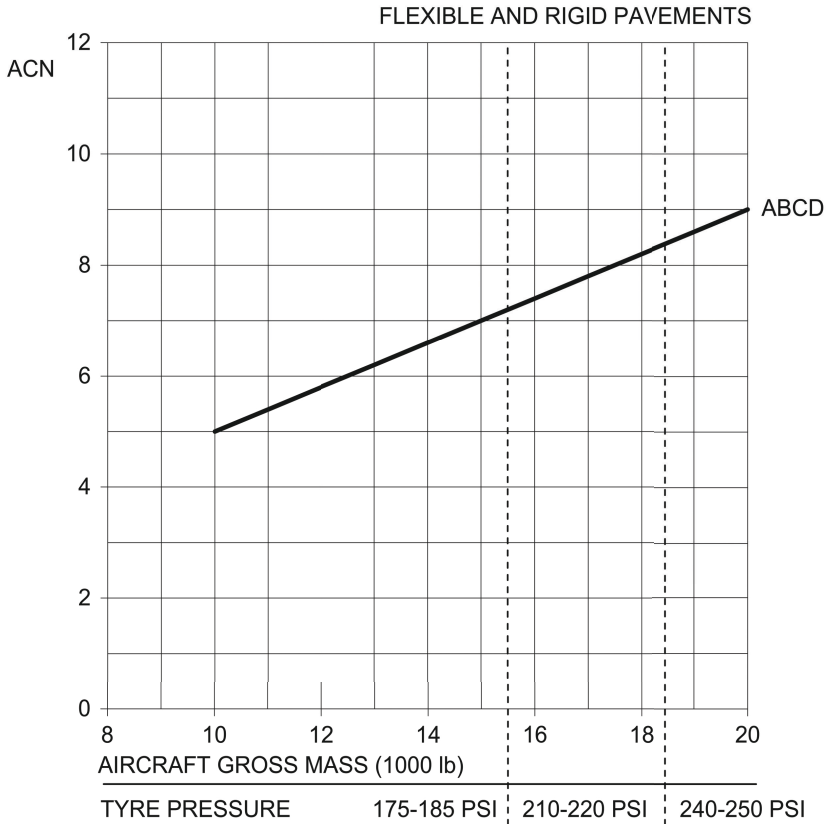

### 8.14 KC-30A MRTT

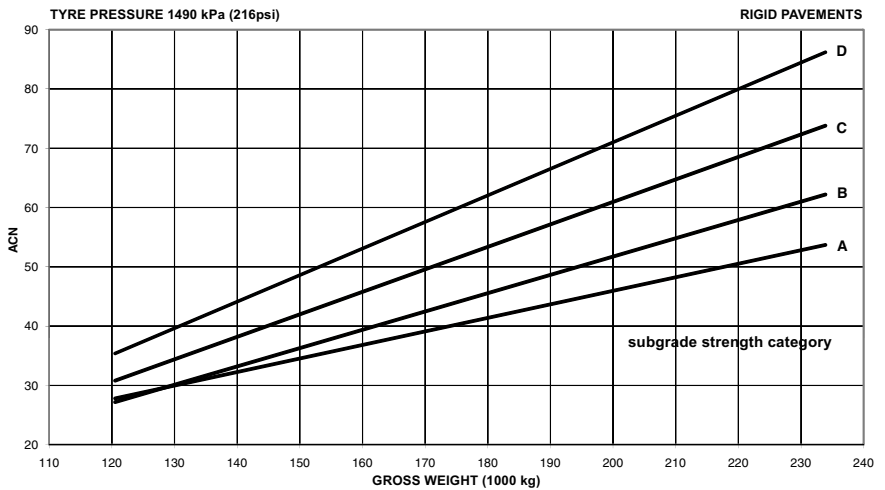
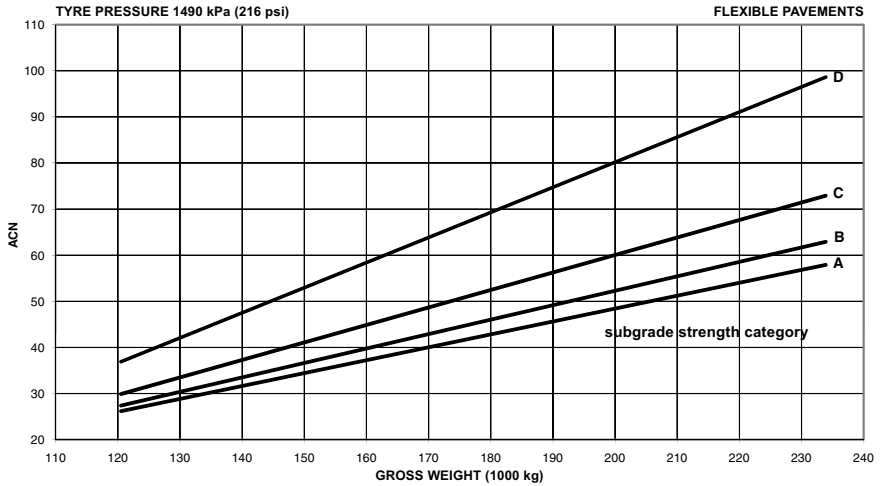

8.15 MH-60R SEAHAWK ROMEO

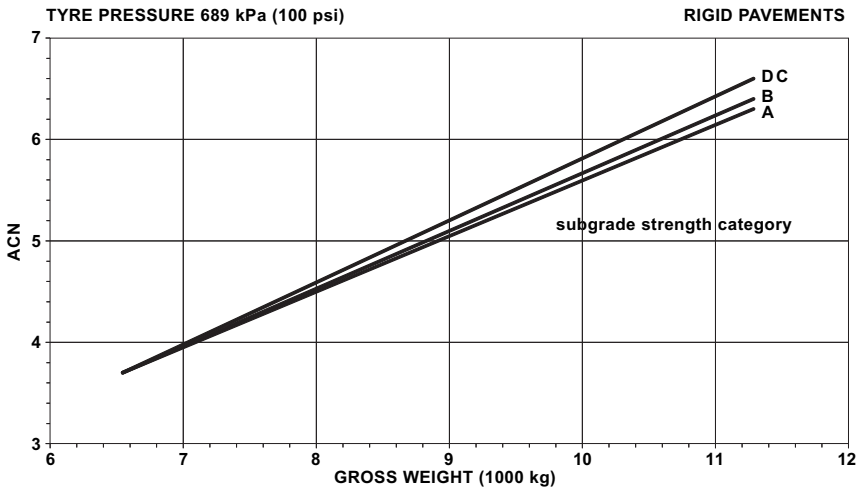
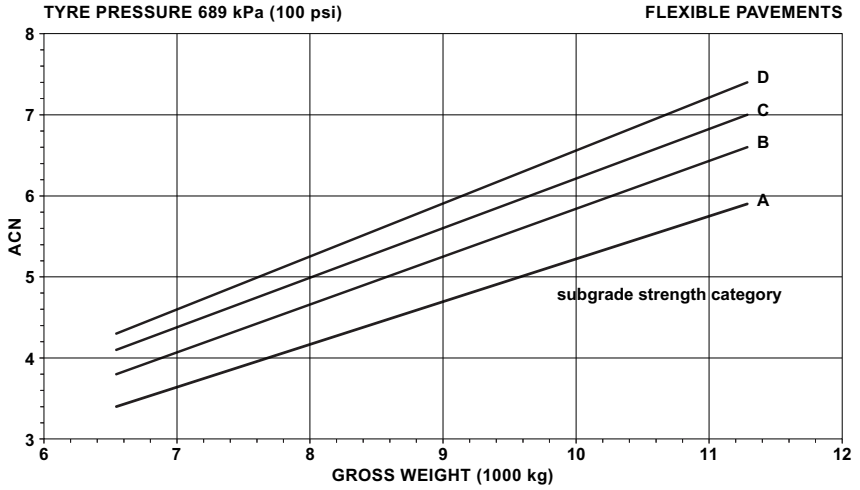

8.16 MRH90 HELICOPTER

TACTICAL TRANSPORT HELICOPTER (TTH) - NORMAL AND HIGH CABIN

FLEXIBLE AND RIGID PAVEMENTS

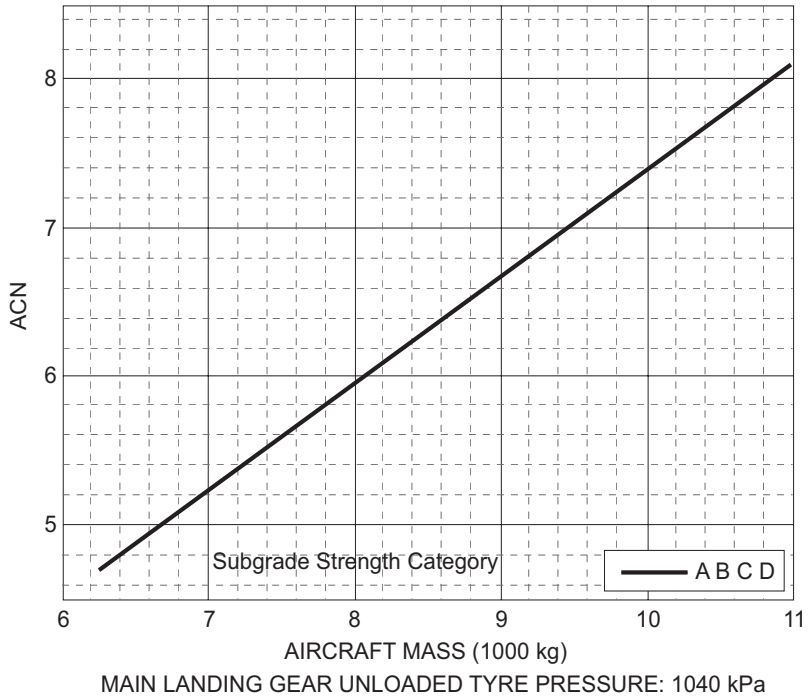

8.17 AP-3C Orion

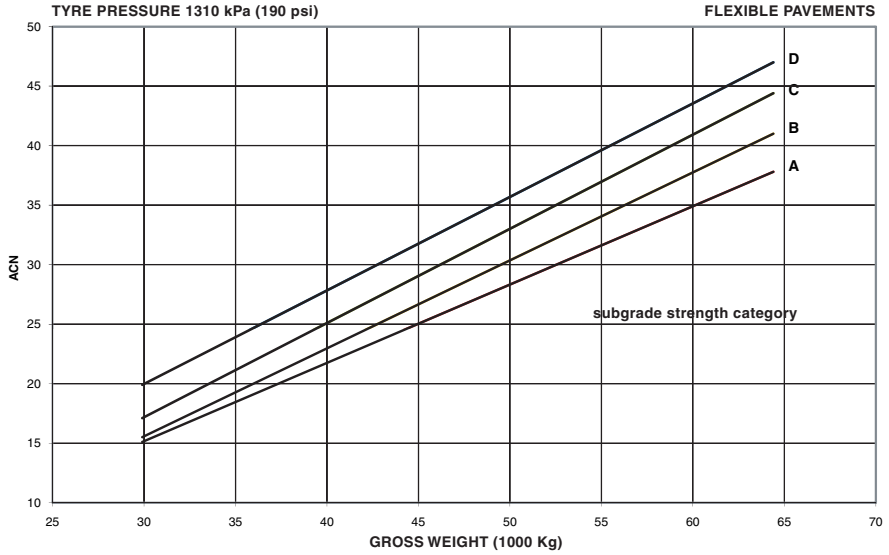

AP-3C Orion (cont.)

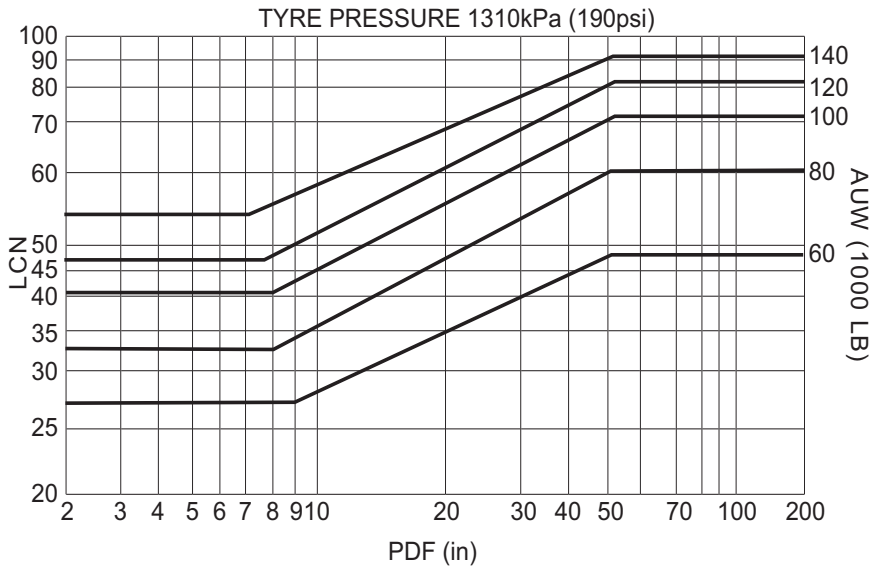
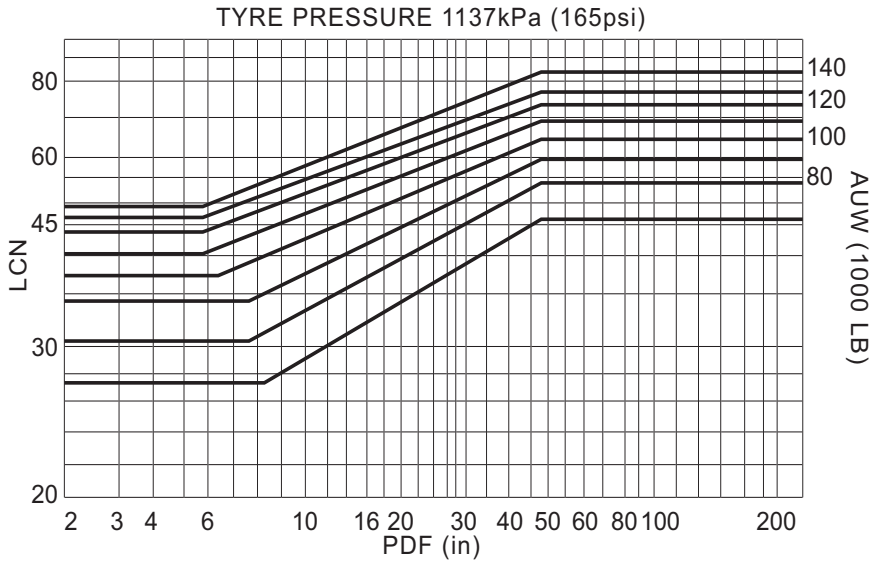



8.18 P-8 Poseidon

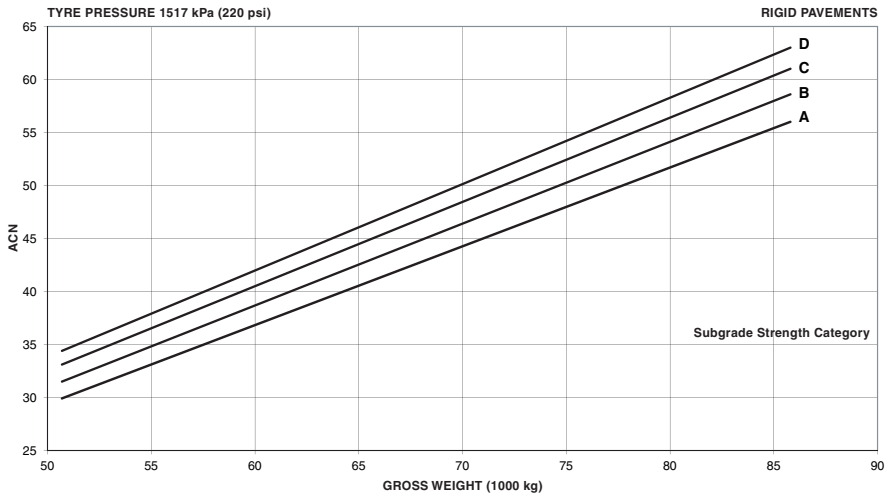
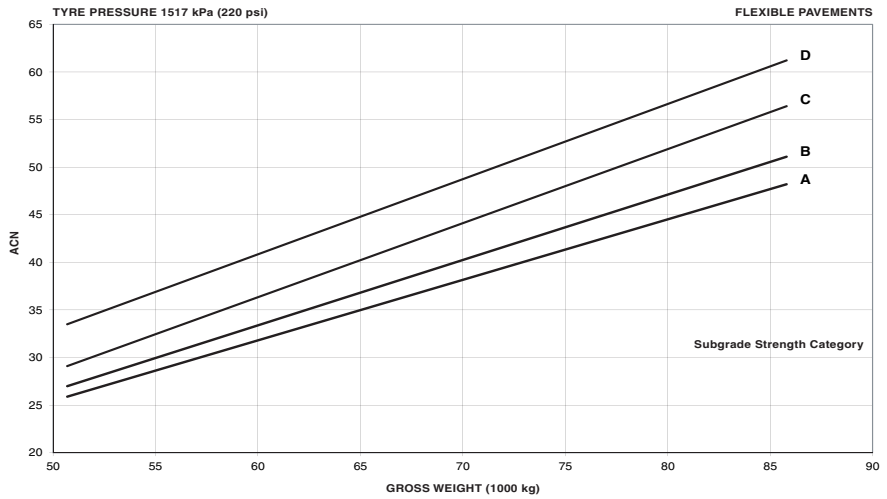

## AD 1.2 RESCUE AND FIRE FIGHTING SERVICES AND SNOW PLAN

### 1. RESCUE AND FIRE FIGHTING SERVICES

#### 1.1 General

1.1.1 Subpart 139.H (Aerodrome rescue and firefighting services) of *CASR 1998* and *Part 139H Manual of Standards*, which are available via the CASA website, prescribe the standards for RFFS in Australia. RFFS categories are based on the rescue and firefighting standards contained in *ICAO Annex 14, Vol I, Aerodrome Design and Operations, Chapter 9*.

1.1.2 RFFS is provided at certain aerodromes according to the type of aircraft normally using that aerodrome and the frequency of aircraft operations. Details of the RFFS available at Australian aerodromes, including hours of operation, can be found in the ERSA.

#### 1.2 Levels of Emergency Response at Aerodromes

1.2.1 This section summarises the levels of emergency response that are normally provided under an AEP.

##### 1.2.2 Local Standby

1.2.2.1 A Local Standby involves the activation of the airport-based responding agencies. Outside services do not normally respond for a Local Standby. At an aerodrome without RFFS facilities, the response (if any) to a declaration of a Local Standby will be set out in the AEP.

1.2.2.2 A Local Standby will be the normal response when an aircraft approaching an airport is known or is suspected to have developed some defect or operational issue, but the trouble is not such as would normally involve any serious difficulty making a safe landing.

1.2.2.3 Unless the pilot requests otherwise, at least a Local Standby will be initiated in response to a PAN call.

##### 1.2.3 Full Emergency

1.2.3.1 A Full Emergency involves the activation of both airport and off-airport responding agencies.

1.2.3.2 A Full Emergency will be the normal response when an aircraft approaching the airport is known or suspected to be in such trouble that there is danger of an accident.

1.2.3.3 Unless the pilot requests otherwise, a Full Emergency will be initiated in response to a MAYDAY call.

1.2.3.4 A crash on the airport will initiate a Full Emergency response.

##### 1.2.4 Aerodromes where no RFFS is Provided/in Operation

1.2.4.1 For an aerodrome where there is no on-airport fire service or when the airport fire service has been stood down, ATS will ask the pilot to advise services required on arrival. ATS will then activate the AEP at the appropriate level.

#### 1.3 RFFS Emergency Frequency

1.3.1 RFFS emergency frequency 131.0MHz is available for direct communication between the Fire Commander and affected flight crew during an airport emergency at selected airports (identified in ERSA FAC under Rescue and Firefighting Services). ATC must be advised of an intention to operate on the frequency.

1.3.2 All communication with ATC during an airport emergency must be conducted on the normal ATC frequencies.

**2. SNOW PLAN**

2.1 Only a small number of aerodromes and heliports within Australia are normally subject to snow conditions. Consequently there is no national snow plan, or any specific regulation for the clearance of snow and ice from runways and manoeuvring areas.

2.2 For aerodromes and heliports likely to be affected, pilots and operators are advised to contact the aerodrome operator directly for information about the relevant aerodrome snow plan.

**3. RUNWAY SURFACE CONDITION ASSESSMENT AND REPORTING**

3.1 This section covers the methodology for assessing and reporting runway surface conditions in accordance with the ICAO Global Reporting Format (GRF). Aeroplane operators should utilise the information in conjunction with the performance data provided by the aircraft manufacturer to determine if landing or take-off operations can be conducted safely, or if additional landing or take-off distances are required. Further information on the GRF as well as the assessment and reporting of runway surface conditions can be found in: [www.casa.gov.au/sites/default/files/2024-02/multi-part-advisory-circular-91-32-and-139-22-global-reporting-format-runway-surface-condition.pdf](http://www.casa.gov.au/sites/default/files/2024-02/multi-part-advisory-circular-91-32-and-139-22-global-reporting-format-runway-surface-condition.pdf).

**3.2 Assessment of Runway Surface Condition**

3.2.1 GRF is applicable at all certified aerodromes and only to sealed runways. Runway surface conditions are assessed and reported whenever water or contaminants are present on an operational runway. A Runway Condition Report (RCR) is disseminated when there are significant changes in the runway surface condition.

3.2.2 The RCR contains a Runway Condition Code (RWYCC) and information that describes the runway surface condition, i.e. type of surface contaminants, depth and coverage for each runway third.

3.2.3 The predominant runway surface conditions in Australia are due to water contamination of a runway i.e. 'wet' or 'slippery wet' runways or runways with 'standing water'. Guidance for winter runway surface conditions is provided in: [www.casa.gov.au/sites/default/files/2024-02/multi-part-advisory-circular-91-32-and-139-22-global-reporting-format-runway-surface-condition.pdf](http://www.casa.gov.au/sites/default/files/2024-02/multi-part-advisory-circular-91-32-and-139-22-global-reporting-format-runway-surface-condition.pdf).

3.2.4 The initial RWYCC is assigned based on the runway surface description:

Runway surface description	Applicable RWYCC
<b>DRY</b>	6
<b>WET</b> (The runway surface is covered by any visible dampness or water up to and including 3mm depth)	5
<b>WET</b> ("slippery wet" runway)	3
<b>STANDING WATER</b> (depth of more than 3mm)	2

3.2.5 The surface friction characteristics of a runway, or a portion of it, can become degraded due to rubber deposits (e.g. in the touchdown zone), surface polishing, poor drainage or other factors. The determination that a runway is 'slippery wet' stems from various methods used solely or in combination. These methods may include functional friction measurements or using a continuous friction measuring device which are available to the aerodrome operator. Other ways for the aerodrome operator to become aware that a runway is 'slippery wet' is by receiving two or more consecutive pilot reports or relayed reports from ATC of a reduced braking action for a 'wet' runway that is 'MEDIUM' instead of 'GOOD'. To alert pilots to the particular hazards associated with slippery wet runways, the surface description of 'SLIPPERY WET' is used instead of 'WET'.

3.2.6 After the initial assignment of a RWYCC, an aerodrome operator can downgrade a RWYCC based on 2 or more consecutive pilot reports of a braking action less than that allocated for the RWYCC. The pilot reports can be provided by ATC to the aerodrome operator or directly from the pilot. The correlation of RWYCC with braking action is as follows:

Pilot report of runway braking action	Description	RWYCC
Not applicable		6
GOOD	Braking deceleration is normal for the wheel braking effort applied AND directional control is normal	5
GOOD TO MEDIUM	Braking deceleration OR directional control is between good and medium	4
MEDIUM	Braking deceleration is noticeably reduced for the wheel braking effort applied OR directional control is noticeably reduced	3
MEDIUM TO POOR	Braking deceleration OR directional control is between medium and poor	2
POOR	Braking deceleration is significantly reduced for the wheel braking effort applied OR directional control is significantly reduced	1
LESS THAN POOR	Braking deceleration is minimal to non-existent for the wheel braking effort applied OR directional control is uncertain	0

### 3.3 Reporting of Runway Surface Condition

3.3.1 The RWYCC is reported for each third of the runway assessed. The RCR includes:

- a. Aerodrome location indicator
- b. Date and time of assessment
- c. Runway designator:
  - (1) at non-controlled aerodromes, the runway designator promulgated by NOTAM will be the lower runway designation number
  - (2) at controlled aerodromes, the runway in use as promulgated by ATIS
- d. RWYCC for each runway third. The direction for listing the runway thirds shall be in the direction as seen from the runway designation number
- e. Percentage coverage of each runway third for slippery wet runways
- f. Contaminant depth, if available
- g. Surface description for each runway third.

*Note 1: The runway designator is prefixed by 'RWY' to indicate to pilots that the RCR or NOTAM is critical to safety and to aid NOTAM filtering, where available.*

*Note 2: If 25% or less of a runway third has standing water or is otherwise contaminated it is to be assigned a RWYCC of 5 and a surface description of WET.*

*Note 3: NOTAM are not issued for WET (RWYCC = 5) or DRY (RWYCC = 6) runways.*

### 3.4 Pilot reports about braking action.

3.4.1 If the braking action experienced on a runway at a controlled aerodrome is not as good as that reported, pilots are required to submit an AIREP SPECIAL. If the braking action experienced on a runway at a non-controlled aerodrome is different to that reported, pilots should inform ATC directly or submit an AIREP SPECIAL. Pilots may also be asked by the ATC to report their assessment of the braking action. Pilot reports directly to ATC should use the terms listed in *para* 3.2.6 or the AIREP template in *ENR 1.1 APPENDIX 1*. At non-controlled certified aerodromes and controlled aerodromes where ATC is not present (i.e. not a 24/7 tower) pilots are required to report braking action, not as good as that reported, directly to the aerodrome operator. Contact details for aerodrome operators are in *AIP-ERSA*.

### 3.5 Communicating RCR

#### 3.5.1 ATIS

3.5.1.1 ATIS is the primary means for communicating runway surface conditions at controlled aerodromes. The RCR will describe conditions for each runway third in the direction of landing/take-off.

#### 3.5.2 Air-ground voice communications

3.5.2.1 ATC will only provide RCR information through voice communications to inform about changes to the information provided via ATIS, or when specifically requested by a pilot. Normally, only the change in RWYCC or surface description will be communicated.

#### 3.5.3 NOTAM

3.5.3.1 Australia does not issue SNOWTAM. Instead, a NOTAM similar in content to a SNOWTAM may be issued for a runway that is contaminated and expected to remain that way for some time. The RCR content will be in Item E) of the NOTAM.

#### 3.5.4 FIS

3.5.4.1 When a RCR NOTAM is issued for a non-controlled aerodrome, or when ATC is not present at a controlled aerodrome e.g. not a 24/7 tower, ATC (Area Controllers) will provide a Flight Information Service (FIS) and relay the NOTAM to affected pilots.

#### 3.5.5 UNICOM and CA/GRS

3.5.6 Where an aerodrome has an established UNICOM or CA/GRS which is operating during the period a RCR NOTAM is issued, it will be relayed to pilots on the appropriate frequency.

### 3.6 Surface condition assessments for unpaved runways

3.6.1 The GRF runway surface condition assessment and reporting format does not apply to unpaved runways and no RCR will be issued.

## AD 1.3 INDEX TO AERODROMES AND HELIPORTS

1. A complete list of codes for aerodromes and helicopter landing sites in Australia is available in *ERSA GEN*.

## AD 1.4 GROUPING OF AERODROMES/HELIPORTS

1. Australian aerodromes and heliports are not grouped.

## AD 1.5 STATUS OF CERTIFICATION OF AERODROMES

1. The status of certification of aerodromes is available at the following website:  
<https://www.casa.gov.au/search-centre/aerodromes>



**AD 2. AERODROMES**

1. Details of aerodromes in Australia and its territories are contained in *ERSA FAC*.

**AD 2.1 FIHA AD2 SUPPLEMENTS**

1. FIHA AD2 Supplements provide operational airspace, planning, flying, abnormal operations and ground procedures that are directly related to aircraft operations at an aerodrome and the associated airspace.
2. eFIHA AD2 Supplements are available via the AIS-AF FIHA AD2 Supplements webpage (<https://ais-af.airforce.gov.au/>).





**AD 3 HELIPORTS**

1. Details of domestic heliports in Australia and its territories are contained in *ERSA FAC*.



INDEX

**A**

ACN & LCN  
 AP-3C Orion ..... AD 1 - 73

ACN/PCN  
 Boeing 737 BBJ ..... AD 1 - 51  
 Boeing C-17A Globemaster (flexible) ..... AD 1 - 53  
 Boeing C-17A Globemaster (rigid) ..... AD 1 - 54  
 C130 J Hercules ..... AD 1 - 56  
 C-27 J Spartan ..... AD 1 - 55  
 CH-47 D/F Chinook ..... AD 1 - 61  
 E-7A Wedgetail ..... AD 1 - 62  
 EC-665 Tiger helicopter ..... AD 1 - 63  
 F/A-18A Hornet ..... AD 1 - 64  
 F/A-18F Super Hornet ..... AD 1 - 65  
 HAWK 127 Lead In Fighter ..... AD 1 - 69  
 KC-30B MRTT ..... AD 1 - 70  
 MH-60R Seahawk Romeo ..... AD 1 - 71  
 MRH90 helicopter ..... AD 1 - 72  
 P-8 Poseidon ..... AD 1 - 75

ADF  
 see also Army, Military, RAAF, RAN  
 aerobatic manoeuvres ..... ENR 1.1 - 1  
 aerodrome pavement strength evaluation ..... AD 1 - 45  
 aerodrome reference documents ..... AD 1 - 1  
 aircraft lighting ..... ENR 1.1 - 3  
 alternate waiver for training areas ..... ENR 1.1 - 51  
 altimeter settings in military CTA ..... ENR 1.7 - 3  
 arrestor barrier lighting ..... AD 1 - 27  
 arrestor system aiming light ..... AD 1 - 26  
 carriage of flight documentation ..... ENR 1.10 - 6  
 clearances below LSALT ..... ENR 1.1 - 8  
 cloud break procedure ..... ENR 1.6 - 6  
 conditions affecting alternate planning ..... ENR 1.1 - 50  
 CSIG PCN advice line ..... AD 1 - 41  
 DME/GPS arrival chart format ..... ENR 1.5 - 27  
 DTRM and HCM markers ..... AD 1 - 26  
 exemption from position reporting ..... ENR 1.1 - 13  
 flight notification requirements ..... ENR 1.10 - 3  
 flight plan submission requirements ..... ENR 1.10 - 4  
 flight planning IAW established traffic flow ..... ENR 1.1 - 24  
 formation flight level assignment ..... ENR 1.7 - 4  
 formation flights ..... ENR 1.1 - 65  
 formation landing procedure ..... ENR 1.1 - 17  
 formation take-off ..... ENR 1.1 - 8  
 formation taxiing aircraft separation ..... ENR 1.1 - 7  
 fuel dumping ..... ENR 1.1 - 57  
 fuel requirements ..... ENR 1.1 - 55  
 full stop landings at military aerodromes ..... ENR 1.1 - 18  
 general rules of the air ..... ENR 1.1 - 1  
 GNSS distance reports to ATS ..... ENR 1.1 - 30  
 GNSS positive fix ..... ENR 1.1 - 23  
 GNSS receiver for night under VFR ..... ENR 1.1 - 53  
 holding and IAL procedures ..... ENR 1.5 - 1  
 IFR alternate minima criteria ..... ENR 1.1 - 52  
 IFR alternate weather minima ..... ENR 1.5 - 21  
 IFR requirements ..... ENR 1.3 - 1  
 instrument rating restrictions ..... ENR 1.1 - 50

landing crosswind component ..... ENR 1.1 - 16

landing sequence at military aerodromes ..... ENR 1.1 - 17

lighting of runways ..... AD 1 - 26

MARSA ..... ENR 1.1 - 58

minimum safe heights ..... ENR 1.1 - 1

MSA reference point ..... ENR 1.5 - 12

notification of dangerous cargo to ATC ..... ENR 1.1 - 18

operational control ..... ENR 1.1 - 69

pavement concession ..... AD 1 - 41

pavement concessions for ADF airfields ..... AD 1 - 45

PCN technical advice ..... AD 1 - 41

pilot activated lighting ..... ENR 1.1 - 54

POB notification ..... ENR 1.1 - 39

procedure containment ..... ENR 1.5 - 17

RAAF balloon flight ..... ENR 5 - 50

recalling military aircraft due weather ..... ENR 1.1 - 69

Regular TAF service and IAL minima ..... ENR 1.5 - 21

RTCC (RADAR terrain clearance chart) ..... ENR 1.5 - 1

runway distance to go sign ..... AD 1 - 22

SARTIME/NOCOM procedures ..... ENR 1.10 - 7

separation in military CTA ..... ENR 1.4 - 6

separation in military training areas ..... ENR 1.4 - 7

site elevation for pre-flight altimeter check ..... ENR 1.7 - 1

special requirements flights ..... ENR 1.1 - 68

standard take-off minima ..... ENR 1.5 - 20

TACAN used for DME ..... ENR 1.5 - 27

taxi clearance for dangerous cargo ..... ENR 1.1 - 7

taxi clearance POB ..... ENR 1.1 - 7

touch-and-go notification ..... ENR 1.1 - 18

towing objects ..... ENR 1.1 - 3

unlit operations ..... ENR 1.1 - 63

validation of PCN ..... AD 1 - 41

aerial photography, liaison with ATC ..... ENR 1.1 - 57

aerodrome

    visual docking guidance systems ..... AD 1 - 37

aerodrome information signs

    destination sign ..... AD 1 - 21

    direction sign ..... AD 1 - 21

    distance to go sign ..... AD 1 - 22

    military aerodrome distance to go sign ..... AD 1 - 22

    runway exit ..... AD 1 - 21

    taxiway location sign ..... AD 1 - 21

aerodrome lighting, see lighting

aerodrome mandatory instruction signs

    aircraft no entry ..... AD 1 - 23

    runway intersection sign ..... AD 1 - 23

    taxi-holding position ..... AD 1 - 22

    taxi-holding position CAT I ILS runway ..... AD 1 - 22

    taxi-holding position CAT II ILS runway ..... AD 1 - 22

    taxi-holding position sign at other locations ..... AD 1 - 23

aerodrome markers and markings

    aiming point and touchdown zone ..... AD 1 - 11

    aircraft type limit designation ..... AD 1 - 20

    alignment line ..... AD 1 - 19

    apron edge markings ..... AD 1 - 18

    apron markings ..... AD 1 - 18, AD 1 - 20

    arrestor system hookcable markers ..... AD 1 - 15

    arrestor system warning marker ..... AD 1 - 16

    boundary markers ..... AD 1 - 5

    distance to run markers ..... AD 1 - 13

    holding bay markings ..... AD 1 - 18

keyhole marking ..... AD 1 - 19

LAHSO hold-short position markings ..... AD 1 - 12

lead-out line ..... AD 1 - 20

marshaller stop line ..... AD 1 - 18

military temporarily displaced threshold ..... AD 1 - 8

new taxiway holding position ..... AD 1 - 17

old taxiway holding and parking ..... AD 1 - 17

parking limit line ..... AD 1 - 20

parking position designation ..... AD 1 - 20

parking position markings ..... AD 1 - 18

parking position taxi guide-line ..... AD 1 - 18

parking weight limit designation ..... AD 1 - 20

pilot stop line ..... AD 1 - 18

primary position parking ..... AD 1 - 18

restricted operations marker ..... AD 1 - 7

runway centreline markings ..... AD 1 - 11

runway markings ..... AD 1 - 7

runway numbers ..... AD 1 - 12

runway side stripe and end ..... AD 1 - 10

runway strip markings ..... AD 1 - 12

runways used for taxiing ..... AD 1 - 12

sealed area beyond runway ..... AD 1 - 11

secondary parking position guide line ..... AD 1 - 19

secondary parking, alternative markings ..... AD 1 - 19

stopway markings ..... AD 1 - 12

taxi guide-line ..... AD 1 - 16

taxi guide-line designation ..... AD 1 - 20

taxiway pavement-strength limit ..... AD 1 - 17

taxiway-edge ..... AD 1 - 16

temporarily displaced threshold ..... AD 1 - 8

threshold markings ..... AD 1 - 7

triangle marking ..... AD 1 - 19

unserviceable areas ..... AD 1 - 6

aerodrome meteorological minima

    description ..... ENR 1.5 - 20

    pilot responsibilities ..... ENR 1.5 - 21

aerodrome operating minima

    considerations ..... ENR 1.5 - 10

aerodrome reference documents ..... AD 1 - 1

AEW&C

    definitions ..... ENR 1.1 - 76

    flight planning ..... ENR 1.1 - 78

    general procedures ..... ENR 1.1 - 76

air traffic incidents ..... ENR 1.14 - 1

airborne early warning and control, see AEW&C ..... ENR 1.1 - 76

aircraft

    operations without pavement concession ..... AD 1 - 49

aircraft classification number (ACN) ..... AD 1 - 41

aircraft pavement rating system

    RAAF evaluations ..... AD 1 - 45

aircraft pavement strength evaluation manual ..... AD 1 - 45

aircraft performance category

    definition ..... ENR 1.5 - 1

    helicopters ..... ENR 1.5 - 1

airships

    right of way ..... ENR 1.1 - 2

airspace

- ATC services and requirements ..... ENR 1.4 - 9
- Class A ..... ENR 1.4 - 1
- Class C ..... ENR 1.4 - 1
- Class D ..... ENR 1.4 - 1
- Class E ..... ENR 1.4 - 1
- mach number technique ..... ENR 2 - 1

air-to-air refuelling

- anchor operations ..... ENR 1.1 - 74
- anchor requirements ..... ENR 1.1 - 70
- ATC responsibilities ..... ENR 1.1 - 73
- flight planning ..... ENR 1.1 - 72
- phraseology ..... ENR 1.1 - 75
- receiver aircraft responsibilities ..... ENR 1.1 - 73
- tanker responsibilities ..... ENR 1.1 - 72
- track operations ..... ENR 1.1 - 73
- track requirements ..... ENR 1.1 - 70

all stations

- use in radio telephony ..... ENR 1.1 - 49

alternate

- Army destination lighting ..... ENR 1.1 - 53
- cloud amounts ..... ENR 1.1 - 51
- criteria for VHF aircraft ..... ENR 1.1 - 54
- due provisional forecast ..... ENR 1.1 - 50
- forecast improvement ..... ENR 1.1 - 51
- formation aircraft requirements ..... ENR 1.1 - 53
- fuel - thunderstorms or TURB ..... ENR 1.1 - 51
- fuel requirements ..... ENR 1.1 - 51
- fuel requirements validity ..... ENR 1.1 - 52
- helicopter operations ..... ENR 1.1 - 51
- IFR requirements ..... ENR 1.1 - 53
- lighting requirement exceptions ..... ENR 1.1 - 54
- nomination suitability ..... ENR 1.1 - 50
- operational requirement ..... ENR 1.1 - 52
- PAL at destination ..... ENR 1.1 - 53
- pilot responsibility ..... ENR 1.1 - 51
- portable lighting at destination ..... ENR 1.1 - 53
- RAN helicopter ..... ENR 1.1 - 50
- responsible person definition ..... ENR 1.1 - 54
- standby power at destination ..... ENR 1.1 - 53
- standby requirement ..... ENR 1.1 - 54
- VFR at night ..... ENR 1.1 - 53
- VFR helicopter minima ..... ENR 1.1 - 52
- VFR minima ..... ENR 1.1 - 52
- waived requirements ..... ENR 1.1 - 51

alternate aerodrome

- IFR minima ..... ENR 1.1 - 52, ENR 1.5 - 21
- special weather minima ..... ENR 1.5 - 22

alternate aerodromes

- instrument rating limitations ..... ENR 1.1 - 50

alternate requirements

- Army NVD ..... ENR 1.1 - 51

alternate standard pattern

- installation parameters ..... AD 1 - 23
- threshold lights ..... AD 1 - 23

- altimeter
  - error limits for IFR ..... ENR 1.7 - 1
  - error limits for VFR ..... ENR 1.7 - 1
  - IFR operational requirement ..... ENR 1.7 - 1
  - pre-flight accuracy check ..... ENR 1.7 - 1
  - unserviceable placard IFR ..... ENR 1.7 - 1
  - unserviceable placard VFR ..... ENR 1.7 - 1
  - VFR operations above FL200 ..... ENR 1.7 - 1
- altitude
  - DME/GPS arrival minima ..... ENR 1.5 - 27
- AP-3C Orion
  - operations in AEEZ ..... ENR 1.1 - 64
- approach
  - multi-stage lights ..... AD 1 - 31
- approach fix ..... ENR 1.5 - 14
- approach lighting
  - CAT II ..... AD 1 - 31
  - diagram ..... AD 1 - 29
- approach procedures
  - containment ..... ENR 1.5 - 17
  - DME arcs ..... ENR 1.5 - 16
  - missed approach ..... ENR 1.5 - 15
  - MSA ..... ENR 1.5 - 12
  - procedure entry ..... ENR 1.5 - 13
  - reversal procedures ..... ENR 1.5 - 15
  - segment parameters ..... ENR 1.5 - 14
  - straight-in approach ..... ENR 1.1 - 45
  - tolerances ..... ENR 1.5 - 17
- approach segment ..... ENR 1.5 - 14
- approach slope guidance
  - T-VASIS ..... AD 1 - 33
- apron
  - apron markings ..... AD 1 - 18
  - exit lights ..... AD 1 - 27
  - keyhole marking diagram ..... AD 1 - 19
  - lights ..... AD 1 - 28
  - markings ..... AD 1 - 20
  - marshaller stop line marking ..... AD 1 - 18
  - parking position guide line ..... AD 1 - 18
  - parking position markings diagram ..... AD 1 - 19
  - pavement strength markings ..... AD 1 - 18
  - pilot stop line marking ..... AD 1 - 18
- APV
  - runway alignment ..... ENR 1.5 - 3
  - visual manoeuvring in circuit ..... ENR 1.5 - 3
- area navigation
  - holding pattern limitation ..... ENR 1.5 - 17
  - off route tracking approval ..... ENR 1.1 - 24
  - publication details ..... ENR 3 - 1
  - tracking errors ..... ENR 1.1 - 23
- area QNH
  - accuracy ..... ENR 1.7 - 3
  - definition ..... ENR 1.7 - 2
  - NOCOM requirement ..... ENR 1.7 - 3

Army  
 see also ADF, Military  
 aircraft lighting ..... ENR 1.1 - 4  
 alternate for nav aids at night ..... ENR 1.1 - 53  
 alternate requirements ..... ENR 1.1 - 51  
 alternate requirements day VFR ..... ENR 1.1 - 51  
 alternate requirements for destination lighting ..... ENR 1.1 - 53  
 flight plan submission requirements ..... ENR 1.10 - 4  
 helicopter external load operations ..... ENR 1.1 - 3  
 instrument rating restrictions ..... ENR 1.1 - 50  
 minimum aerodrome lighting requirements ..... ENR 1.1 - 55

arriving aircraft  
 NAPS flight path ..... ENR 1.5 - 25  
 vector uses ..... ENR 1.6 - 1

ATC  
 flight priority assessment ..... ENR 1.4 - 11  
 MARSAs responsibility ..... ENR 1.1 - 58  
 meteorological assessment for pilots ..... ENR 1.5 - 21  
 runway selection due NAPS ..... ENR 1.5 - 25  
 take-off and landing minima assessment ..... ENR 1.5 - 21

ATC approval  
 RNAV tracking ..... ENR 1.1 - 24

ATC responsibility  
 unidentified aircraft in CTA ..... ENR 1.6 - 3  
 unlawful interference ..... ENR 1.6 - 4

ATIS  
 advice of LAHSO ..... ENR 1.1 - 33  
 TAF QNH implications ..... ENR 1.5 - 21

ATS  
 acknowledgment SARWATCH cancelled ..... ENR 1.1 - 49  
 Class E airspace ..... ENR 1.1 - 21

ATS responsibility  
 unlawful interference ..... ENR 1.13 - 1

ATS surveillance service  
 service failure ..... ENR 1.6 - 4  
 speed control termination ..... ENR 1.6 - 3

AT-VASIS ..... AD 1 - 33

Australian domestic flight notification (ADF) ..... ENR 1.10 - 8  
 Australian economic exclusion zone (AEEZ) ..... ENR 1.1 - 64

avoiding action  
 ATC responsibility CTA ..... ENR 1.6 - 3

**B**

balloon operations ..... ENR 5 - 50  
 at night ..... ENR 5 - 50  
 communication requirements ..... ENR 5 - 50  
 controlled airspace ..... ENR 5 - 51  
 in vicinity of aerodrome ..... ENR 5 - 50  
 MET conditions ..... ENR 5 - 50  
 right of way ..... ENR 1.1 - 2

bank angle ..... ENR 1.5 - 11  
 holding procedures ..... ENR 1.5 - 17

base turn  
 reversal procedure ..... ENR 1.5 - 15

bird hazard publication details ..... ENR 5 - 51  
 bird migration notification ..... ENR 5 - 51



block levels

- aircraft action on amendment or cancellation ..... ENR 1.7 - 4
- amendment or cancellation ..... ENR 1.7 - 4
- change of level within ..... ENR 1.7 - 4
- CTA ..... ENR 1.7 - 4
- IFR ..... ENR 1.7 - 4
- mach number technique separation ..... ENR 1.7 - 4

broadcast

- LJR progress ..... ENR 1.1 - 65

broadcast area

- dimensions ..... ENR 1.4 - 9

**C**

call-sign

- police operations ..... ENR 1.1 - 57

cancellation of SARWATCH ..... ENR 1.1 - 48

captain's responsibility

- approach procedure containment ..... ENR 1.5 - 17
- fuel dumping ..... ENR 1.1 - 57
- NAPS ..... ENR 1.5 - 25
- VFR ..... ENR 1.1 - 24

CASA

- manual of standards part 139 - aerodromes ..... AD 1 - 1

category

- aircraft performance ..... ENR 1.5 - 1

centreline

- runway lights ..... AD 1 - 26

certified aerodrome

- gliding operations ..... ENR 5 - 48

change of level

- pilot responsibility ..... ENR 1.7 - 4
- reach by specific parameters ..... ENR 1.7 - 4
- report ..... ENR 1.7 - 4

charts

- DME/GPS arrival format ..... ENR 1.5 - 27

circling

- concept explanation ..... ENR 1.5 - 2
- descent below MDA ..... ENR 1.5 - 2
- DME/GPS arrival restrictions ..... ENR 1.5 - 27
- missed approach procedure ..... ENR 1.5 - 6

circling area

- calculation ..... ENR 1.5 - 3
- no circling sectors ..... ENR 1.5 - 2
- restrictions ..... ENR 1.5 - 2

circuit

- departing the circuit area ..... ENR 1.1 - 41
- downwind report ..... ENR 1.1 - 16
- helicopter procedure controlled AD ..... ENR 1.1 - 61
- helicopter procedures non-controlled AD ..... ENR 1.1 - 61
- information ..... ENR 1.1 - 39
- initial and pitch procedure ..... ENR 1.1 - 47
- joining instructions controlled AD ..... ENR 1.1 - 15
- non standard operations ..... ENR 1.1 - 20
- parallel runway operations ..... ENR 1.1 - 20
- sequencing aircraft ..... ENR 1.1 - 19

circuit direction

- gliding operations ..... ENR 5 - 49
- non-controlled aerodrome ..... ENR 1.1 - 39
- safe aircraft operation ..... ENR 1.1 - 16

circuit directions ..... ENR 1.1 - 7

circuit height  
 specific requirements ..... ENR 1.1 - 40

civil CTR  
 definition ..... ENR 1.4 - 4  
 hours of operation ..... ENR 1.4 - 4

Class A airspace  
 area of application ..... ENR 1.4 - 1  
 parachute operations ..... ENR 5 - 49

Class C airspace  
 area of application ..... ENR 1.4 - 1  
 parachute operations ..... ENR 5 - 49

Class D airspace  
 area of application ..... ENR 1.4 - 1  
 departure report ..... ENR 1.1 - 10  
 parachute operations ..... ENR 5 - 49  
 parallel runway ops ..... ENR 1.1 - 20  
 VFR climb/descent by IFR ..... ENR 1.1 - 10  
 VFR departure by IFR flight ..... ENR 1.1 - 9

Class E airspace  
 area of application ..... ENR 1.4 - 1  
 ATS ..... ENR 1.1 - 21  
 operations ..... ENR 1.1 - 21  
 parachute operations ..... ENR 5 - 49  
 separation ..... ENR 1.1 - 21  
 traffic information ..... ENR 1.1 - 21  
 VFR climb/descent by IFR ..... ENR 1.1 - 10  
 VFR operations ..... ENR 1.1 - 21  
 VFR-on-Top by IFR ..... ENR 1.1 - 11

Class G airspace  
 descent procedure to ..... ENR 1.1 - 42  
 services to IFR/VFR ..... ENR 1.4 - 8

clearance  
 authorisation scope ..... ENR 1.1 - 56  
 below LSALT with NVG ..... ENR 1.1 - 8  
 below LSALT without NVG ..... ENR 1.1 - 8  
 block levels ..... ENR 1.7 - 4  
 DME/GPS arrival ..... ENR 1.5 - 27  
 final approach ..... ENR 1.1 - 13  
 LAHSO ..... AD 1 - 28  
 landing ..... ENR 1.1 - 16  
 MARSAs format ..... ENR 1.1 - 58  
 military CTA ..... ENR 1.4 - 7  
 minimum fuel status ..... ENR 1.1 - 55  
 NAPS ..... ENR 1.5 - 25  
 pilot responsibility ..... ENR 1.1 - 56  
 transponder requirement ..... ENR 1.6 - 5

clearance limit  
 final approach ..... ENR 1.1 - 13  
 special requirements flight ..... ENR 1.1 - 69

clearance requirements  
 OCA ..... ENR 2 - 1

climb gradient  
 missed approach ..... ENR 1.5 - 6

communication failure  
 transponder code selection ..... ENR 1.6 - 4

contra-circuit procedures  
 gliding operations ..... ENR 5 - 49

control area  
 see also CTA

control zone  
 see CTR

controlled aerodrome  
 circuit procedures for helicopters ..... ENR 1.1 - 61

controlled airspace  
 ATC services ..... ENR 1.4 - 1  
 block levels ..... ENR 1.7 - 4  
 coverage ..... ENR 1.4 - 1  
 definition ..... ENR 1.4 - 1  
 descent procedure from ..... ENR 1.1 - 42  
 deviation from route or track ..... ENR 1.1 - 23  
 dimensions for Australia ..... ENR 1.4 - 1  
 DME/GPS arrival ..... ENR 1.5 - 27  
 IFR non-compliance level selection ..... ENR 1.7 - 3  
 level request not IAW tables ..... ENR 1.7 - 3  
 promulgation ..... ENR 1.4 - 1  
 separation ..... ENR 1.4 - 5  
 track divergence ..... ENR 1.1 - 22  
 transponder discrete code requirement ..... ENR 1.6 - 5

converging ..... ENR 1.1 - 2  
 taxiing ..... ENR 1.1 - 3

conversion graphs for TP/LCN/SIWL ..... AD 1 - 50

cruising levels  
 request for non conforming ..... ENR 1.7 - 3  
 table north of 80°S ..... ENR 1.7 - 5  
 table south of 80°S ..... ENR 1.7 - 6

CTA  
 definition ..... ENR 1.4 - 4  
 NOCOM requirements ..... ENR 1.1 - 13

CTAF  
 IFR frequency change ..... ENR 1.1 - 42  
 report to ATC when changing ..... ENR 1.1 - 41

CTR  
 definition ..... ENR 1.4 - 4

curfews ..... ENR 1.5 - 26

**D**

dangerous cargo ..... ENR 1.1 - 7, ENR 1.1 - 18

departing aircraft  
 frequency change instructions ..... ENR 1.1 - 10  
 heading after take-off ..... ENR 1.6 - 1  
 NAPS flight path ..... ENR 1.5 - 25

departure  
 SARTIME ..... ENR 1.1 - 49

departure instruction  
 visual departure ..... ENR 1.1 - 9

departure procedure  
 helicopter operations ..... ENR 1.1 - 60

departure report  
 CTAF ..... ENR 1.1 - 41  
 determine time ..... ENR 1.1 - 41  
 required information ..... ENR 1.1 - 41

departure track  
 limitations ..... ENR 1.1 - 10

descent  
 IAL ..... ENR 1.5 - 11  
 reversal procedure ..... ENR 1.5 - 11

descent and entry ..... ENR 1.1 - 13

descent gradient  
 after FAF ..... ENR 1.5 - 11  
 IAL ..... ENR 1.5 - 11

descent point  
 nomination ..... ENR 1.1 - 13

descent profile  
 DME/GPS arrival ..... ENR 1.5 - 27  
 speed variation ..... ENR 1.1 - 13  
 standard ..... ENR 1.1 - 13

destination aerodrome  
 PAL ..... ENR 1.1 - 53  
 portable lighting ..... ENR 1.1 - 53  
 standby power ..... ENR 1.1 - 53

deviation  
 from correct track ..... ENR 1.1 - 22

displaced threshold  
 due ORP ..... ENR 1.1 - 69  
 lighting ..... AD 1 - 24

distance information  
 database derived ..... ENR 1.1 - 31

Distress  
 emergency fuel status ..... ENR 1.1 - 55

diversion  
 to alternate aerodrome ..... ENR 1.1 - 49

DME arc entry  
 holding procedures ..... ENR 1.5 - 19

DME arcs ..... ENR 1.5 - 16

DME limit  
 holding procedures ..... ENR 1.5 - 19

DME/GPS arrival  
 altitude minima ..... ENR 1.5 - 27  
 altitude restrictions ..... ENR 1.5 - 27  
 approach ..... ENR 1.5 - 27  
 chart format ..... ENR 1.5 - 27  
 circling restrictions ..... ENR 1.5 - 27  
 clearance ..... ENR 1.5 - 27  
 containment within CTA ..... ENR 1.5 - 27  
 controlled airspace ..... ENR 1.5 - 27  
 descent IAW DME/GPS steps ..... ENR 1.5 - 27  
 descent profile ..... ENR 1.5 - 27  
 flight visibility minima ..... ENR 1.5 - 27  
 holding or orbiting ..... ENR 1.5 - 27  
 landing runway not aligned ..... ENR 1.5 - 27  
 use of TACAN ..... ENR 1.5 - 27

docking guidance system  
 safegate system ..... AD 1 - 39

dropping of objects ..... ENR 1.1 - 3

due regard  
 operations ..... ENR 1.1 - 58

dumb-bell marker ..... AD 1 - 7

**E**

ELVA minima  
 normal operations ..... ENR 1.1 - 50

emergency  
 emergency fuel status ..... ENR 1.1 - 55  
 light signals to vehicles and pedestrians ..... ENR 1.5 - 28

en route frequency change ..... ENR 1.1 - 12

en route holding positions publication details ..... ENR 3 - 1

ENR 5.1 ..... ENR 1.1 - 4

entry  
     holding pattern ..... ENR 1.5 - 18  
 environmental limitations on operations ..... ENR 1.1 - 57  
 established  
     definition ..... ENR 1.5 - 11  
 established on final  
     vector report ..... ENR 1.6 - 2  
 ETA  
     report ..... ENR 1.1 - 12  
 exit gates  
     helicopter operations ..... ENR 1.1 - 59  
 explosive weapons stores ..... ENR 1.1 - 7, ENR 1.1 - 18  
 eye-height over the threshold ..... AD 1 - 33

**F**

facsimile  
     flight notification confirmation ..... ENR 1.10 - 2  
 fighter scrambles ..... ENR 1.1 - 8  
 final approach  
     clearance ..... ENR 1.1 - 13  
     vector ..... ENR 1.6 - 1  
     vector procedure ..... ENR 1.6 - 2  
 final approach speed ..... ENR 1.5 - 9  
 FIR  
     publication details ..... ENR 2 - 1  
 first contact  
     POB advice ..... ENR 1.1 - 39  
 fixes  
     approach procedures ..... ENR 1.5 - 14  
 flight  
     VFR conditions ..... ENR 1.1 - 22, ENR 1.2 - 1  
 flight details  
     local instructions ..... ENR 1.10 - 4  
     required when FPL not required ..... ENR 1.10 - 4  
 flight information area (FIA)  
     ATS services ..... ENR 1.4 - 8  
     definition ..... ENR 1.4 - 8  
 flight level deviation  
     reporting ..... ENR 1.1 - 36  
 flight note  
     format ..... ENR 1.10 - 23  
 flight notification  
     abbreviated details ..... ENR 1.10 - 2  
     aerial photography and survey ..... ENR 1.1 - 57  
     aircraft type format ..... ENR 1.10 - 10  
     amendments to ATS ..... ENR 1.10 - 6  
     area type flight ..... ENR 1.1 - 24  
     block level entry ..... ENR 1.10 - 16  
     change of aircraft ident/REG ..... ENR 1.10 - 6  
     change of flight rules entry ..... ENR 1.10 - 16  
     change of speed/level entry ..... ENR 1.10 - 16  
     common name use ..... ENR 1.10 - 5  
     cruise climb entry ..... ENR 1.10 - 16  
     cruising speed format ..... ENR 1.10 - 14  
     description of ADFN form ..... ENR 1.10 - 4  
     DR substitute of GNSS ..... ENR 1.10 - 4  
     EOBT requirements ..... ENR 1.10 - 14  
     estimated elapsed time requirements ..... ENR 1.10 - 5

facsimile confirmation ..... ENR 1.10 - 2

flight rules ..... ENR 1.3 - 1

form availability ..... ENR 1.10 - 4

IFR requirements ..... ENR 1.10 - 2

late submission ..... ENR 1.10 - 3

LJR bounce aircraft ..... ENR 1.1 - 65

LJR format ..... ENR 1.1 - 65

LJR operating levels ..... ENR 1.1 - 65

location code usage ..... ENR 1.10 - 5

locations/waypoints format ..... ENR 1.10 - 15

MARSA ..... ENR 1.1 - 58

methods of submission/distribution ..... ENR 1.11 - 1

military flights ..... ENR 1.10 - 3

military specific entries ..... ENR 1.10 - 22

NAV / COM equipment codes ..... ENR 1.10 - 11

NOCOM ..... ENR 1.10 - 7

non ATS route ..... ENR 1.10 - 5

PBN entries ..... ENR 1.10 - 4

PIFR and FPA ..... ENR 1.10 - 5

preferred method to submit ..... ENR 1.10 - 2

radio navigation systems ..... ENR 1.1 - 22

radio submission ..... ENR 1.10 - 2

requirements ..... ENR 1.10 - 2

route format ..... ENR 1.10 - 15

SARTIME nomination ..... ENR 1.1 - 49

SARTIME requirements ..... ENR 1.10 - 2

SARWATCH ..... ENR 1.10 - 2

search and rescue information ..... ENR 1.10 - 21

special requirements flight ..... ENR 1.1 - 68

submission subject to ATS workload ..... ENR 1.10 - 2

submission timing ..... ENR 1.10 - 3

submitted in-flight ..... ENR 1.1 - 41

surveillance equipment entry ..... ENR 1.10 - 12

to a mobile destination ..... ENR 1.10 - 5

travel flights ..... ENR 1.10 - 2

unlit military aircraft operations ..... ENR 1.1 - 63

use of flight note ..... ENR 1.10 - 3

user guide ..... ENR 1.10 - 10

variation of SAR requirements ..... ENR 1.10 - 3

VFR flights ..... ENR 1.1 - 7

VFR requirements ..... ENR 1.10 - 2, ENR 1.10 - 3

VFR SARTIME ..... ENR 1.10 - 2

ZZZZ aerodrome abbreviation ..... ENR 1.10 - 14

ZZZZ aircraft identification ..... ENR 1.10 - 10

ZZZZ aircraft type ..... ENR 1.10 - 10

flight plan

    flight detail submission requirement ..... ENR 1.10 - 4

    form availability ..... ENR 1.10 - 4

    methods of submission/distribution ..... ENR 1.11 - 1

    military aircraft requirements ..... ENR 1.10 - 4

flight planning restrictions publication details ..... ENR 3 - 1

flight preparation

    forecast not obtained ..... ENR 1.10 - 1

    forecast update requirement ..... ENR 1.10 - 1

    forecast validity period ..... ENR 1.10 - 1

    MET update requirement after delay ..... ENR 1.10 - 1

    preflight briefing ..... ENR 1.10 - 2

    requirements ..... ENR 1.10 - 1

flight rules

    change of ..... ENR 1.10 - 4

flight rules nomination ..... ENR 1.3 - 1

flight visibility

    DME/GPS arrival minima ..... ENR 1.5 - 27

flights

    level selection criteria ..... ENR 1.7 - 3

flow management

    procedures ..... ENR 1.9 - 1

fly neighbourly advice area publication details ..... ENR 5 - 51

fly-down lights ..... AD 1 - 33

forecast

    validity period for flight preparation ..... ENR 1.10 - 1

foreign military

    LAHSO ..... ENR 1.1 - 32

formation flight

    ADF arrangement for break procedure ..... ENR 1.7 - 4

    ADF break procedure and ATC ..... ENR 1.7 - 4

    alternate requirements ..... ENR 1.1 - 53

    ATC will consider formation broken ..... ENR 1.4 - 6

    helicopters ..... ENR 1.1 - 60

    initial and pitch procedure ..... ENR 1.1 - 47

    landing permission ..... ENR 1.1 - 17

    landing sequence number ..... ENR 1.1 - 17

    level assignment ..... ENR 1.7 - 4

    level band assignment ..... ENR 1.7 - 4

    listening watch ..... ENR 1.1 - 17

    separation between aircraft ..... ENR 1.4 - 6

    taxiing ..... ENR 1.1 - 7

FPL

    item 10 standard navigation entries ..... ENR 1.10 - 12

frequency

    strobe lights ..... AD 1 - 23

frequency change

    AP-3C Orion/P-8A Poseidon in AEEZ ..... ENR 1.1 - 64

    area control ..... ENR 1.1 - 10

    established on final from vector ..... ENR 1.6 - 2

    from tower frequency ..... ENR 1.1 - 10

    pilot request ..... ENR 1.1 - 25

frequency change instructions

    departing aircraft ..... ENR 1.1 - 10

fuel

    alternate requirements ..... ENR 1.1 - 51

    emergency fuel status ..... ENR 1.1 - 55

    minimum fuel status ..... ENR 1.1 - 55

    requirements validity for ALTN ..... ENR 1.1 - 52

    thunderstorms or turbulence ..... ENR 1.1 - 51

fuel dumping

    captain's responsibility ..... ENR 1.1 - 57

    criteria ..... ENR 1.1 - 57

full-stop landing

    arriving aircraft ..... ENR 1.1 - 18

    military aerodromes ..... ENR 1.1 - 18

**G**

glide path failure

    pilot action ..... ENR 1.5 - 22

glider operations

    non-controlled aerodrome ..... ENR 1.1 - 40

gliders

    landing separation non-controlled AD ..... ENR 1.1 - 48

    right of way ..... ENR 1.1 - 2

gliding operations

- circuit direction ..... ENR 5 - 49
- contra-circuit procedures ..... ENR 5 - 49
- ground signals ..... ENR 5 - 48
- launch methods ..... ENR 5 - 48
- limitations to aircraft due cable ..... ENR 5 - 48
- listening watch responsibility ..... ENR 5 - 49
- movement and parking areas ..... ENR 5 - 49
- parallel runways ..... ENR 5 - 49
- pilot care ..... ENR 5 - 48
- priority ..... ENR 5 - 49
- publication details ..... ENR 5 - 48
- runway markers ..... ENR 5 - 48
- runway use ..... ENR 5 - 48
- see also gliders
- tow-vehicle driver responsibility ..... ENR 5 - 49
- winch operator responsibility ..... ENR 5 - 49
- wire launching ..... ENR 5 - 49

global navigation satellite system

- see GNSS

global positioning system

- see GPS ..... ENR 1.1 - 23

GLS

- autoland decisions ..... ENR 1.5 - 23
- critical and sensitive areas ..... ENR 1.5 - 23
- final approach course report ..... ENR 1.6 - 2
- when GBAS fails ..... ENR 1.5 - 22

GNSS

- distance reporting procedure ..... ENR 1.1 - 30
- distance reporting to ATS ..... ENR 1.1 - 30
- distance validation ..... ENR 1.1 - 31
- flight notification oceanic/remote areas ..... ENR 2 - 5
- instrument approach procedure ..... ENR 1.5 - 13
- navigation integrity check ..... ENR 2 - 5
- oceanic/remote area requirements ..... ENR 1.10 - 2
- position fixing ..... ENR 1.1 - 23
- prediction analysis ..... ENR 1.10 - 2

GPS

- distance report no RAIM ..... ENR 1.1 - 31
- operations without RAIM ..... ENR 1.1 - 23

graphs

- ACN and LCN ..... AD 1 - 51

ground delay program

- run times ..... ENR 1.9 - 3

ground operation

- turbo-jet aircraft ..... ENR 1.1 - 56

ground signals

- gliding operations ..... ENR 5 - 48
- ground signals to aircraft ..... ENR 1.5 - 29

**H**

handling speeds

- IAL ..... ENR 1.5 - 9
- reversal procedures ..... ENR 1.5 - 9

hazard

- publication of bird hazard ..... ENR 5 - 51

hazard alerts ..... ENR 1.1 - 21

heading

- compensation for wind effect ..... ENR 1.5 - 11



- head-on
  - right of way ..... ENR 1.1 - 2
- helicopter
  - alternate requirements ..... ENR 1.1 - 51
  - IAL ..... ENR 1.5 - 1
  - missed approach procedure ..... ENR 1.5 - 7
- helicopter access corridor
  - formation flights ..... ENR 1.1 - 60
  - listening watch ..... ENR 1.1 - 60
  - procedures ..... ENR 1.1 - 60
- helicopter operations
  - access corridor/lane procedures ..... ENR 1.1 - 60
  - access corridors and lanes ..... ENR 1.1 - 59
  - aerodrome vicinity ..... ENR 1.1 - 59
  - air taxiing procedure use ..... ENR 1.1 - 59
  - air transit procedure ..... ENR 1.1 - 59
  - broadcast of intentions ..... ENR 1.1 - 60
  - circuit entry non-controlled aerodrome ..... ENR 1.1 - 61
  - circuit procedure controlled AD ..... ENR 1.1 - 61
  - departure procedure ..... ENR 1.1 - 60
  - entry gates ..... ENR 1.1 - 60
  - exit gates ..... ENR 1.1 - 59
  - ground taxi procedure use ..... ENR 1.1 - 59
  - IAW ATC instructions ..... ENR 1.1 - 59
  - larger helicopters ..... ENR 1.1 - 59
  - night landing ..... ENR 1.1 - 60
  - noise limits ..... ENR 1.1 - 60
  - non-controlled aerodrome take-off ..... ENR 1.1 - 59
  - pre-position for take-off ..... ENR 1.1 - 60
  - tailwind for landing ..... ENR 1.1 - 60
  - tailwind for take-off ..... ENR 1.1 - 59
  - take-off at night ..... ENR 1.1 - 59
  - take-off clearance ..... ENR 1.1 - 59
  - take-off path ..... ENR 1.1 - 59
  - taxiing at night ..... ENR 1.1 - 59
  - turn after take-off conditions ..... ENR 1.1 - 59
  - wheeled helicopters ..... ENR 1.1 - 59
- helicopter routes publication details ..... ENR 3 - 1
- helicopters
  - aircraft performance category ..... ENR 1.5 - 1
- heliports
  - publication details ..... AD 3 - 1
- HF
  - radio telephony OCTA ..... ENR 1.1 - 49
- holding
  - on runway in use ..... ENR 1.1 - 20
- holding pattern
  - descent ..... ENR 1.5 - 20
  - DME/GPS arrival ..... ENR 1.5 - 27
  - entry ..... ENR 1.5 - 18
  - standard ..... ENR 1.5 - 19
- holding procedure
  - specified pattern ..... ENR 1.5 - 17
- holding procedures
  - bank angle ..... ENR 1.5 - 17
  - DME arc entry ..... ENR 1.5 - 19
  - DME limits ..... ENR 1.5 - 19
  - limitations ..... ENR 1.5 - 17
  - outbound timing ..... ENR 1.5 - 17
  - prolonged ..... ENR 1.5 - 20

sector 1 entry ..... ENR 1.5 - 19  
 sector 2 entry ..... ENR 1.5 - 19  
 sector 3 entry ..... ENR 1.5 - 19  
 shape ..... ENR 1.5 - 17  
 shortening ..... ENR 1.5 - 20  
 speed ..... ENR 1.5 - 17  
 terminology ..... ENR 1.5 - 17  
 turn direction ..... ENR 1.5 - 17  
 turns ..... ENR 1.5 - 17  
 wind allowance ..... ENR 1.5 - 17  
 hold-short  
 lights ..... AD 1 - 28

**I**

**IAP**

APV ..... ENR 1.5 - 3  
 bank angle ..... ENR 1.5 - 11  
 circling approach ..... ENR 1.5 - 2  
 classified PA, APV or NPA ..... ENR 1.5 - 12  
 descent ..... ENR 1.5 - 11  
 descent gradients ..... ENR 1.5 - 11  
 enter CTA on missed approach ..... ENR 1.1 - 13  
 handling speeds ..... ENR 1.5 - 9  
 minimum route altitude requirements ..... ENR 1.5 - 1  
 missed approach lateral guidance ..... ENR 1.5 - 6  
 navigation aid usage ..... ENR 1.5 - 12  
 NPA as 2D or 3D ..... ENR 1.5 - 12  
 NPA with distance measuring ..... ENR 1.5 - 12  
 NPA without distance measuring ..... ENR 1.5 - 13  
 obstacle clearance ..... ENR 1.5 - 3  
 procedure entry ..... ENR 1.5 - 13  
 reversal procedure descent ..... ENR 1.5 - 11  
 spot height caution ..... ENR 1.5 - 2  
 straight-in NPA ..... ENR 1.5 - 3  
 use of area QNH ..... ENR 1.5 - 21  
 visual circling ..... ENR 1.5 - 2

**identification**

radar service ..... ENR 1.6 - 1

**identification (SPI) function**

use in radio failure ..... ENR 1.6 - 4

**identification function (SPI)**

pilot operation ..... ENR 1.6 - 5

**IFR**

alternate AD provision ..... ENR 1.1 - 53  
 alternate minima ..... ENR 1.1 - 52  
 altimeter accuracy ..... ENR 1.7 - 1  
 amended route/level notification ..... ENR 1.1 - 41  
 block levels ..... ENR 1.7 - 4  
 change of level prior action ..... ENR 1.7 - 5  
 class E ..... ENR 1.1 - 21  
 cruising levels table for south of 80°s ..... ENR 1.7 - 6  
 cruising levels table north of 80°S ..... ENR 1.7 - 5  
 establish on departure track ..... ENR 1.1 - 41  
 flight criteria ..... ENR 1.3 - 1  
 flight notification requirements ..... ENR 1.10 - 2  
 frequency change to CTAF ..... ENR 1.1 - 42  
 local training SARWATCH ..... ENR 1.1 - 42  
 LSALT,MSA,MVA ..... ENR 1.1 - 9  
 military aircraft not able to comply ..... ENR 1.1 - 69  
 military flight notification requirements ..... ENR 1.10 - 3

navigation .....	ENR 1.1 - 21
non-controlled aerodrome radio procedure .....	ENR 1.1 - 37
position report prior to descent .....	ENR 1.1 - 42
route requirements .....	ENR 1.1 - 24
SAR requirements OCTA .....	ENR 1.1 - 25
scheduled report for area flights .....	ENR 1.1 - 42
unable to comply with cruising level .....	ENR 1.7 - 3
VFR climb and descent .....	ENR 1.1 - 10
VFR on top .....	ENR 1.1 - 11
visual approach by day .....	ENR 1.1 - 14
visual approach by night .....	ENR 1.1 - 14
visual departure .....	ENR 1.1 - 9
waypoint codes, publication details .....	ENR 4 - 1
<b>IFR flight</b>	
departing class A,C,D,E airspace .....	ENR 1.1 - 13
<b>IFR holding patterns</b>	
avoidance by VFR aircraft .....	ENR 1.1 - 21
<b>ILS</b>	
altimeter checks .....	ENR 1.5 - 23
back beam radiation .....	ENR 1.5 - 22
course reversals .....	ENR 1.5 - 22
critical and sensitive area protection .....	AD 1 - 4
critical and sensitive areas .....	AD 1 - 4
glide path failure .....	ENR 1.5 - 22
localiser guided take-off .....	AD 1 - 4
locator failure .....	ENR 1.5 - 22
marker beacon failure .....	ENR 1.5 - 22
on localiser report .....	ENR 1.6 - 2
<b>immigration &amp; border protection</b>	
reporting unusual activity .....	ENR 1.1 - 56
<b>in-company flights</b>	
separation .....	ENR 1.4 - 6
<b>initial and pitch procedure</b> .....	ENR 1.1 - 47
<b>instrument approach procedures</b>	
below ISA conditions .....	ENR 1.5 - 20
helicopter .....	ENR 1.5 - 1
level restriction .....	ENR 1.1 - 14
procedure entry .....	ENR 1.5 - 2
see also IAL	
specific approach request .....	ENR 1.1 - 13
use of DME/GPS steps .....	ENR 1.5 - 27
visual segment .....	ENR 1.5 - 7
<b>instrument flight rules (IFR)</b> .....	ENR 1.3 - 1
<b>instrument missed approach procedure</b>	
VMC .....	ENR 1.1 - 20
<b>intensity table for multi-stage lights</b> .....	AD 1 - 31
<b>interception of civil aircraft</b> .....	ENR 1.12 - 1
<b>irregular operation</b>	
navigation or communication service .....	ENR 1.1 - 55
pilot report .....	ENR 1.1 - 55
<b>L</b>	
<b>LAHSO</b>	
active participation .....	ENR 1.1 - 31
aerodromes .....	ENR 1.1 - 31
ATIS broadcast .....	ENR 1.1 - 33
clearance .....	AD 1 - 28
conditions for operation .....	ENR 1.1 - 32
distance to go sign .....	AD 1 - 22
foreign military .....	ENR 1.1 - 32

go around, provision ..... ENR 1.1 - 33

holding position markings ..... AD 1 - 17

landing distance assessment ..... ENR 1.1 - 33

landing distance available ..... ENR 1.1 - 33

lights ..... AD 1 - 28

locations used ..... ENR 1.1 - 31

non-participation ..... ENR 1.1 - 33

notification of withdrawal ..... ENR 1.1 - 32

passive participation ..... ENR 1.1 - 31

pilot advice to ATC ..... ENR 1.1 - 33

pilot responsibility ..... ENR 1.1 - 33

read back requirement ..... ENR 1.1 - 33

requirement to hold short ..... ENR 1.1 - 32

runway hold short markings ..... AD 1 - 12

runway intersection sign ..... AD 1 - 23

taxiway holding markings diagram ..... AD 1 - 17

traffic information ..... ENR 1.1 - 33

wind conditions ..... ENR 1.1 - 32

landing ..... ENR 1.1 - 16

    after preceding departing aircraft ..... ENR 1.1 - 17

    after preceding landing aircraft ..... ENR 1.1 - 17

    close to edges of pavements ..... AD 1 - 45

    crosswind component ..... ENR 1.1 - 16

    formation ..... ENR 1.1 - 17

    helicopter ..... ENR 1.1 - 17

    helicopters at night ..... ENR 1.1 - 60

    minima ..... ENR 1.1 - 17

    nominated runway ..... ENR 1.1 - 16

    operational information ..... ENR 1.1 - 16

    right of way ..... ENR 1.1 - 2

    runway suitability ..... ENR 1.1 - 42

    separation non-controlled aerodrome ..... ENR 1.1 - 48

    taxi requirements non-controlled AD ..... ENR 1.1 - 48

    touch and go ..... ENR 1.1 - 18

landing clearance

    runway separation ..... ENR 1.1 - 17

landing sequence

    military aircraft ..... ENR 1.1 - 17

lanes of entry

    definition ..... ENR 1.4 - 11

    lighting ..... AD 1 - 32

    operating requirements ..... ENR 1.4 - 11

lanes-of-entry publication details ..... ENR 3 - 1

lateral separation

    military CTA no radar ..... ENR 1.4 - 7

launch methods

    gliding operations ..... ENR 5 - 48

LCN

    conversion graph ..... AD 1 - 50

    definition ..... AD 1 - 49

    graphs ..... AD 1 - 49

    worked example ..... AD 1 - 49

level

    advising last assigned ..... ENR 1.1 - 10

level assignment

    class A,C,D and IFR class E ..... ENR 1.1 - 12

levels

    priority for standard levels ..... ENR 1.7 - 4

    request due operational requirement ..... ENR 1.7 - 3

    restriction on instrument approach ..... ENR 1.1 - 14

    selection criteria when planning ..... ENR 1.7 - 3

light signals

- to aircraft ..... ENR 1.5 - 28
- to vehicles and pedestrians ..... ENR 1.5 - 28

lighting

- aerodrome beacon ..... AD 1 - 32
- Army alternate requirements ..... ENR 1.1 - 53
- Army SI - minimum lighting requirements ..... ENR 1.1 - 55
- displaced threshold diagrams ..... AD 1 - 24
- obstacle ..... AD 1 - 20
- obstacle lighting ..... AD 1 - 32
- pilot activated lighting (PAL) ..... AD 1 - 32
- responsible person definition ..... ENR 1.1 - 54
- temporarily displaced threshold ..... AD 1 - 8

lights

- aerodrome beacon ..... ENR 4 - 1
- apron ..... AD 1 - 28
- apron exit ..... AD 1 - 27
- Army aircraft ..... ENR 1.1 - 4
- arrestor barrier ..... AD 1 - 27
- description ..... AD 1 - 28
- diagram ..... AD 1 - 28
- distance to run markers ..... AD 1 - 26
- en route and ground ..... ENR 4 - 1
- fly-down ..... AD 1 - 33
- gliding operations cable deployment ..... ENR 5 - 49
- hazard beacon ..... ENR 4 - 1
- holding point ..... AD 1 - 27
- hold-short ..... AD 1 - 28
- hookcable markers ..... AD 1 - 26
- intensity table ..... AD 1 - 31
- LAHSO ..... AD 1 - 28
- multi-stage precision approach ..... AD 1 - 31
- PAPI ..... AD 1 - 35
- permanent threshold ..... AD 1 - 23
- precision approach CAT I ..... AD 1 - 30
- precision approach CAT II and CAT III ..... AD 1 - 31
- precision approach runway ..... AD 1 - 25
- rapid-exit ..... AD 1 - 27
- runway centreline ..... AD 1 - 26
- runway edge ..... AD 1 - 25
- runway edge directionality ..... AD 1 - 25
- runway edge spacing ..... AD 1 - 25
- runway end ..... AD 1 - 25
- runway exit ..... AD 1 - 27
- runway guard ..... AD 1 - 28
- stopway ..... AD 1 - 26
- strobe frequency ..... AD 1 - 23
- strobes ..... AD 1 - 23
- taxiway centreline ..... AD 1 - 27
- taxiway edge ..... AD 1 - 27
- temporarily displaced threshold ..... AD 1 - 23, AD 1 - 24
- threshold ..... AD 1 - 23
- threshold alternate standard pattern ..... AD 1 - 23
- threshold standard pattern ..... AD 1 - 23
- touchdown zone ..... AD 1 - 26
- T-VASIS ..... AD 1 - 33
- unserviceable area near threshold ..... AD 1 - 24
- unserviceable movement area ..... AD 1 - 26
- VASIS ..... AD 1 - 33
- wind indicator ..... AD 1 - 32

limitations

- holding procedures ..... ENR 1.5 - 17

listening watch  
 helicopter access corridor ..... ENR 1.1 - 60

LJR  
 flight notification ..... ENR 1.10 - 5  
 notification requirement ..... ENR 1.10 - 5

load classification number  
 see LCN

local instructions  
 flight detail requirements ..... ENR 1.10 - 4

locked wheels ..... AD 1 - 45

low flying  
 army ..... ENR 1.1 - 1

low flying definition ..... ENR 1.1 - 1

low jet route (LJR)  
 abort procedure ..... ENR 1.1 - 65  
 bounce aircraft flight plan ..... ENR 1.1 - 65  
 broadcast of progress ..... ENR 1.1 - 65  
 notification to AsA ..... ENR 1.1 - 65  
 operating levels ..... ENR 1.1 - 65  
 restricted area ..... ENR 1.1 - 65  
 scope ..... ENR 1.1 - 65  
 track requirements ..... ENR 1.1 - 65

low visibility procedures  
 description ..... AD 1 - 3  
 notification to pilots ..... AD 1 - 3

lower ATS routes publication details ..... ENR 3 - 1

LSALT  
 IAL requirements ..... ENR 1.5 - 1

**M**

mach number technique  
 airspace ..... ENR 2 - 1  
 block level separation ..... ENR 1.7 - 4  
 description ..... ENR 2 - 1  
 oceanic control area ..... ENR 2 - 1

MAHWP ..... ENR 1.5 - 7

MAPT ..... ENR 1.5 - 6, ENR 1.5 - 15  
 missed approach procedure ..... ENR 1.5 - 15

maritime surveillance  
 australian economic exclusion zones ..... ENR 1.1 - 64

marker beacons  
 failure, ILS requirements ..... ENR 1.5 - 22

markings  
 obstacle ..... AD 1 - 20  
 obstacle criteria ..... AD 1 - 20

MARSA  
 authorisation ..... ENR 1.1 - 58  
 clearance ..... ENR 1.1 - 58  
 conditions of use ..... ENR 1.1 - 58  
 definition ..... ENR 1.1 - 58  
 flight notification ..... ENR 1.1 - 58  
 nature of operations ..... ENR 1.1 - 58  
 separation responsibility ..... ENR 1.1 - 58

MATWP ..... ENR 1.5 - 7

MDA  
 calculation ..... ENR 1.5 - 20  
 descent limitations when circling ..... ENR 1.5 - 2

military  
 see also ADF, Army, RAAF, RAN  
 FPL military specific entries ..... ENR 1.10 - 22

- level assignment for cloud break ..... ENR 1.6 - 6
- QNH procedures ..... ENR 1.7 - 3
- temporarily displaced threshold markings ..... AD 1 - 8
- military aircraft
  - flight notification when unlit ..... ENR 1.1 - 63
  - flight plan submission requirements ..... ENR 1.10 - 4
  - landing sequence ..... ENR 1.1 - 17
  - operational control ..... ENR 1.1 - 69
- military CTA
  - clearance ..... ENR 1.4 - 7
  - lateral separation ..... ENR 1.4 - 7
  - separation ..... ENR 1.4 - 7
  - separation VMC no radar ..... ENR 1.4 - 7
  - vertical separation ..... ENR 1.4 - 7
- military CTR
  - definition ..... ENR 1.4 - 4
  - hours of operation ..... ENR 1.4 - 4
- military flight
  - operations preclude IFR compliance ..... ENR 1.1 - 69
- military flights
  - taxi clearance ..... ENR 1.1 - 7
- military installations
  - aerial photography criteria ..... ENR 1.1 - 57
- military training area
  - separation variations ..... ENR 1.4 - 7
- military training areas
  - separation ..... ENR 1.4 - 7
- minima
  - reduction using actual QNH ..... ENR 1.5 - 21
- minimum safe height
  - exemptions ..... ENR 1.1 - 1
  - helicopters ..... ENR 1.1 - 1
  - parameters ..... ENR 1.1 - 1
- minimum sector altitude
  - see MSA
- missed approach
  - climb gradient ..... ENR 1.5 - 6
  - from visual circling ..... ENR 1.5 - 6
  - GPS guidance ..... ENR 1.5 - 7
  - helicopter requirements ..... ENR 1.5 - 7
  - initiated prior to MAPT ..... ENR 1.5 - 6
  - initiation criteria ..... ENR 1.5 - 15
  - MAHWP ..... ENR 1.5 - 7
  - MAPT ..... ENR 1.5 - 15
  - MATWP ..... ENR 1.5 - 7
  - obstacle clearance ..... ENR 1.5 - 6
  - RNAV GNSS ..... ENR 1.5 - 7
  - standard procedure ..... ENR 1.5 - 6
  - visual segment ..... ENR 1.5 - 7
  - with/without lateral guidance ..... ENR 1.5 - 7
- mode S
  - operating requirements ..... ENR 1.1 - 50
- MSA
  - IAL requirements ..... ENR 1.5 - 1
  - obstacle clearance ..... ENR 1.5 - 12
  - sector ..... ENR 1.5 - 12
- multi-engine aircraft
  - RFF standby for training ..... ENR 1.1 - 57
- multi-stage intensity lights
  - operation ..... AD 1 - 31

**N**

NAIPS  
 common name entry ..... ENR 1.10 - 5

NAP  
 alternative climb procedures ..... ENR 1.5 - 25  
 departure procedures ..... ENR 1.5 - 25  
 flight paths ..... ENR 1.5 - 25  
 outside tower hours ..... ENR 1.5 - 25  
 runway selection factors ..... ENR 1.5 - 25  
 wind shear ..... ENR 1.5 - 25

navigation  
 VFR limitations ..... ENR 1.1 - 22

navigation aids  
 order of precision ..... ENR 1.1 - 22

NDB failure  
 pilot action ..... ENR 1.5 - 22

night azimuth  
 T-VASIS ..... AD 1 - 33

night landing  
 helicopter requirements ..... ENR 1.1 - 60

night vision goggles  
 see NVG

NOCOM  
 ATC approval ..... ENR 1.1 - 13  
 flight notification ..... ENR 1.10 - 7  
 QNH requirement ..... ENR 1.7 - 3

noise abatement procedures  
 see NAP

noise limits  
 helicopter operations ..... ENR 1.1 - 60

nominated runway  
 landing ..... ENR 1.1 - 16

nomination of flight rules ..... ENR 1.3 - 1

non-controlled aerodrome  
 circuit direction ..... ENR 1.1 - 39  
 circuit entry for helicopters ..... ENR 1.1 - 61  
 circuit heights ..... ENR 1.1 - 40  
 circuit procedure for helicopters ..... ENR 1.1 - 61  
 collision avoidance ..... ENR 1.1 - 48  
 glider landing separation ..... ENR 1.1 - 48  
 gliders ..... ENR 1.1 - 40  
 helicopter take-off ..... ENR 1.1 - 59  
 IFR taxi report ..... ENR 1.1 - 40  
 joining for landing ..... ENR 1.1 - 42  
 landing separation ..... ENR 1.1 - 48  
 operating procedures ..... ENR 1.1 - 42  
 segmented circle circuit indicator ..... AD 1 - 37  
 separation minima ..... ENR 1.1 - 40  
 straight-in approach ..... ENR 1.1 - 45

non-controlled airspace  
 class G airspace ..... ENR 1.4 - 8  
 surveillance information service ..... ENR 1.6 - 3

non-scheduled aircraft  
 parking ..... AD 1 - 42

notification  
 activities dangerous to aviation ..... ENR 5 - 47  
 dangerous cargo ..... ENR 1.1 - 18  
 explosive weapons stores ..... ENR 1.1 - 18

NPA  
 runway alignment ..... ENR 1.5 - 3  
 visual manoeuvring in circuit ..... ENR 1.5 - 3



NVD  
 army alternate requirements ..... ENR 1.1 - 51

NVG  
 consequences of use for ATC ..... ENR 1.1 - 63

**O**

OARP  
 information availability ..... ENR 1.1 - 24

object towing ..... ENR 1.1 - 1

obstacle  
 lighting ..... AD 1 - 20  
 marking criteria ..... AD 1 - 20  
 markings ..... AD 1 - 20

obstacle clearance  
 IAL requirements ..... ENR 1.5 - 3  
 missed approach ..... ENR 1.5 - 6  
 MSA ..... ENR 1.5 - 12  
 VASIS ..... AD 1 - 33

obstacle clearance altitude  
 definition ..... ENR 1.5 - 10

obstacles  
 identified on aeronautical maps ..... ENR 5 - 48  
 LSALT calculation ..... ENR 5 - 48  
 navigational tolerance areas ..... ENR 5 - 48

obstruction  
 lights for runway unserviceable area ..... AD 1 - 24

OCA  
 clearance requirements ..... ENR 2 - 1  
 lateral offsets ..... ENR 2 - 4  
 mach number technique ..... ENR 2 - 1  
 operations ..... ENR 2 - 1

oceanic control area  
 see OCA

OCTA  
 SAR requirements for IFR ..... ENR 1.1 - 25

off air route planning manual  
 information availability ..... ENR 1.1 - 24

operating level  
 LJR ..... ENR 1.1 - 65

operational control  
 military aircraft responsibility ..... ENR 1.1 - 69

operational readiness platform (ORP)  
 approval for use ..... ENR 1.1 - 69  
 displaced threshold ..... ENR 1.1 - 69  
 overnight parking requirements ..... ENR 1.1 - 69

operational requirement  
 created or removed by TAF ..... ENR 1.1 - 52

operations  
 Class E airspace ..... ENR 1.1 - 21  
 due regard ..... ENR 1.1 - 58  
 environmental limitations ..... ENR 1.1 - 57  
 unrated pavement ..... AD 1 - 45

operations normal  
 IFR report ..... ENR 1.1 - 42

ops normal ..... ENR 1.10 - 7

outbound timing  
 holding procedures ..... ENR 1.5 - 17

overnight parking  
 ORP ..... ENR 1.1 - 69

overtaking ..... ENR 1.1 - 2  
 right of way ..... ENR 1.1 - 2  
 taxiing ..... ENR 1.1 - 3  
 over-water flight  
 route deviation ..... ENR 1.1 - 23

**P**

P-8A Poseidon  
 operations in AEEZ ..... ENR 1.1 - 64  
 PAL  
 alternate requirements ..... ENR 1.1 - 53  
 description ..... AD 1 - 32  
 wind indicator ..... AD 1 - 32  
 PAPI  
 approach angle ..... AD 1 - 35  
 colour distortion ..... AD 1 - 36  
 four red zone ..... AD 1 - 36  
 light configuration ..... AD 1 - 35  
 lights ..... AD 1 - 33  
 operating requirement ..... AD 1 - 36  
 signal diagrams ..... AD 1 - 35  
 T-VASIS comparison ..... AD 1 - 36  
 parachute operations  
 ATC separation service ..... ENR 5 - 49  
 procedures ..... ENR 5 - 49  
 traffic information ..... ENR 5 - 49  
 paragraph 6.1 ..... ENR 1.9 - 2  
 parallel runways  
 gliding operations ..... ENR 5 - 49  
 parking  
 availability for non-scheduled aircraft ..... AD 1 - 42  
 pavement  
 aircraft operations ADF aerodromes ..... AD 1 - 46  
 care ..... AD 1 - 45  
 classification ..... AD 1 - 41  
 criteria for aircraft use ..... AD 1 - 44  
 evaluation method ..... AD 1 - 42  
 parameters for aircraft below 5700KG ..... AD 1 - 42  
 parameters to specify strength ..... AD 1 - 42  
 prevention of damage ..... AD 1 - 42  
 rating system ADF aerodromes ..... AD 1 - 45  
 subgrade strength ..... AD 1 - 42  
 technical advice on classification ..... AD 1 - 41  
 type ..... AD 1 - 42  
 unrated strength ..... AD 1 - 45  
 pavement classification number (PCN) ..... AD 1 - 41  
 pavement concession  
 ADF airfields ..... AD 1 - 45  
 aircraft captain responsibility ..... AD 1 - 41  
 civil airfield ..... AD 1 - 45  
 criteria for non-requirement ..... AD 1 - 49  
 example of determining requirement ..... AD 1 - 44  
 pavement strength ..... AD 1 - 41  
 ADF aerodromes ..... AD 1 - 46  
 PBN  
 FPL entries ..... ENR 1.10 - 4  
 guidance information ..... ENR 1.10 - 17  
 pilot responsibility  
 aerial photography and survey ..... ENR 1.1 - 57

ATC response not received to 7600 code ..... ENR 1.6 - 4

change of level ..... ENR 1.7 - 4

change of level report ..... ENR 1.7 - 4

clearance ..... ENR 1.1 - 56

diversion ..... ENR 1.1 - 49

DME/GPS arrival containment ..... ENR 1.5 - 27

flight notification amendment ..... ENR 1.10 - 6

flight preparation requirements ..... ENR 1.10 - 1

formation separation ..... ENR 1.1 - 66

gliding operations ..... ENR 5 - 48

GNSS position reporting ..... ENR 1.1 - 30

IAL spot heights ..... ENR 1.5 - 2

IFR cruising levels ..... ENR 1.7 - 3

IFR level change ..... ENR 1.7 - 5

LAHSO lights ..... AD 1 - 28

locating winch, tow car and cable ..... ENR 5 - 48

loss of two way COM ..... ENR 1.6 - 4

mach number technique ..... ENR 2 - 1

MARSA ..... ENR 1.1 - 58

obstacle clearance ..... ENR 1.5 - 3

operating within block levels ..... ENR 1.7 - 4

PAPI ..... AD 1 - 36

pavement care ..... AD 1 - 45

pavement classification validation ..... AD 1 - 41

photography of military facilities ..... ENR 1.1 - 57

RAIM not available ..... ENR 1.1 - 31

reach level by specific parameters ..... ENR 1.7 - 4

route deviation OCA ..... ENR 1.1 - 23

specified rate ..... ENR 1.7 - 5

SSR code change ..... ENR 1.6 - 5

take-off ..... ENR 1.1 - 2

transponder code selection ..... ENR 1.6 - 5

T-VASIS ..... AD 1 - 36

unlawful interference ..... ENR 1.6 - 4, ENR 1.13 - 1

vector ..... ENR 1.6 - 1

visual departure ..... ENR 1.1 - 9

pilot-interpreted approach

vector ..... ENR 1.6 - 1

POB

military flights ..... ENR 1.1 - 39

police operations

call-sign ..... ENR 1.1 - 57

portable lighting

alternate requirement ..... ENR 1.1 - 53

position

service advice to aircraft ..... ENR 1.6 - 2

position fixing ..... ENR 1.1 - 23

position information

vector format ..... ENR 1.6 - 2

position report

en-route ..... ENR 1.1 - 12

exemption ..... ENR 1.1 - 13

format ..... ENR 1.1 - 12, ENR 1.1 - 42

impending ..... ENR 1.1 - 12, ENR 1.1 - 41

over a town ..... ENR 1.1 - 24

procedure prior to ..... ENR 1.1 - 12

requirements ..... ENR 1.1 - 42

revised estimate ..... ENR 1.1 - 41

position reporting points

specifications ..... ENR 1.1 - 24

positive fix  
 definition ..... ENR 1.1 - 23

positive radio fix  
 intervals ..... ENR 1.1 - 22

PRD areas  
 publication details ..... ENR 5 - 1

precision approach  
 CAT I lighting diagram ..... AD 1 - 30  
 CAT II lighting diagram ..... AD 1 - 31  
 runway lights ..... AD 1 - 31  
 RV limitations ..... ENR 1.5 - 20  
 taxiway holding markings ..... AD 1 - 17  
 taxiway markings diagram ..... AD 1 - 17

precision approach runway lights ..... AD 1 - 25

pre-departure clearance ..... ENR 1.1 - 6

pre-flight  
 altimeter accuracy check ..... ENR 1.7 - 1

preflight briefing  
 update procedure ..... ENR 1.10 - 2  
 validity ..... ENR 1.10 - 2

priority  
 ATC assessment of ..... ENR 1.4 - 11  
 gliding operations ..... ENR 5 - 49  
 police operations ..... ENR 1.1 - 57

procedure turn ..... ENR 1.5 - 15

proximity ..... ENR 1.1 - 2

push back  
 request ..... ENR 1.1 - 7

**Q**

**QNH**

and instrument approach procedure ..... ENR 1.5 - 21

definition of accuracy ..... ENR 1.7 - 1

sources ..... ENR 1.5 - 21

special military procedures ..... ENR 1.7 - 3

TAF QNH on ATIS ..... ENR 1.5 - 21

validity ..... ENR 1.7 - 2

validity time for instrument approach ..... ENR 1.5 - 21

**R**

**RAAF**

see also ADF, Military

airborne early warning and control (AEW&C) ..... ENR 1.1 - 76

air-to-air refuelling ..... ENR 1.1 - 69

balloon flight ..... ENR 5 - 50

fighter scrambles ..... ENR 1.1 - 8

MLJ operations ..... ENR 1.1 - 65

ORP operations ..... ENR 1.1 - 69

towing objects ..... ENR 1.1 - 3

**radar**

SID ..... ENR 1.5 - 23

**radar service**

AACC established ..... ENR 1.6 - 1

AACC not established ..... ENR 1.6 - 1

identification ..... ENR 1.6 - 1

pilot request ..... ENR 1.6 - 1

radar failure ..... ENR 1.6 - 4

scope ..... ENR 1.6 - 1

**radar terrain clearance chart**

description ..... ENR 1.5 - 1

MSA differences ..... ENR 1.5 - 1

radar vector  
 agreed rate turns ..... ENR 1.6 - 1

radio communications  
 exemptions ..... ENR 1.1 - 24  
 failure of required equipment ..... ENR 1.1 - 29  
 requirements ..... ENR 1.1 - 24

radio failure  
 Australian domestic airspace ..... ENR 1.1 - 30  
 Australian oceanic airspace ..... ENR 1.1 - 30  
 whilst being vectored ..... ENR 1.6 - 3

radio navigation aids  
 precision order ..... ENR 1.1 - 22  
 publication details ..... ENR 4 - 1

radio navigation systems  
 flight notification ..... ENR 1.1 - 22

radio telephony  
 requirements OCTA ..... ENR 1.1 - 49

RAIM  
 missed approach due to loss ..... ENR 1.5 - 7  
 warning consequences ..... ENR 1.5 - 7

RAN  
 see also ADF, Military  
 ELVA minima ..... ENR 1.1 - 50  
 helicopter alternate planning ..... ENR 1.1 - 50  
 helicopter external load operations ..... ENR 1.1 - 3  
 helicopter requirements for ALTN ..... ENR 1.1 - 50  
 minimum safe height over water ..... ENR 1.1 - 1  
 towing objects ..... ENR 1.1 - 3

rapid-exit lights ..... AD 1 - 27

rate one turn ..... ENR 1.5 - 11

read back  
 LAHSO ..... ENR 1.1 - 33  
 transponder code ..... ENR 1.6 - 5

recall  
 military aircraft due weather ..... ENR 1.1 - 69

reckless operation of aircraft ..... ENR 1.1 - 2

reduced vertical separation minima  
 see RVSM

regional supplementary procedures ..... ENR 1.8 - 1

remotely piloted aircraft system  
 see RPAS

report  
 ETA ..... ENR 1.1 - 12  
 maintaining assigned level ..... ENR 1.1 - 41

reporting  
 flight level deviation ..... ENR 1.1 - 36  
 unusual activities ..... ENR 1.1 - 56

reporting schedule  
 VFR ..... ENR 1.10 - 3

reversal procedures  
 approach procedures ..... ENR 1.5 - 15  
 base turn entry ..... ENR 1.5 - 16  
 description ..... ENR 1.5 - 15  
 entry ..... ENR 1.5 - 16  
 types ..... ENR 1.5 - 15

RFF service  
 standby for multi-engine training ..... ENR 1.1 - 57

right of way ..... ENR 1.1 - 2  
 landing ..... ENR 1.1 - 2

route  
 flight notification format .....ENR 1.10 - 15  
 route specification ..... ENR 1.1 - 24  
     unpublished route ..... ENR 3 - 1  
 routes in Australian FIRs publication details .....ENR 3 - 1  
 RPAS  
     SSR code .....ENR 1.6 - 4, ENR 1.6 - 5  
 RTCC  
     see radar terrain clearance chart  
 runway  
     aiming point markings ..... AD 1 - 11  
     approach lighting ..... AD 1 - 29  
     arrestor system hookcable markers ..... AD 1 - 15  
     arrestor system warning marker ..... AD 1 - 16  
     blast area markings ..... AD 1 - 11  
     boundary marker intervals ..... AD 1 - 5  
     centre line markings ..... AD 1 - 11  
     centreline lights ..... AD 1 - 26  
     distance to run markers ..... AD 1 - 13  
     edge light directionality ..... AD 1 - 25  
     edge lighting ..... AD 1 - 25  
     edge lighting spacing ..... AD 1 - 25  
     end lights ..... AD 1 - 25  
     exit lights ..... AD 1 - 27  
     exit sign ..... AD 1 - 21  
     guard lights ..... AD 1 - 28  
     LAHSO hold-short markings ..... AD 1 - 12  
     landing suitability ..... ENR 1.1 - 42  
     markings ..... AD 1 - 7  
     markings beyond runway end ..... AD 1 - 11  
     markings, runway used for taxiing ..... AD 1 - 12  
     runway entry clearance ..... ENR 1.1 - 8  
     runway intersection sign ..... AD 1 - 23  
     runway marker description ..... AD 1 - 6  
     runway numbers ..... AD 1 - 12  
     runway side stripe and end markings ..... AD 1 - 10  
     strobe lights ..... AD 1 - 23  
     temporarily displaced threshold strobe lights ..... AD 1 - 8  
     temporary threshold NOTAM advice ..... AD 1 - 8  
     threshold identification lights ..... AD 1 - 23  
     threshold marking diagrams ..... AD 1 - 7  
     threshold markings ..... AD 1 - 7  
     touchdown zone lighting ..... AD 1 - 26  
     touchdown zone markings ..... AD 1 - 11  
 runway selection  
     NAPS ..... ENR 1.5 - 25  
 runway separation  
     landing minima ..... ENR 1.1 - 17  
 runway strip  
     gliding operations ..... ENR 5 - 48  
 Runway Visibility (RV)  
     limitations ..... ENR 1.5 - 20  
 runway visibility (RV) ..... ENR 1.5 - 20  
 runway visual range (RVR) ..... ENR 1.5 - 20  
 RVSM  
     cruising levels ..... ENR 1.1 - 34  
     OCA class A ..... ENR 1.1 - 35  
     operations in RVSM airspace ..... ENR 1.1 - 35  
     procedures before entering ..... ENR 1.1 - 34  
     state aircraft non RVSM-approved ..... ENR 1.1 - 34

state aircraft priority ..... ENR 1.1 - 34

**S**

SAR alerting  
 flight information area ..... ENR 1.4 - 8

SARTIME  
 cancellation ..... ENR 1.1 - 49  
 contact details at destination ..... ENR 1.10 - 3  
 currency ..... ENR 1.1 - 49  
 details required from pilot ..... ENR 1.10 - 3  
 flight notification ..... ENR 1.1 - 49  
 flight notification requirements ..... ENR 1.10 - 2  
 flight notification via internet ..... ENR 1.10 - 2  
 nomination at non-controlled aerodrome ..... ENR 1.1 - 37  
 pilot responsibility ..... ENR 1.1 - 49  
 pilot responsibility for departure ..... ENR 1.1 - 49  
 pre take-off advice of flight change ..... ENR 1.10 - 6  
 requirements for nomination ..... ENR 1.10 - 7  
 validity ..... ENR 1.10 - 3, ENR 1.10 - 7

SARWATCH  
 cancellation ..... ENR 1.1 - 48  
 local training by IFR ..... ENR 1.1 - 42  
 when to cancel ..... ENR 1.1 - 49

scheduled reporting ..... ENR 1.1 - 12  
 IFR area flights ..... ENR 1.1 - 42  
 intervals ..... ENR 1.1 - 24  
 when holding ..... ENR 1.1 - 42

scrambles ..... ENR 1.1 - 8

sector 1 entry  
 holding procedures ..... ENR 1.5 - 19

sector 2 entry  
 holding procedures ..... ENR 1.5 - 19

sector 3 entry  
 holding procedures ..... ENR 1.5 - 19

segment parameters  
 approach procedures ..... ENR 1.5 - 14  
 table ..... ENR 1.5 - 14

segments  
 approach procedures ..... ENR 1.5 - 14

Separation  
 controlled airspace ..... ENR 1.4 - 5

separation  
 Class E airspace ..... ENR 1.1 - 21  
 DME based using GNSS ..... ENR 1.1 - 30  
 formation take-off ..... ENR 1.1 - 8  
 in-company flights ..... ENR 1.4 - 6  
 mach number technique ..... ENR 2 - 1  
 MARSAs operations ..... ENR 1.1 - 58  
 military CTA ..... ENR 1.4 - 7  
 military CTA no radar ..... ENR 1.4 - 7  
 RAIM ..... ENR 1.1 - 24  
 scrambles ..... ENR 1.1 - 9  
 special provisions ..... ENR 1.4 - 6

separation minima  
 non-controlled aerodrome ..... ENR 1.1 - 40

separation standards  
 approved variations ..... ENR 1.4 - 7  
 VIP ..... ENR 1.4 - 7  
 visiting military aircraft ..... ENR 1.4 - 7

service

- COM failure action using SPI ..... ENR 1.6 - 4
- position advice to aircraft ..... ENR 1.6 - 2

services and requirements

- classes of airspace ..... ENR 1.4 - 9

shape

- holding procedures ..... ENR 1.5 - 17

SID/SRD procedures

- variation to separation ..... ENR 1.4 - 7

SIS

- class E airspace ..... ENR 1.1 - 21
- within class E airspace ..... ENR 1.1 - 21

SIWL

- conversion graph ..... AD 1 - 50

SLOP

- procedures ..... ENR 2 - 4
- when communication failure ..... ENR 1.1 - 30

snow plan ..... AD 1 - 77

special alternate weather minima

- unavailability ..... ENR 1.5 - 21

special requirements flight

- general provisions ..... ENR 1.1 - 24
- ENR 1.1 - 68

special VFR

- class E airspace ..... ENR 1.2 - 1
- helicopter ..... ENR 1.2 - 1
- pilot responsibility ..... ENR 1.2 - 1
- visibility ..... ENR 1.2 - 1

specified pattern

- holding procedure ..... ENR 1.5 - 17

speed control

- arriving aircraft ..... ENR 1.6 - 3

speed variation

- descent profile ..... ENR 1.1 - 13

spot heights

- IAL limitations ..... ENR 1.5 - 2

squawk

- transponder requirement ..... ENR 1.6 - 5

SSR

- code change ..... ENR 1.6 - 5
- emergency codes ..... ENR 1.6 - 4
- flight notification entries ..... ENR 1.10 - 12
- Mode S operation ..... ENR 1.6 - 5
- transponder operating procedure ..... ENR 1.6 - 4

standard

- holding pattern ..... ENR 1.5 - 19

standard arrival routes

- see STAR

standard descent profile ..... ENR 1.1 - 13

standard instrument departures

- see SIDs

standard pattern

- threshold lights ..... AD 1 - 23
- threshold lights for ILS runways ..... AD 1 - 23

standard rate ..... ENR 1.7 - 5

standby power

- alternate requirement ..... ENR 1.1 - 53

STAR Procedures ..... ENR 1.5 - 26

state aircraft

- ATC priority assessment ..... ENR 1.4 - 11
- RVSM procedures ..... ENR 1.1 - 34



- step climb
  - rate of climb ..... ENR 1.7 - 5
- step-climb
  - application ..... ENR 1.7 - 4
  - procedure ..... ENR 1.7 - 4
- step-descent
  - procedure ..... ENR 1.7 - 4
  - rate of descent ..... ENR 1.7 - 5
- stop bar lights
  - description ..... AD 1 - 28
- stopway
  - lights ..... AD 1 - 26
  - markings ..... AD 1 - 11, AD 1 - 12
- straight-in approach
  - non-controlled aerodrome ..... ENR 1.1 - 45
- stream landing ..... ENR 1.1 - 17
- stream take-off ..... ENR 1.1 - 8
- strength of pavements ..... AD 1 - 41
- SURSIGHT
  - report by AP-3C Orion/P-8A Poseidon ..... ENR 1.1 - 64
- surveillance information service
  - non-controlled airspace ..... ENR 1.6 - 3
- survey operations
  - liaison with ATC ..... ENR 1.1 - 57

**T**

- TACAN
  - use in DME/GPS arrival ..... ENR 1.5 - 27
- tailwind
  - helicopter landing ..... ENR 1.1 - 60
  - helicopter take-off ..... ENR 1.1 - 59
- take-off
  - formation clearance ..... ENR 1.1 - 8
  - helicopters at night ..... ENR 1.1 - 59
  - separation within the formation ..... ENR 1.1 - 8
- take-off clearance
  - helicopter operations ..... ENR 1.1 - 59
- take-off path
  - helicopter operations ..... ENR 1.1 - 59
- taxi clearance
  - ATIS receipt ..... ENR 1.1 - 7
  - IFR flights ..... ENR 1.1 - 7
  - request ..... ENR 1.1 - 7
  - training flight ..... ENR 1.1 - 7
- taxiing
  - after landing ..... ENR 1.1 - 20
  - close to edges of pavements ..... AD 1 - 45
  - formation flight ..... ENR 1.1 - 7
  - frequency change after landing ..... ENR 1.1 - 21
  - helicopters at night ..... ENR 1.1 - 59
  - IFR at non-controlled aerodrome ..... ENR 1.1 - 40
  - maintaining a listening watch ..... ENR 1.1 - 21
  - right of way ..... ENR 1.1 - 3
  - taxi clearance ..... ENR 1.1 - 21
  - taxi instruction limit ..... ENR 1.1 - 20
- taxiway
  - aircraft no entry sign ..... AD 1 - 23
  - boundary marker intervals ..... AD 1 - 5
  - CAT II ILS runway ..... AD 1 - 22

centreline lights ..... AD 1 - 27

direction sign ..... AD 1 - 21

edge lighting ..... AD 1 - 27

edge markers and markings ..... AD 1 - 16

exit lights ..... AD 1 - 27

holding bay markings ..... AD 1 - 18

holding markers Cat I/II/III runways ..... AD 1 - 17

holding markings at intersections ..... AD 1 - 17

intersection markings diagram ..... AD 1 - 17

new holding position markings ..... AD 1 - 17

old holding position markings ..... AD 1 - 17

pavement-strength limit markings ..... AD 1 - 17

rapid-exit lights ..... AD 1 - 27

runway exit sign ..... AD 1 - 21

taxi guide-line markings ..... AD 1 - 16

taxi-holding position sign ..... AD 1 - 22

taxi-holding position sign at other locations ..... AD 1 - 23

termination ..... ENR 1.6 - 2

    vector ..... ENR 1.6 - 1

terminology ..... ENR 1.5 - 17

    holding procedures ..... ENR 1.5 - 17

terrain clearance ..... ENR 1.6 - 1

    vector ..... ENR 1.6 - 1

    VMC class E ..... ENR 1.1 - 21

terrain flight definition ..... ENR 1.1 - 1

threshold ..... AD 1 - 23

    lights ..... AD 1 - 24

    lights for temporary displacement ..... AD 1 - 24

    permanent lights ..... AD 1 - 23

    strobe lights ..... AD 1 - 23

tight turns ..... AD 1 - 45

time reference ..... ENR 1.1 - 22

    accuracy ..... ENR 1.1 - 22

timing ..... ENR 1.5 - 11

    compensation for wind effect ..... ENR 1.5 - 11

TMA ..... ENR 2 - 1

    description and publication details ..... ENR 2 - 1

tolerances ..... ENR 1.5 - 17

    approach procedures ..... ENR 1.5 - 17

    deviation from route or track ..... ENR 1.1 - 23

    track ..... ENR 1.1 - 22

touch-and-go landing ..... ENR 1.1 - 18

touchdown zone ..... AD 1 - 26

    lighting ..... AD 1 - 26

    lighting diagram ..... AD 1 - 26

towed object ..... ENR 1.1 - 1

    exemption ..... ENR 1.1 - 1

towing aircraft or objects ..... ENR 1.1 - 2

towing objects ..... ENR 1.1 - 3

track ..... ENR 1.1 - 22

    action to regain ..... ENR 1.1 - 22

    divergence notification ..... ENR 1.1 - 22

    LJR requirements ..... ENR 1.1 - 65

    track keeping tolerances ..... ENR 1.1 - 22

traffic information ..... ENR 1.6 - 3

    about unidentified aircraft ..... ENR 1.6 - 3

    AP-3C/P-8A in AEEZ ..... ENR 1.1 - 64

    Class E airspace ..... ENR 1.1 - 21

    LAHSO aircraft ..... ENR 1.1 - 33

    pilot responsibility ..... ENR 1.1 - 21

training flight  
     taxi clearance ..... ENR 1.1 - 7

transmission interval  
     vector ..... ENR 1.6 - 1

transponder  
     alerting/collision avoidance functions ..... ENR 1.6 - 4  
     altitude function ..... ENR 1.6 - 4  
     code read back ..... ENR 1.6 - 5  
     discrete code for SIS and CTA ..... ENR 1.6 - 5  
     inbound to Australia ..... ENR 1.6 - 5  
     loss of two way COM code selection ..... ENR 1.6 - 4  
     Mode S operating procedure ..... ENR 1.6 - 5  
     non-discrete code list ..... ENR 1.6 - 5  
     operating requirements ..... ENR 1.1 - 50  
     squawk requirement ..... ENR 1.6 - 5  
     SSR code change action ..... ENR 1.6 - 5  
     unlawful interference code selection ..... ENR 1.6 - 4

travel flights  
     flight notification requirements ..... ENR 1.10 - 2

triangle marking diagram ..... AD 1 - 19

turbo-jet aircraft  
     ground operation procedure ..... ENR 1.1 - 56

turning nodes ..... AD 1 - 45

turns  
     holding procedures ..... ENR 1.5 - 17

T-VASIS  
     approach slope guidance ..... AD 1 - 33  
     fog ..... AD 1 - 33  
     intensity ..... AD 1 - 33  
     lights ..... AD 1 - 33  
     night azimuth ..... AD 1 - 33  
     PAPI comparison ..... AD 1 - 36  
     signal diagrams ..... AD 1 - 34

tyre pressure  
     conversion graph ..... AD 1 - 50  
     maximum ..... AD 1 - 42  
     operations above maximum ..... AD 1 - 41  
     permanent concession graph ..... AD 1 - 43

**U**

UAV  
     aircraft identification ..... ENR 1.10 - 10

unidentified aircraft  
     ATC responsibility CTA ..... ENR 1.6 - 3  
     traffic information format ..... ENR 1.6 - 3

unlawful interference  
     ATC responsibility ..... ENR 1.6 - 4  
     ATS action ..... ENR 1.13 - 1  
     pilot action ..... ENR 1.13 - 1

unmanned aerial vehicle  
     aircraft identification ..... ENR 1.10 - 10

unrated pavement  
     aircraft gross mass ..... AD 1 - 45  
     aircraft suitability graph ..... AD 1 - 45  
     strength ..... AD 1 - 45  
     tyre pressure ..... AD 1 - 45

unserviceable movement area  
     lights ..... AD 1 - 26

upper ATS routes publication details ..... ENR 3 - 1

**V**

VAA-H  
 descent below MDA requirements ..... ENR 1.5 - 4  
 description ..... ENR 1.5 - 4  
 missed approach ..... ENR 1.5 - 7

VASIS  
 activation criteria ..... AD 1 - 37  
 obstacle clearance ..... AD 1 - 33  
 publication details ..... AD 1 - 37  
 types ..... AD 1 - 33

VAT  
 definition ..... ENR 1.5 - 1

vector  
 aircraft directional instruments unreliable ..... ENR 1.6 - 1  
 arriving aircraft manoeuvring ..... ENR 1.6 - 1  
 ATC transmission interval ..... ENR 1.6 - 1  
 established on final report ..... ENR 1.6 - 2  
 final approach ..... ENR 1.6 - 1  
 heading requirement after take-off ..... ENR 1.6 - 1  
 in VMC by day ..... ENR 1.6 - 1  
 intercept for final procedure ..... ENR 1.6 - 2  
 off established route ..... ENR 1.6 - 1  
 pilot action ..... ENR 1.6 - 1  
 pilot advice when terminated ..... ENR 1.6 - 2  
 pilot-interpreted approach ..... ENR 1.6 - 1  
 position advice to pilots ..... ENR 1.6 - 1  
 position information format ..... ENR 1.6 - 2  
 selection of vector ..... ENR 1.6 - 1  
 termination ..... ENR 1.6 - 2  
 terrain clearance ..... ENR 1.6 - 1

vertical separation  
 military CTA no radar ..... ENR 1.4 - 7

VFR  
 aircraft captain's responsibility ..... ENR 1.1 - 24  
 alternate at night ..... ENR 1.1 - 53  
 alternate minima ..... ENR 1.1 - 52  
 altimeter requirement ..... ENR 1.7 - 1  
 altimeter requirements above FL200 ..... ENR 1.7 - 1  
 avoidance of IFR holding patterns ..... ENR 1.1 - 21  
 cruising levels table north of 80°S ..... ENR 1.7 - 5  
 cruising levels table south of 80°s ..... ENR 1.7 - 6  
 flight conditions ..... ENR 1.1 - 22  
 flight notification requirements ..... ENR 1.10 - 2  
 helicopter alternate minima ..... ENR 1.1 - 52  
 military flight notification requirements ..... ENR 1.10 - 3  
 night flying restrictions ..... ENR 1.2 - 1  
 on top of cloud ..... ENR 1.1 - 22  
 pilot responsibility for alternate ..... ENR 1.1 - 51  
 reporting schedule ..... ENR 1.10 - 3  
 SARTIME details required ..... ENR 1.10 - 3  
 SARTIME nomination ..... ENR 1.10 - 2  
 visual approach ..... ENR 1.1 - 14

VFR altimeters ..... ENR 1.7 - 1

VFR flights  
 flight notification ..... ENR 1.1 - 7

VFR on top  
 Class E airspace ..... ENR 1.1 - 11  
 IFR ..... ENR 1.1 - 11

VHF  
 radio telephony OCTA ..... ENR 1.1 - 49

VHF aircraft  
 alternate criteria ..... ENR 1.1 - 54

VIP  
 separation standards ..... ENR 1.4 - 7

visual  
 clearance ..... ENR 1.1 - 15  
 report by day ..... ENR 1.1 - 15

visual approach  
 criteria ..... ENR 1.1 - 14, ENR 1.5 - 7  
 IFR ..... ENR 1.1 - 14  
 VFR flight ..... ENR 1.1 - 14

visual circling  
 missed approach procedure ..... ENR 1.5 - 6

visual departure  
 ATC responsibility ..... ENR 1.1 - 9  
 criteria ..... ENR 1.1 - 9  
 IFR flight ..... ENR 1.1 - 9  
 VMC ..... ENR 1.1 - 9

visual docking guidance system  
 APIS ..... AD 1 - 38  
 description ..... AD 1 - 37  
 safeguard system ..... AD 1 - 39

visual meteorological conditions (VMC) ..... ENR 1.2 - 2

visual navigation ..... ENR 1.1 - 22

visual position fixing ..... ENR 1.1 - 22

visual reference  
 navigation by ..... ENR 1.1 - 22

visual segment  
 missed approach ..... ENR 1.5 - 7

VMC  
 terrain clearance class E ..... ENR 1.1 - 21  
 visual departure ..... ENR 1.1 - 9

volcanic activity  
 pilot responsibility ..... ENR 1.1 - 56

**W**

wake turbulence separation  
 for landing ..... ENR 1.1 - 17  
 pilot responsibility ..... ENR 1.4 - 6

waypoint  
 publication details ..... ENR 4 - 1

weather conditions  
 alternate ..... ENR 1.1 - 51

well clear ..... ENR 1.1 - 2

wind allowance  
 holding procedures ..... ENR 1.5 - 17

wind effect  
 heading / timing compensation ..... ENR 1.5 - 11

wind indicator  
 colour ..... AD 1 - 37  
 lights ..... AD 1 - 32  
 location ..... AD 1 - 37  
 minimum number at aerodrome ..... AD 1 - 37  
 primary ..... AD 1 - 37

wind shear  
 NAPS ..... ENR 1.5 - 25





# FIHA - AREA OF COVERAGE

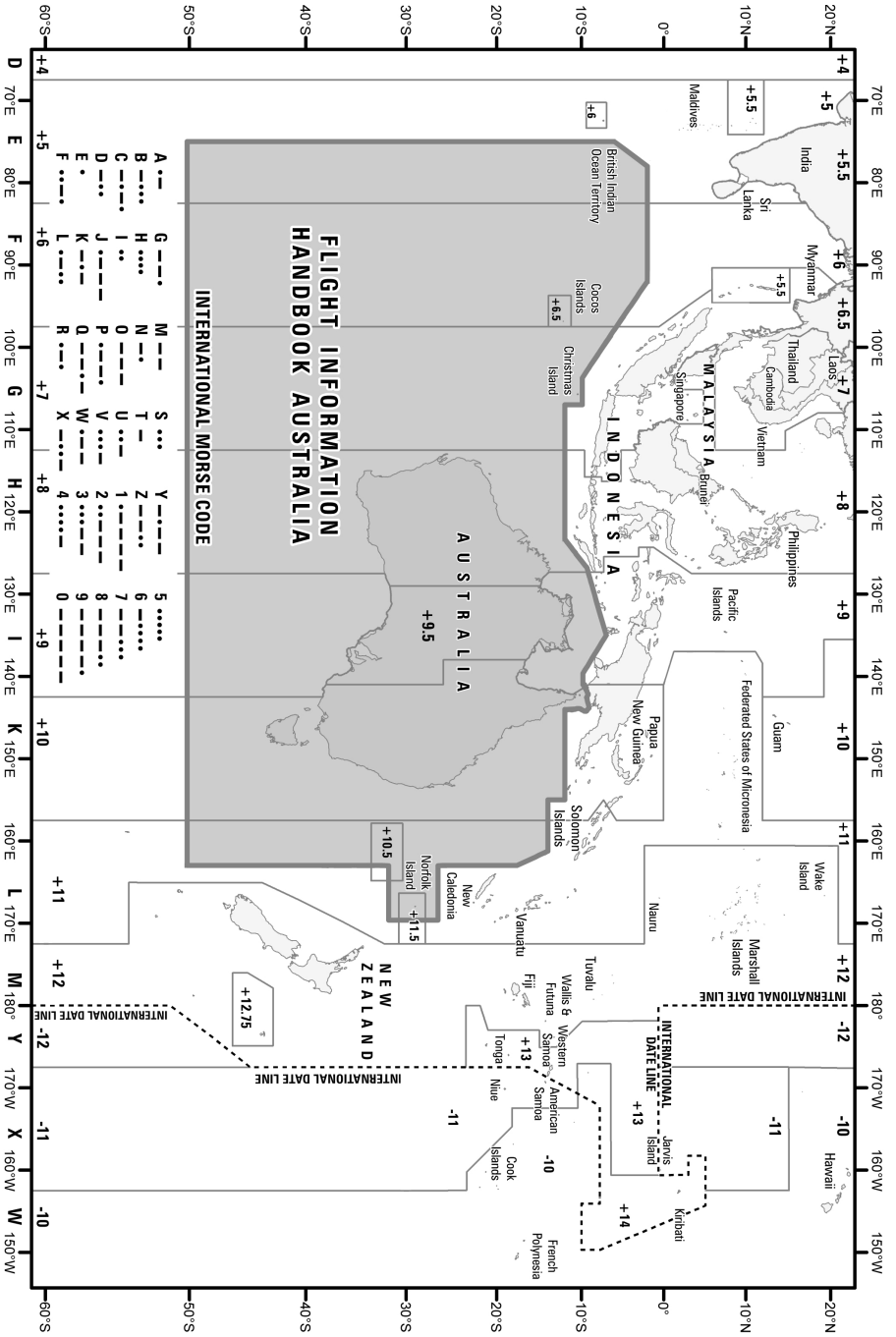

# FIHA - AREA OF COVERAGE