

**AUSTRALIAN DEFENCE FORCE
FLIGHT INFORMATION PUBLICATION
(PLANNING)**



**GENERAL PLANNING
AUSTRALIA**

Effective: **20 MAR 25**

Next Issue: **12 JUN 25**

WARNING

Consult AsA SUP/AIC and NOTAM for latest information





© Commonwealth of Australia 2025

This work is copyright. Apart from any use as permitted under the *Copyright Act 1968*, no part may be reproduced by any process without prior written permission from the Commonwealth. Requests and inquiries concerning reproduction and rights should be addressed to the Commonwealth Copyright Administration, Attorney General's Department, National Circuit, Barton ACT 2600 or posted at <http://www.ag.gov.au/> copyright. Alternatively, contact the Department of Defence, AIS-AF, VBM-M-2, Victoria Barracks, St Kilda Road, Southbank VIC 3006 or mail your request/inquiry to: Department of Defence, AIS-AF, GPO Box 393, VBM-M-2, Melbourne VIC 3001.

SUMMARY OF NOTEWORTHY AMENDMENTS

Note 1: This summary does not necessarily include all details of the amendment and should not be substituted for reading the amended text.

Note 2: Not all amendments are included in this summary - only those amendments considered noteworthy.

Airservices is working towards the introduction of an electronic Aeronautical Information Publication (eAIP) to align, as far as practicable, with ICAO specifications. Content that is no longer current, duplicated, of an informative rather than instructional nature or contained in other documents (such as legislation, guides or websites), is being removed from the AIP and consequently GPA.

AIP content that is owned by CASA refers to legislation and guidance material that is being amended WEF 02 December 2021. The AIP will be aligned with these changes, which includes multiple references to CASA guidance material that will not be available after 02 December, resulting in extensive deletion or replacement and involves significant paragraph re-numbering.

20 MAR 25

Two letter designators. Operators with two letter designators to use a numerical suffix of at least two numbers. *GEN 3.4 para 5.15.3*

Phraseology. Take-off when not in association with a runway clearance or instruction. *GEN 3.4 para 6.16.3.*



GEN 0.1 PREFACE

1. NAME OF PUBLISHING AUTHORITY

1.1 GPA is issued by AIS-AF under the authority of the Defence Aviation Authority (Defence AA).

2. APPLICABLE DOCUMENTS

2.1 GPA is prepared in accordance with the Standards and Recommended Practices of the following ICAO documents:

- a. Facilitation - Annex 9
- b. Aerodromes - Annex 14
- c. Aeronautical Information Services - Annex 15
- d. Aeronautical Information Services Manual (Doc 8126-AN/872)
- e. Aeronautical Charts - Annex 4
- f. Aeronautical Chart Manual (Doc 8697-AN/889/2)

3. ADF AIP - DOCUMENTS INVOLVED

3.1 ADF AIP is designed to be used as a complete package and component documents (including GPA) and charts should not be used without reference to other applicable components of the package.

3.2 **CASA Publications Applicability.** References to Civil Aviation Safety Authority Airworthiness Circulars (AC), Civil Aviation Advisory Publications (CAAP) or Manuals of Standards (MOS) direct the user to explanatory information and airmanship considerations associated with the related rules and procedures. Military and State aviation operations are not bound by civil regulation, however, these publications augment knowledge and understanding of the intended outcomes when conducting those operations. AC, CAAP or MOS information do not override authorised military OIP.

4. LAYOUT

4.1 **Purpose.** The purpose of GPA is to consolidate important planning, procedures and regulatory information of a lasting nature, relevant to ADF flying operations, for aircrew and support personnel. As a component of ADF AIP, GPA contains that information which aircrew will require access to both during flight planning and in flight. It is produced in a bound A5 format suitable for both cockpit and desktop use.

4.2 The rules of the air and air traffic control procedures are, to the extent practicable, incorporated into the main text of GPA in plain language.

4.3 Rules of Interpretation.

- a. 'must' is used in the imperative sense. Use of other commonly used imperatives such as 'shall', 'is to' or 'will' should not occur.
- b. 'shall' is analogous to the word must.
- c. 'may' is used in the permissive sense to state authority or permission to do the act described, and the words 'no person may...' or 'a person may not' mean that no person is required, authorised or permitted to do the act described.
- d. 'should' is used to imply an act or process identified for inclusion in a desired outcome is complied with, unless sound reasoning may determine otherwise.

4.4 Various requirements of GPA may be over-riden by appropriately authorised orders and instructions by commanders.

4.5 **Heading Prefixes.** The heading prefixes ADF, ARMY, RAAF and RAN are added to sections, paragraphs and notes to identify where ADF/ARMY/RAAF/RAN aeronautical procedures differ from Australian civil aviation rules of the air. Minor textual differences are not identified. The term ADF identifies procedures applicable to all three Services. Heading prefixes and their associated subjects are listed in the Index.

5. ORDERING PUBLICATIONS AND AMENDMENT SERVICES

5.1 Publications can be obtained via Unit PUBSO by sending an email to ais.af@defence.gov.au. Details should include:

- a. User code (if known)
- b. Contact name
- c. Contact details
- d. Delivery address
- e. Product requested
- f. Quantity
- g. Date required

5.2 Verbal product orders will be accepted under exceptional circumstances by calling the AIS-AF Distribution Coordinator on +61 3 8531 6667.

5.3 Requests for amendments to procedures contained within GPA are to be forwarded to the AIS-AF Air Liaison Officer through the originator's Wing Aviation Safety Officer (WASO) or equivalent. Requests for amendment should be submitted on a Publication Improvement Report and Reply form (AO011), available via Web Forms at <http://intranet.defence.gov.au>. The originating authority must ensure that all necessary information has been included and is correct in detail.

5.4 **Customer Change of Address.** All customers shall promptly advise AIS-AF of any change of address.

5.5 Mail returned "Address Unknown" suspends the address record of the subscriber, and no further mail will be forwarded until advice is received of an address change.

6. NOTIFICATION TO USERS OF AMENDMENTS



6.1 Product is amended by NOTAM and Aircservices AIP SUP, and is produced in accordance with the AIS-AF Production Schedule available on the AIS-AF website (DRN only).

6.2 Any rescheduling of the above will be notified, in certain circumstances, by NOTAM.

6.3 Significant changes are indicated by a vertical black line (change bar) and deletions have a "D" added to the vertical line. Amendments to Table of Contents or Index are not identified by change bars.

7. QUERIES ABOUT DOCUMENTATION

7.1 Contact with AIS-AF is generally to be via Unit AIO/PUBSO/NAVO during working hours (0800 - 1630h AEST, MON-FRI), to the following appointments:

- | | | | |
|---------------------|--------------------------|---|-----------------|
| a. Distribution | Distribution Coordinator |  | +61 3 8531 6667 |
| b. Technical advice | Air Liaison Officer |  | +61 3 8531 6362 |
| | | MOB | +61 412 814 225 |

7.2 Written feedback can be submitted via email to ais.af@defence.gov.au or using the online General Customer Feedback survey available on the AIS-AF website (DRN only).

7.3 All e-mail requests are to be forwarded to ais.af@defence.gov.au and marked for the attention of the relevant appointment.

7.4 All urgent after-hours requests are to be directed to the duty officer +61 412 814 225. As AIS-AF does not maintain a formal after-hours capability, the majority of requests will be dealt with on the next working day. Urgent operational matters will be dealt with in as timely a manner as possible.

8. NON STANDARD PRODUCT REQUESTS

8.1 All requests for products outside the published AIS-AF Production and Delivery Schedule should be discussed with the AIS-AF Air Liaison Officer. This may result in a recommendation to submit a formal request via e-mail ais.af@defence.gov.au. Please ensure sufficient lead time (minimum 6 to 8 weeks) is allowed for customised AI products to be designed and published.

GEN 0.2 RECORD OF AMENDMENTS

1. GPA consists only of a complete book, therefore no record of amendments is required.

GEN 0.3 RECORD OF AIP SUPPLEMENTS

1. This section from Airservices Australia AIP not applicable to ADF.

2. DEFENCE AERODROMES NOT CERTIFIED OR REGISTERED:

The following applies to non-certified and unregistered Defence aerodromes:

- a. No active obstacle management;
- b. May not be subject to regular technical inspections;
- c. Do not receive a regular aerodrome NOTAM service. Refer to Head Office NOTAMs for updates on Instrument Flight Procedures.
- d. Prior to commencing a flight, a pilot or operator **MUST** contact the Aerodrome Operator or Responsible Authority to check currency of aerodrome information.
- e. Additional information is included in the Notes section of the Instrument Flight Procedures chart.
- f. Instrument Flight Procedures are designed to ICAO PANSOPS and CASA MOS Part 173 standards but are not compliant with airfield survey data quality requirements. An additional 360FT is added to Instrument Approach safety heights to account for unknown vertical obstructions. It is the responsibility of the pilot to determine suitability of the facility and to avoid obstacles in the Visual Segment of the procedure below the minimum descent altitude.
- g. Instrument Flight Procedures for non-certified aerodromes will permit flight to a promulgated minima in Instrument Meteorological Conditions. Flight below circling height is to be IAW relevant OIP.

GEN 0.4 CHECKLIST OF PAGES

1. GPA consists only of a complete book, therefore no checklist of pages is required.

GEN 0.5 LIST OF HAND AMENDMENTS

1. GPA consists only of a complete book, therefore no hand amendments are required.

GEN 0.6 TABLE OF CONTENTS

GEN 0.1 PREFACE	GEN 0 - 1
GEN 0.2 RECORD OF AMENDMENTS	GEN 0 - 3
GEN 0.3 RECORD OF AIP SUPPLEMENTS	GEN 0 - 3
GEN 0.4 CHECKLIST OF PAGES	GEN 0 - 3
GEN 0.5 LIST OF HAND AMENDMENTS	GEN 0 - 3
GEN 0.6 TABLE OF CONTENTS	GEN 0 - 4
GEN 1.1 DESIGNATED AUTHORITIES	GEN 1.1 - 1
DESIGNATED AUTHORITIES	GEN 1.1 - 1
GEN 1.2 ENTRY, TRANSIT AND DEPARTURE OF AIRCRAFT	GEN 1.2 - 1
ENTRY, TRANSIT AND DEPARTURE OF INTERNATIONAL FLIGHTS	GEN 1.2 - 1
Preamble	GEN 1.2 - 1
Scheduled International Commercial Services by Foreign Aircraft of Contracting States to the Chicago Convention	GEN 1.2 - 1
Summary of Documents to be presented by Aircraft Captain or Authorised Agent	GEN 1.2 - 1
Non-Scheduled International Commercial Services by Foreign Aircraft of Contracting States to the Chicago Convention	GEN 1.2 - 3
Non-Scheduled International Commercial Services by Australian Aircraft	GEN 1.2 - 3
Non-Scheduled International Commercial Services by Australian Non-Contracting States and Contracting States which do not Require Prior Approval - Department of Infrastructure only	GEN 1.2 - 3
International Flights by Foreign Aircraft not Possessing Nationality of Contracting State to the Chicago Convention	GEN 1.2 - 3
Flights by Foreign State Aircraft	GEN 1.2 - 3
International Private Flights	GEN 1.2 - 5
Aviation Security	GEN 1.2 - 5
Aviation Security: Transport Security Program Requirements	GEN 1.2 - 5
Carriage of Munitions of War and Implements of War	GEN 1.2 - 5
Foreign Clearances - Australian Aircraft	GEN 1.2 - 5
Aircraft on International Flights to Comply with Laws	GEN 1.2 - 6
Section 22 of the Civil Aviation Act 1988	GEN 1.2 - 6
Aircraft: Noise Operating Restrictions	GEN 1.2 - 6
Air Carriers' Liability and Insurance	GEN 1.2 - 6
Australian Operational Documents Available to Pilots Licensed by Another State Proposing to Visit Australia	GEN 1.2 - 6
DESIGNATED INTERNATIONAL AIRPORTS - AUSTRALIA	GEN 1.2 - 6
Major International Airports	GEN 1.2 - 6
Restricted Use International Airports	GEN 1.2 - 7
Alternate Airports to International Airports	GEN 1.2 - 8
International Non-Scheduled Flight Airports	GEN 1.2 - 8
External Territory International Airport	GEN 1.2 - 9
ADF Military Bases	GEN 1.2 - 9
GEN 1.3 ENTRY, TRANSIT AND DEPARTURE OF PASSENGERS AND CREW	GEN 1.3 - 1
INTRODUCTION	GEN 1.3 - 1
BIOSECURITY REQUIREMENTS	GEN 1.3 - 1
General	GEN 1.3 - 1
Disinsection	GEN 1.3 - 1
Pre-arrival Reporting (PAR) Requirements	GEN 1.3 - 2
Ill Passengers or Death On Board	GEN 1.3 - 2
Pratique	GEN 1.3 - 3
Biosecurity Waste	GEN 1.3 - 3
Biosecurity In-Flight Announcement	GEN 1.3 - 4
Required Vaccination and Health Documents	GEN 1.3 - 4

Biosecurity screening of baggage	GEN 1.3 - 4
Conditionally Non-prohibited Goods	GEN 1.3 - 4
IMMIGRATION/EMIGRATION REQUIREMENTS	GEN 1.3 - 5
General	GEN 1.3 - 5
Advance Passenger Processing (APP) Reporting of Passengers and Crew	GEN 1.3 - 5
Inwards Clearance - Passports or Other Travel Document	GEN 1.3 - 5
Visa Requirements	GEN 1.3 - 6
Returning Non-citizen Permanent Residents of Australia	GEN 1.3 - 9
Incoming Passenger Cards	GEN 1.3 - 9
Inward Clearance - Documentation	GEN 1.3 - 9
Outwards Clearance - Documentation	GEN 1.3 - 10
CUSTOMS REQUIREMENTS	GEN 1.3 - 10
Inward Clearance - Documentation	GEN 1.3 - 10
Examination of Crew and Passengers - Arrivals	GEN 1.3 - 10
Outward Clearance - Documentation	GEN 1.3 - 10
Examination of Crew and Passengers – Departures	GEN 1.3 - 11
TRANSIT PASSENGERS - CLEARANCE REQUIREMENTS AND PROCEDURES WITHIN AUSTRALIA	GEN 1.3 - 11
Immigration Requirements	GEN 1.3 - 11
Customs and Biosecurity Requirements	GEN 1.3 - 11
Requirements for the Airline Representative	GEN 1.3 - 11
LANDINGS AT DESIGNATED ALTERNATE AIRPORTS OR ELSEWHERE THAN AT DESIGNATED INTERNATIONAL AIRPORTS WITHIN AUSTRALIA	GEN 1.3 - 12
General	GEN 1.3 - 12
Designated Alternate Airports to International Airports	GEN 1.3 - 12
Landing made other than at a Designated Alternate Airport	GEN 1.3 - 13
CHARTER FLIGHTS - GUIDELINES FOR CLEARANCE	GEN 1.3 - 14
DESIGNATED INTERNATIONAL AIRPORTS - AUSTRALIAN EXTERNAL TERRITORIES - ENTRY AND DEPARTURE REQUIREMENTS AND PROCEDURES	GEN 1.3 - 14
Biosecurity Requirements for External Territories	GEN 1.3 - 14
External Territory International Airports	GEN 1.3 - 14
Territory of Christmas Island	GEN 1.3 - 14
Territory of Cocos (Keeling) Islands	GEN 1.3 - 15
Territory of Norfolk Island	GEN 1.3 - 15
ADF - DEFENCE LOGISTICS MANUALS (DEFLOGMAN)	GEN 1.3 - 16
Defence Compliance with Australian Biosecurity Measures	GEN 1.3 - 16
Destruction of Insect Procedures for Aircraft	GEN 1.3 - 16
Passenger/Cargo Cabin Disinsection	GEN 1.3 - 16
Cargo Hold Disinsection	GEN 1.3 - 17
International Flights Arriving at Military Airfields	GEN 1.3 - 17
Military Working Dogs	GEN 1.3 - 18
Military Working Dogs - Biosecurity	GEN 1.3 - 18
Control of Foodstuffs and Food Waste	GEN 1.3 - 18
Quarantinable Disease	GEN 1.3 - 18
GEN 1.4 ENTRY, TRANSIT AND DEPARTURE OF CARGO	GEN 1.4 - 1
CUSTOMS REQUIREMENTS CONCERNING CARGO AND OTHER ARTICLES	GEN 1.4 - 1
Cargo Report	GEN 1.4 - 1
List of Stores (e.g. narcotic drugs, beer, wine, spirits and tobacco products)	GEN 1.4 - 1
Import Declarations and Carnets	GEN 1.4 - 1
Treatment of Diplomatic and Consular Goods	GEN 1.4 - 1
Departure Report	GEN 1.4 - 2
Outwards Manifest	GEN 1.4 - 2
Export Reporting	GEN 1.4 - 2
Certificate of Clearance	GEN 1.4 - 2
BIOSECURITY REQUIREMENTS	GEN 1.4 - 3
AIR CARGO SECURITY REQUIREMENTS	GEN 1.4 - 3

ADF - AUSTRALIAN DEFENCE FORCE CARGO	GEN 1.4 - 4
Returned, Used ADF Owned Equipment	GEN 1.4 - 4
Personal Effects	GEN 1.4 - 4
Outwards Cargo	GEN 1.4 - 4
ADF - FOREIGN MILITARY CARGO	GEN 1.4 - 4
GEN 1.5 AIRCRAFT INSTRUMENTS, EQUIPMENT AND DOCUMENTATION	GEN 1.5 - 1
RADIO COMMUNICATION SYSTEM REQUIREMENTS	GEN 1.5 - 1
RADIO NAVIGATION SYSTEM REQUIREMENTS	GEN 1.5 - 1
EMERGENCY LOCATOR TRANSMITTER (ELT)	GEN 1.5 - 1
AIRBORNE WEATHER RADAR	GEN 1.5 - 1
GROUND PROXIMITY WARNING SYSTEM (GPWS)	GEN 1.5 - 1
SURVEILLANCE EQUIPMENT	GEN 1.5 - 2
General requirements and capabilities	GEN 1.5 - 2
Flight without serviceable required surveillance equipment.	GEN 1.5 - 2
ADS-B equipment in State Aircraft	GEN 1.5 - 2
AIRBORNE COLLISION AVOIDANCE SYSTEM (ACAS) /	
TRAFFIC ALERT AND COLLISION AVOIDANCE SYSTEM (TCAS)	GEN 1.5 - 3
Overview	GEN 1.5 - 3
Use of ACAS/TCAS Indicators	GEN 1.5 - 3
Responsibility for Separation	GEN 1.5 - 3
ADF - ACAS/TCAS Operation and Reporting	GEN 1.5 - 3
High Vertical Rate (HVR) Encounters	GEN 1.5 - 4
AREA NAVIGATION SYSTEMS APPROVAL AND OPERATIONS	GEN 1.5 - 4
Notification of Failure or Operation Outside of Tolerance	GEN 1.5 - 4
RVSM APPROVAL AND OPERATIONS	GEN 1.5 - 4
AOC TO BE CARRIED ON BOARD	GEN 1.5 - 4
GEN 1.6 SUMMARY OF NATIONAL REGULATIONS AND	
INTERNATIONAL AGREEMENT/CONVENTIONS	GEN 1.6 - 1
GEN 1.7 DIFFERENCES FROM ICAO STANDARDS, RECOMMENDED	
PRACTICES AND PROCEDURES	GEN 1.7 - 1
GEN 2.1 MEASURING SYSTEM, AIRCRAFT MARKINGS, HOLIDAYS	GEN 2.1 - 1
UNITS OF MEASUREMENT	GEN 2.1 - 1
TIME SYSTEM	GEN 2.1 - 1
GEODETIC REFERENCE DATUM	GEN 2.1 - 1
PUBLIC HOLIDAYS	GEN 2.1 - 2
ARMY - AIRCRAFT MARKINGS	GEN 2.1 - 2
GEN 2.2 DEFINITIONS AND ABBREVIATIONS	GEN 2.2 - 1
DEFINITIONS	GEN 2.2 - 1
GENERAL AND METEOROLOGICAL ABBREVIATIONS	GEN 2.2 - 28
GEN 2.3 CHART SYMBOLS	GEN 2.3 - 1
GEN 2.4 LOCATION INDICATORS	GEN 2.4 - 1
CODE ALLOCATION	GEN 2.4 - 1
LIST OF CODES	GEN 2.4 - 1
GEN 2.5 RADIO NAVIGATION AIDS	GEN 2.5 - 1
GEN 2.6 CONVERSION OF UNITS OF MEASUREMENT	GEN 2.6 - 1
FUEL WEIGHT TABLES	GEN 2.6 - 1
GENERAL CONVERSIONS	GEN 2.6 - 2
DECIMAL MINUTES OF AN ARC TO SECONDS OF AN ARC	GEN 2.6 - 3
SECONDS OF AN ARC TO DECIMAL MINUTES OF AN ARC	GEN 2.6 - 4
WIND COMPONENT	GEN 2.6 - 5
GEN 2.7 FIRST LIGHT AND LAST LIGHT COMPUTATIONS	GEN 2.7 - 1
CONVERSION OF ARC TO TIME	GEN 2.7 - 2

GEN 3.1 AERONAUTICAL INFORMATION SERVICES	GEN 3.1 - 1
ADF - AERONAUTICAL AUTHORITY	GEN 3.1 - 1
ADF - AERONAUTICAL INFORMATION SERVICE	GEN 3.1 - 1
ADF - PUBLISHED AERONAUTICAL INFORMATION	GEN 3.1 - 1
General	GEN 3.1 - 1
Aeronautical Information Publication (AIP) Australia	GEN 3.1 - 1
Amendment Service to the AIP (AIP AMDT)	GEN 3.1 - 2
Supplement to the AIP (AIP SUP)	GEN 3.1 - 2
NOTAM	GEN 3.1 - 2
AIRAC SYSTEM	GEN 3.1 - 3
ADF - PREFLIGHT INFORMATION SERVICE	GEN 3.1 - 4
DIGITAL DATA SETS	GEN 3.1 - 4
GEN 3.2 AERONAUTICAL CHARTS	GEN 3.2 - 1
CHART SERIES	GEN 3.2 - 1
Aeronautical Chart Series Available	GEN 3.2 - 1
General description of each series	GEN 3.2 - 1
GEN 3.3 AIR TRAFFIC SERVICES	GEN 3.3 - 1
RESPONSIBLE SERVICE	GEN 3.3 - 1
AREA OF RESPONSIBILITY	GEN 3.3 - 1
TYPES OF SERVICE	GEN 3.3 - 1
General	GEN 3.3 - 1
Air Traffic Control Service	GEN 3.3 - 2
Flight Information Service (FIS)	GEN 3.3 - 2
CALCULATION OF LOWEST SAFE ALTITUDE (LSALT)	GEN 3.3 - 4
Pilot Responsibilities	GEN 3.3 - 4
ADF - Helicopter Destination Safety Height	GEN 3.3 - 5
Explanatory Figures	GEN 3.3 - 6
CONTINGENCY PROCEDURES - AIR TRAFFIC SERVICES	
TEMPORARILY NOT AVAILABLE	GEN 3.3 - 12
Introduction	GEN 3.3 - 12
CONTROL OF VEHICULAR AND	
PEDESTRIAN MOVEMENT ON AERODROMES	GEN 3.3 - 12
GEN 3.4 COMMUNICATION SERVICES	GEN 3.4 - 1
AREA OF RESPONSIBILITY	GEN 3.4 - 1
RADIO NAVIGATION SERVICE	GEN 3.4 - 1
General	GEN 3.4 - 1
Identification	GEN 3.4 - 2
Non-Directional Beacon (NDB)	GEN 3.4 - 2
VHF Omni-Directional Radio Range (VOR)	GEN 3.4 - 2
Distance Measuring Equipment (DME)	GEN 3.4 - 2
Tactical Air Navigation Aid (TACAN)	GEN 3.4 - 2
Public Broadcasting Stations	GEN 3.4 - 2
Abnormal Operation of Radio Navigation Aids	GEN 3.4 - 2
Remote Facilities	GEN 3.4 - 3
Monitoring of Identifier	GEN 3.4 - 3
Global Navigation Satellite System (GNSS)	GEN 3.4 - 3
Global Positioning System (GPS)	GEN 3.4 - 3
COMMUNICATION SERVICES	GEN 3.4 - 3
Radio Frequencies	GEN 3.4 - 3
Certified Air/Ground Radio Service (CA/GRS)	GEN 3.4 - 4
UNICOM	GEN 3.4 - 5
Aerodrome Frequency Response Unit	GEN 3.4 - 5
Aeronautical Fixed Telecommunication Network	GEN 3.4 - 6
Special Broadcast Services	GEN 3.4 - 6
Aeronautical Codes	GEN 3.4 - 6
RADIO TELEPHONY PROCEDURES	GEN 3.4 - 6
Introduction	GEN 3.4 - 6
General	GEN 3.4 - 6
Transmission Format	GEN 3.4 - 7
Readback Requirements	GEN 3.4 - 7
Conditional Clearances	GEN 3.4 - 7
Route Terminology	GEN 3.4 - 8

Amended Route or Level	GEN 3.4 - 8
Language	GEN 3.4 - 8
Phonetic Alphabet	GEN 3.4 - 8
Pronunciation of numbers	GEN 3.4 - 9
Transmission of Numbers	GEN 3.4 - 9
Ground Station Callsigns	GEN 3.4 - 11
Aircraft Callsigns	GEN 3.4 - 11
Flight Number Callsigns - Using Group Form	GEN 3.4 - 12
Selection of Aircraft Identification Numbers and Suffixes	GEN 3.4 - 12
Ground Vehicles	GEN 3.4 - 12
Interchange and Leased Aircraft	GEN 3.4 - 12
Unmanned Aerial Vehicles	GEN 3.4 - 13
Callsigns - Full and Abbreviated Formats	GEN 3.4 - 13
Registration of Radiotelephony Designators	GEN 3.4 - 14
Callsigns - Special Task Operations	GEN 3.4 - 14
PHRASEOLOGIES	GEN 3.4 - 15
Standard Words and Phrases	GEN 3.4 - 15
Emergency	GEN 3.4 - 17
Traffic Alert and Collision Avoidance System (TCAS), Safety Alerts and Avoiding Action and Wind Shear Escape	GEN 3.4 - 18
Status of Restricted Areas and Military Operating Areas	GEN 3.4 - 20
SARWATCH	GEN 3.4 - 20
General Phrases	GEN 3.4 - 21
Frequency Management	GEN 3.4 - 24
Traffic Information	GEN 3.4 - 25
Meteorological Information	GEN 3.4 - 26
Reports and Information	GEN 3.4 - 27
Clearances	GEN 3.4 - 29
SID	GEN 3.4 - 32
STAR	GEN 3.4 - 34
Approach and Area Control Services	GEN 3.4 - 36
Phraseologies to be used related to CPDLC	GEN 3.4 - 38
Vicinity of Aerodrome	GEN 3.4 - 38
ATS Surveillance Service Phraseologies	GEN 3.4 - 50
ATS DATA LINK SERVICES	GEN 3.4 - 57
General	GEN 3.4 - 57
Pilot Responsibilities	GEN 3.4 - 57
Controller Pilot Data Link Communication (CPDLC)	GEN 3.4 - 58
Logon Procedures	GEN 3.4 - 59
Position Reporting Requirements	GEN 3.4 - 60
CPDLC Level Reporting Following Change of Level	GEN 3.4 - 60
Reporting Back on Route by CPDLC	GEN 3.4 - 60
Block Level Clearances	GEN 3.4 - 61
Revision of Estimates Using CPDLC	GEN 3.4 - 61
CPDLC Message Restrictions	GEN 3.4 - 61
CPDLC CONTACT and MONITOR messages	GEN 3.4 - 61
CPDLC route clearances	GEN 3.4 - 61
CPDLC Failure	GEN 3.4 - 61
Notification Of Emergency	GEN 3.4 - 62
CPDLC Message Set	GEN 3.4 - 63
GENERAL	GEN 3.4 - 67
CABLE OPERATIONS	GEN 3.4 - 72
ROTARY WING AND VTOL AIRCRAFT	GEN 3.4 - 72

GEN 3.5 METEOROLOGICAL SERVICES	GEN 3.5 - 1
ADF - METEOROLOGICAL AUTHORITY	GEN 3.5 - 1
AREA OF RESPONSIBILITY	GEN 3.5 - 1
METEOROLOGICAL OBSERVATIONS AND REPORTS	GEN 3.5 - 2
TYPES OF SERVICES	GEN 3.5 - 2
ATS Meteorological Information Service	GEN 3.5 - 3
Interpretation and Use of Forecasts	GEN 3.5 - 4
Forecasts for Operations Above 10,000FT	GEN 3.5 - 5
Significant Weather (SIGWX) Charts	GEN 3.5 - 5
Route Sector Winds and Temperatures (RSWT)	GEN 3.5 - 5
Grid Point Wind and Temperature (GPWT) Forecasts	GEN 3.5 - 5
Graphical Area Forecasts (GAF) for Operations At or Below 10,000FT	GEN 3.5 - 6
Aerodrome Forecasts (TAF)	GEN 3.5 - 7
Airport Weather Briefings (AWB)	GEN 3.5 - 7
Wind Shear Warnings	GEN 3.5 - 8
Volcanic Ash Advisories (VAA)	GEN 3.5 - 9
Space Weather (SWX)	GEN 3.5 - 9
Tropical Cyclones (TC)	GEN 3.5 - 10
NOTIFICATION REQUIRED FROM OPERATORS	GEN 3.5 - 10
For International Operations	GEN 3.5 - 10
For Domestic Operations	GEN 3.5 - 10
Forecasts for Flights - Valid GAF not Available	GEN 3.5 - 10
AIRCRAFT REPORTS	GEN 3.5 - 11
Routine Aircraft Observations	GEN 3.5 - 11
AIREP Special	GEN 3.5 - 11
Wind Shear - Reporting	GEN 3.5 - 11
Volcanic Activity Reports	GEN 3.5 - 12
VOLMET SERVICE	GEN 3.5 - 12
SIGMET AND AIRMET SERVICES	GEN 3.5 - 17
SIGMET	GEN 3.5 - 17
AIRMET	GEN 3.5 - 18
OTHER AUTOMATED METEOROLOGICAL SERVICES	GEN 3.5 - 18
Aerodrome Weather Information Service (AWIS) and Weather and Terminal Information Reciter (WATIR)	GEN 3.5 - 18
Introduction	GEN 3.5 - 19
Mean Equivalent Wind Table (Dec-May)	GEN 3.5 - 20
Mean Equivalent Wind Table (Jun-Nov)	GEN 3.5 - 34
GEN 3.6 SEARCH AND RESCUE	GEN 3.6 - 1
PURPOSE	GEN 3.6 - 1
RESPONSIBLE AUTHORITIES	GEN 3.6 - 1
ORGANISATION	GEN 3.6 - 1
ADF - RESCUE COORDINATION CENTRES	GEN 3.6 - 1
EMERGENCY ALERTING PROCEDURES	GEN 3.6 - 2
Pilot Notification	GEN 3.6 - 2
Advice to Aircraft Operators	GEN 3.6 - 2
In-Flight Emergency Response Action	GEN 3.6 - 2
Medical Emergency	GEN 3.6 - 3
Participation In Searches	GEN 3.6 - 3
EMERGENCY LOCATOR TRANSMITTER (ELT)	GEN 3.6 - 3
COSPAS-SARSAT	GEN 3.6 - 4
SEARCH AND RESCUE TRANSPONDER (SART)	GEN 3.6 - 4
SAR ACTION	GEN 3.6 - 4
SRR BOUNDARY	GEN 3.6 - 5
ADF - SAR AGREEMENTS	GEN 3.6 - 5
Provision for Entry of Foreign Aircraft	GEN 3.6 - 5
Foreign Civil Aircraft	GEN 3.6 - 5
Foreign State Aircraft	GEN 3.6 - 5
Aircraft of Non-Contracting States	GEN 3.6 - 6
Airports	GEN 3.6 - 6

ADF - ADF SAR ORGANISATION	GEN 3.6 - 6
Unit Responsibilities	GEN 3.6 - 6
Callsigns	GEN 3.6 - 7
Publicity	GEN 3.6 - 7
Distress Frequencies	GEN 3.6 - 7
Civilian SAR	GEN 3.6 - 8
Communications	GEN 3.6 - 8
Reports	GEN 3.6 - 8
Conditions of Availability	GEN 3.6 - 8
GEN 4.1 AERODROME/HELIPORT CHARGES	GEN 4 - 1
LANDING CHARGES	GEN 4 - 1
PASSENGER MOVEMENT CHARGE	GEN 4 - 1
GEN 4.2 AIR NAVIGATION SERVICES CHARGES	GEN 4 - 1
INDEX	INDEX 1 - 1
GPA - AREA OF COVERAGE	1 - 2

GEN 1.1 DESIGNATED AUTHORITIES**1. DESIGNATED AUTHORITIES****1.1 Department of Infrastructure, Transport, Regional Development and Communications and the Arts (Department of Infrastructure)****a. Facilitation and aviation policy:**

Assistant Secretary
COVID Aviation Reforms Branch
Aviation and Airports Group
Department of Infrastructure, Transport, Regional Development and Communications and the Arts
GPO Box 594
CANBERRA ACT 2601
AUSTRALIA
☎ +61 2 6274 7760
E-mail: internationalaviation@infrastructure.gov.au

b. Aircraft noise operating restrictions:

First Assistant Secretary - COVID Aviation Response Programs Division
Aviation and Airports Group
Department of Infrastructure, Transport, Regional Development and Communications and the Arts
GPO Box 594
CANBERRA ACT 2601 AUSTRALIA
☎ +61 2 6274 7892
Email: aircraftpermits@infrastructure.gov.au

1.2 Department of Home Affairs:

a. Aviation Security
First Assistant Secretary
Cyber and Infrastructure Security Operations Division
Department of Home Affairs
GPO Box 25
BELCONNEN ACT 2616 AUSTRALIA
☎ +61 2 6195 9584
Email: national.coordinator@homeaffairs.gov.au

b. Cyber and Infrastructure Security Operations Division
Transport Security Incident Reporting
☎ 1300 791 581 (Option 0)
☎ +61 2 5127 8995 (outside Australia)
E-mail: transport.security@homeaffairs.gov.au

c. Cyber and Infrastructure Security Operations Division
Transport Security Guidance and Enquiries
☎ +61 2 5127 8991 (Option 1)
E-mail: guidancecentre@homeaffairs.gov.au

d. Cyber and Infrastructure Security Operations Division
Transport Security Applications (e.g. Transport Security Programs) -
Regulatory Assessment Operations
GPO Box 25
BELCONNEN ACT 2616 AUSTRALIA
Email: national.coordinator@homeaffairs.gov.au

1.3 Australian Border Force

- a. Director - Traveller Policy Section
Australian Border Force
GPO Box 25
BELCONNEN ACT 2616 AUSTRALIA
☎ +61 2 5127 7133
Email: travellerpolicy@abf.gov.au

1.4 Civil Aviation Safety Authority

- a. *Head Office:*
Civil Aviation Safety Authority
GPO Box 2005
CANBERRA ACT 2601 AUSTRALIA
☎ 131 757 (within Australia)
☎ +61 2 6217 1449 (from overseas)
Web: <https://www.casa.gov.au>
- b. *International Operations:*
International Operations
GPO Box 2005
CANBERRA ACT 2601 AUSTRALIA
☎ +61 7 3144 7400
FAX: +61 7 3144 7555
E-mail: international_ops@casa.gov.au
Web: <https://www.casa.gov.au/standard-page/foreign-air-transport-operators-certificate>
or
<https://www.casa.gov.au/standard-page/non-scheduled-flight-permission>

1.5 Air Traffic Services

Chief Executive Officer - Airservices Australia
Alan Woods Building
25 Constitution Avenue
CANBERRA CITY ACT 2601, or
PO Box 367
CANBERRA ACT 2601
☎ +61 2 6268 4111
FAX: +61 2 6268 5693

1.6 Department of Agriculture, Fisheries and Forestry (DAFF)-Biosecurity

Director - Conveyances and Ports Section
Department of Agriculture, Fisheries and Forestry (DAFF)
GPO Box 858
CANBERRA ACT 2601
☎ +61 2 6272 3901
E-mail: arrivals@awe.gov.au
Web: www.agriculture.gov.au/biosecurity/avm/aircraft

1.7 Department of Health and Aged Care - Human Biosecurity

Director - Border Health Section
Emergency Management Division
Chief Medical Office Group
Department of Health and Aged Care
GPO Box 9848
CANBERRA ACT 2601
☎ 1800 020 103
(after hours emergency number +61 2 6289 3030)
E-mail: humanbiosecurity@health.gov.au
Web: www.health.gov.au/humanbiosecurity

1.8 Aircraft Accident Investigation

Australian Transport Safety Bureau (ATSB)
PO Box 321
CANBERRA ACT 2601
☎ 1800 011 034
+61 2 6122 1602
E-mail: atsbinfo@atsb.gov.au
Web: www.atsb.gov.au

1.9 Meteorology

The Director
Bureau of Meteorology
700 Collins St
DOCKLANDS VIC 3001
or
GPO Box 1289
MELBOURNE VIC 3001
☎ +61 3 9669 4000
FAX +61 3 9669 4699
Web: www.bom.gov.au

1.10 Search and Rescue

- a. Australian Maritime Safety Authority (AMSA)
GPO Box 2181
CANBERRA ACT 2601
Email enquiries: www.amsa.gov.au/about/contact-us
Web: www.amsa.gov.au
- b. For Search and Rescue General Enquiries:
☎ 1800 627 484
+61 2 6279 5000
- c. For the Australian Joint Rescue Coordination Centre (JRCC):
☎ 1800 815 257
+61 2 6230 6899

1.11 Department of Defence

- a. Chief of Air Force
Department of Defence
Building R1, Russell Offices
RUSSELL ACT 2600
- b. Chief of Joint Operations
HQ Joint Operations Command
Department of Defence
PO Box 7928
CANBERRA BC ACT 2610
- c. Diplomatic Clearance Authorisation Cell
PH: +61 2 6128 4819
Email enquiries: dipa.hqac@defence.gov.au

GEN 1.2 ENTRY, TRANSIT AND DEPARTURE OF AIRCRAFT

1. ENTRY, TRANSIT AND DEPARTURE OF INTERNATIONAL FLIGHTS

1.1 Preamble

1.1.1 All flights into, from, or over Australian territory, and landings in such territory must be carried out in accordance with the legislation of Australia regarding civil aviation. This includes obtaining separate approvals pertaining to air safety, aviation security, aircraft licencing and landing permits, border and biosecurity controls from a number of independent Australian Government Departments detailed in section *GEN 1.1*, including:

- a. The Department of Home Affairs.
- b. The Civil Aviation Safety Authority (CASA).
- c. The Department of Infrastructure.
- d. The Department of Agriculture, Water and the Environment.

1.1.2 In accordance with *Section 10 of the Air Navigation Act, 1920*, aircraft arriving in or departing from any part of Australian territory must land at and depart from airports designated for that purpose.

1.1.3 The Customs Act 1901 (s58(1)) and the Migration Act 1958 (s247) also require that aircraft arriving into Australian territory from overseas must arrive at an airport appointed under the Customs Act. Information on airports for entry and departure are shown in *GEN 1.2 Section 2* and *GEN 1.3 Section 8*.

1.1.4 Aircraft which are completely cleared by the Australian Border Force (ABF) at a designated international airport are permitted to land at other airports within Australian territory. Nevertheless, when such aircraft depart from Australian territory, they can only do so from a designated international airport.

1.1.5 Aircraft that are not fully cleared by Department of Agriculture, Fisheries and Forestry (DAFF) - Biosecurity and formally released from biosecurity control, at their first airport of call, continue to be subject to biosecurity control and restrictions for their movements to other locations, until released.

1.2 Scheduled International Commercial Services by Foreign Aircraft of Contracting States to the Chicago Convention

1.2.1 This section from Airservices Australia AIP not applicable to ADF.

1.3 Summary of Documents to be presented by Aircraft Captain or Authorised Agent

Note: All required documents must be furnished in English, and originals and all copies must be completely legible. Names should be shown in block letters, and with regard to names of passengers, initials at least are to be inserted. Documents must be fully and accurately completed.

1.3.1 At First Airport of Call in Australia

a. Impending Arrival Report

The aircraft operator must report the impending arrival of the aircraft to the Australian Border Force, regardless of whether or not the aircraft is carrying cargo. If the aircraft is carrying cargo, the Impending Arrival Report must be lodged electronically in the Integrated Cargo System (ICS):

- 1) not more than 10 days before the estimated time of arrival of the aircraft, and:
 - i no later than three hours before the estimated time of arrival of the aircraft if the flight from the airport is likely to take not less than three hours; or
 - ii one hour if the flight from the airport is likely to take less than three hours.

If the aircraft is not carrying cargo, the Impending Arrival Report may be lodged either electronically in the

ICS, or by document (Form B364) available online: www.abf.gov.au/form-listing/forms/b364.pdf, within the above time frames.

b. Actual Arrival Report

The aircraft operator must report the particulars of the arrival of the aircraft and the time of arrival to the Australian Border Force. Where an aircraft is carrying cargo, the Actual Arrival Report must be lodged electronically in the ICS within three hours of the arrival of the aircraft or before the certificate of clearance is issued, whichever occurs first.

If the aircraft is not carrying cargo, the Actual Arrival Report may be lodged electronically in the ICS, or by Form B358, available online: www.abf.gov.au/form-listing/forms/b358.pdf, providing the reporter satisfies an Evidence of Identity and the form is signed in the manner specified on the form.

The Actual Arrival Report in ICS is made in place of a General Declaration. However, some countries still require General Declarations for arriving aircraft. ABF Officers will stamp the General Declaration on departure of the aircraft in these circumstances.

Note: ABF officers may still require a General Declaration be produced as part of general mandatory disclosures.

c. List of Stores and Prohibited Goods (e.g. narcotic drugs, beer, wine, spirits and tobacco products)

The aircraft operator must report the particulars of the aircraft stores and of any prohibited goods contained in those stores within the same timeframe as the Actual Arrival Report to Australian Border Force. A report may be made using form B367, available online: www.abf.gov.au/form-listing/forms/b367.pdf. See *GEN 1.4 para 1.2* for more information.

d. Cargo Report

The cargo report is used to report the particulars of all cargo (including mail, in-transit and transshipment cargo) on board an aircraft. The carrier is required to report the full detail of cargo, including any cargo carried on behalf of another cargo reporter to the Australian Border Force and the details of the depot operator who will first receive the cargo after it has been unloaded from the aircraft at a place in Australia. Private charter flights which are carrying cargo (air freight) are not exempt from these requirements. See *GEN 1.4 para 1.1* for more information.

e. Crew Declaration – One copy per crew member

Each individual crew member must complete a copy of Crew Declaration Form B465, available online: <https://www.abf.gov.au/form-listing/forms/b465.pdf>.

1.3.2 At Airports other than First Airport of Call in Australia

The requirements for the following reports are the same as those outlined in *para 1.3.1*.

- a. Impending Arrival Report;
- b. Actual Arrival Report;
- c. List of Stores and Prohibited Goods (e.g. narcotic drugs, beer, wine, spirits and tobacco products).

Further, at stops other than the first airport of call, the aircraft captain or authorised agent will present the copy of the Certificate of Clearance signed and stamped by the ABF Officer prior to departure from the previous stop.

If the aircraft is due to arrive at its first airport of call since its last departure airport outside Australia, the pilot or authorised agent must report to the Australian Border Force, in accordance with this section, particulars of all cargo:

- a. The aircraft captain or the authorised agent has arranged to be carried on the aircraft on the flight; and
- b. that is intended to be unloaded from the aircraft at an airport in Australia (whether the first airport or any subsequent airport on the same flight).

1.3.3 At First Airport of Departure from Australia

a. **Export Permits (where required)**

Note: One copy of the General Declaration must be signed and one copy of each manifest initialled by the aircraft captain or authorised agent.

- b. **List of Stores that are prohibited narcotic drugs** – See *GEN 1.4 para 1.2*.
- c. **Departure Report** – The departure report is a prerequisite that must be satisfied before a certificate of clearance can be granted by the Australian Border Force (ABF). See *GEN 1.4 para 1.5*.
- d. **Outwards (Main) Manifest (electronic, lodged in the ICS)** – The outwards manifest is used to notify the Australian Border Force of all goods that were loaded on board the aircraft. See *GEN 1.4 para 1.6*.

If a departing aircraft is not carrying any export cargo, a manifest must still be lodged. This manifest states that no cargo was loaded and is called a 'Nil Manifest'.

- e. **Certificate of Clearance** – The pilot of an aircraft must not depart from any airport without receiving a signed and stamped Certificate of Clearance in respect to the aircraft from an ABF Officer.

1.4 Non-Scheduled International Commercial Services by Foreign Aircraft of Contracting States to the Chicago Convention

1.4.1 This section from Airservices Australia AIP not applicable to ADF.

1.5 Non-Scheduled International Commercial Services by Australian Aircraft

1.5.1 This section from Airservices Australia AIP not applicable to ADF.

1.6 Non-Scheduled International Commercial Services by Australian Non-Contracting States and Contracting States which do not Require Prior Approval - Department of Infrastructure only

1.6.1 This section from Airservices Australia AIP not applicable to ADF.

1.7 International Flights by Foreign Aircraft not Possessing Nationality of Contracting State to the Chicago Convention

1.7.1 This section from Airservices Australia AIP not applicable to ADF.

1.8 Flights by Foreign State Aircraft

1.8.1 Aircraft Diplomatic Clearance Application. Diplomatic clearance is required for foreign state aircraft to enter and operate in Australian territory, including the airspace above Australian offshore islands. Applications for foreign state aircraft to conduct flying operations within Australian territory must be submitted at least five working days before the proposed date of entry into Australian airspace.

At least two weeks' notice is required if military services are requested (such as parking at a Royal Australian Air Force base). A separate application must be submitted for each aircraft. The Department of Foreign Affairs web pages provide aircraft diplomatic clearance application forms and instructions, at:

www.dfat.gov.au/about-us/foreign-embassies/protocol/Pages/diplomatic-clearances-aircraft-and-ships

1.8.2 Applications are submitted by completing the application form and emailing it to: dipa.hqac@defence.gov.au. Diplomatic clearance applicants will be required to provide the following information:

- a. Requesting Country;
- b. Point of Contact details;
- c. Purpose of the flight;
- d. Aircraft Operator (if civil registered, the address and nationality);
- e. Aircraft Type;
- f. Aircraft Registration Mark;
- g. Aircraft Call-sign;
- h. Itinerary (including previous and next destinations);
- i. Flight Routes;
- j. Aircraft Captain Details;
- k. Crew and Passenger Numbers;
- l. VIP Details (if applicable);
- m. Weapons Details;
- n. Dangerous Cargo Details;
- o. Ground Handling Details (for aircraft landing at Defence Establishments); and
- p. Ground Handling Agent (for aircraft landing at Civilian Airfields).

1.8.3 In the event of any changes to the flight details, the request must be updated and be resent as soon as possible to: dipa.hqac@defence.gov.au.

1.8.4 Any questions relating to diplomatic clearances should be addressed to the Diplomatic Clearance Authorisation Cell on +61 2 6128 4819 or dipa.hqac@defence.gov.au.

1.8.5 **Compliance.** Foreign State aircraft operating under diplomatic clearance are required to comply with applicable aerodrome procedures and air traffic control directions.

1.8.5.1 Diplomatic clearance does not exempt the requesting government's responsibility to meet other Australian Government requirements such as customs, biosecurity and immigration or the requirement for permission to carry or import munitions or implements of war. It is the responsibility of the foreign government to ensure all necessary paperwork and/or clearances from Australian Government agencies are arranged prior to arrival.

1.8.5.2 A regulation 136 permission from the Australian Civil Aviation Safety Authority (CASA) is also required. In certain circumstances, diplomatic clearance may only be issued subject to the aircraft, cargo and passengers undertaking additional checks and searches. Failure to comply with any conditions on a diplomatic clearance, or with other government agencies' procedures, could result in penalties and affect issuance of future diplomatic clearances.

1.8.6 **Foreign Military Aircraft Participating in Exercises within Australia.** Foreign State aircraft visiting Australia for a combined exercise are required to seek diplomatic clearance and CASA permission for their transit to and from their operating location. All exercise flights are covered under the exercise arrangements. However, any transits from their deployed location to another location outside the exercise schedule will require approval. Certain military aircraft will require permission to import from the Australian Border Force. Export permission from the Department of Defence may also be required.

1.8.7 **Alternate Routes and In-flight Emergencies.** Approval will not be issued for alternate or diversion airfield requests inside Australia. Aircraft diverting in response to an in-flight emergency or poor weather do not require diplomatic approval and should select the nearest appropriate airfield. Notification of any emergency diversions should be sent to the Diplomatic Clearance Cell at the earliest opportunity thereafter landing (dipa.hqac@defence.gov.au).

1.9 International Private Flights

1.9.1 This section from Airservices Australia AIP not applicable to ADF.

1.10 Aviation Security

1.10.1 **ADF** - Under the Aviation Transport Security Regulations 2005 there is a requirement to carry and display an Aviation Security Identification Card (ASIC) at security controlled civil aerodromes. The Aviation Transport Security Regulations (Part 3 regulation 3.06) exempts members of the ADF and certain visiting forces from the requirement to carry and display an ASIC in a secure area, provided the following conditions are met:

- a. The person is a member of the Australian Defence Force (ADF); or a visiting force (within the meaning of the Defence (Visiting Forces) Act 1963) on training, exercises or operations with the ADF;
- b. The member:
 - 1) is on duty and involved:
 - i in the operation of an aircraft; or
 - ii in supporting the operation of an aircraft; and
 - 2) is in uniform or other role appropriate clothing; and
 - 3) displays proper identification as a member of a defence force.

1.11 Aviation Security: Transport Security Program Requirements

1.11.1 This section from Airservices Australia AIP not applicable to ADF.

1.12 Carriage of Munitions of War and Implements of War

1.12.1 In accordance with *Section 19(2) of the Air Navigation Act 1920*, munitions of war or implements of war must not be carried by an aircraft in or over Australian territory, or by an Australian aircraft outside Australian territory, except with the permission in writing of the delegate of the Minister for Infrastructure, Transport and Regional Development.

1.12.2 Applications for transportation of munitions of war by State aircraft of a country other than Australia in Australian territory, or by an Australian aircraft outside Australian territory should be lodged with the Chief of Air Force or Chief of Joint Operations, Department of Defence (see *GEN 1.1*).

1.12.3 Applications for carriage of munitions of war or implements of war in all other circumstances should be lodged with the Secretary of the Department of Infrastructure, through the Assistant Secretary Aviation Industry Policy, Aviation and Airports Division (see *GEN 1.1*).

1.12.4 Certain firearms and weapons will require permission to import from the Australian Border Force, the Attorney-General's Department, or state/territory police - depending on the firearm or weapon type and intended use in Australia. Export permission from the Department of Defence may also be required.

1.13 Foreign Clearances - Australian Aircraft

1.13.1 Australian aircraft operators are responsible for obtaining foreign clearances when necessary for overflights of, or landings in, the territory of another State.

1.13.2 For guidance on this process, contact the Diplomatic Clearance Officer, Department of Defence via email at: dipa.hqac@defence.gov.au

1.13.3 Pilots are advised that their flight plans will not be considered by some countries unless documentation of onward foreign clearance is produced.

1.14 Aircraft on International Flights to Comply with Laws

1.14.1 The owner, operator, hirer, aircraft captain and any other pilot of any aircraft granted a licence, permission or approval that enters or departs Australian territory must comply with the provisions of all applicable laws of the Commonwealth or of a State or Territory. This includes laws relating to entry and departure or clearance of passengers, crew and/or cargo, immigration, passports, customs and biosecurity. See *Section 16 of the Air Navigation Act 1920* for more information.

1.15 Section 22 of the Civil Aviation Act 1988

1.15.1 This section from Airservices Australia AIP not applicable to ADF.

1.16 Aircraft: Noise Operating Restrictions

1.16.1 This section from Airservices Australia AIP not applicable to ADF.

1.17 Air Carriers' Liability and Insurance

1.17.1 This section from Airservices Australia AIP not applicable to ADF.

1.18 Australian Operational Documents Available to Pilots Licensed by Another State Proposing to Visit Australia

1.18.1 **ADF** - AIS-AF is able to provide ADF AIP and Airservices Australia AIP documents to visiting foreign military aircrew.

1.18.2 Requests for these documents should be forwarded through their parent Service's channels to the address detailed at GEN 0.1 [Section 5](#) Additional information which should be provided includes the nature of the intended operation and the duration of the requirement. Failure to provide this additional information will delay processing of the request.

2. DESIGNATED INTERNATIONAL AIRPORTS - AUSTRALIA

Note: Operations by aircraft at all of the airports listed in the following section are limited to the pavement strength shown against the airport in AIP ERSa. Prior application must be made to the airport operator for a pavement concession where this is necessary.

2.1 Major International Airports

2.1.1 "Major International Airport" means an airport of entry and departure for international air traffic where there is an ongoing border agency presence to conduct all formalities incident to Customs, immigration and biosecurity clearance.

Airport	Clearances Available
Adelaide	Customs, immigration and biosecurity.
Brisbane	Customs, immigration and biosecurity.
Cairns	Customs, immigration and biosecurity.
Darwin	Customs, immigration and biosecurity.
Melbourne	Customs, immigration and biosecurity.
Perth	Customs, immigration and biosecurity.
Sydney	Customs, immigration and biosecurity.

Note: Reasonable notification required for non-scheduled traffic. Mandatory biosecurity reporting requirements apply to all non-scheduled flights landing in Australian Territory.

2.2 Restricted Use International Airports

2.2.1 "Restricted Use International Airport" means an airport of entry and departure at which the formalities incident to Customs, immigration, and biosecurity and similar procedures are made available on a restricted basis, to coincide with flights with prior approval only.

2.2.2 Restricted Use International Airports are:

- a. Avalon
- b. Brisbane West Wellcamp

*Note: A First Port of Entry for biosecurity for overseas freighter aircraft **only** and goods carried on a freighter aircraft, except live horses. All other aircraft require prior DAFF - Biosecurity approval to land.*

- c. Broome
- d. Canberra
- e. Coffs Harbour

Note: Coffs Harbour is not determined as a first port of entry for overseas aircraft - requires prior DAFF - Biosecurity approval to land.

- f. Gold Coast

Note: Although not categorised as a major international airport, Gold Coast Airport has an ongoing border agency presence to conduct customs, immigration and biosecurity clearances.

- g. Hobart
- h. Learmonth

Note: Learmonth is a determined first point of entry for biosecurity for overseas aircraft, but goods are not permitted to be unloaded - requires prior DAFF - Biosecurity approval.

- i. Lord Howe Island

Note: Lord Howe Island is not determined as a biosecurity first point of entry for overseas aircraft - requires prior DAFF - Biosecurity approval to land.

- j. Port Hedland
- k. Sunshine Coast
- l. Townsville
- m. Williamtown/Newcastle

2.2.3 The airline or its agent/representatives may be responsible for covering additional expenses relating to the positioning of resources from another border agency base to a Restricted Use International Airport.

2.3 Alternate Airports to International Airports

2.3.1 “Alternate Airport” means an airport specified in the flight plan to which a flight may proceed when it becomes inadvisable to land at the airport of intended landing (see also *GEN 1.3 para 6.*).

2.3.2 The Airline or its agent/representatives may be responsible for covering additional expenses relating to the positioning of resources from another border agency base to an Alternate Airport.

2.3.3 The following designated airports have customs, immigration and biosecurity clearances available if reasonable notification of diversion is given:

- a. Canberra

Note: May be nominated as an International alternate subject to first obtaining Canberra Airport consent. Canberra Airport may require a separate agreement as capacity is limited.

- b. Gold Coast

- c. Port Hedland

- d. Townsville - may be nominated as an international alternate for wide bodied aircraft subject to the following conditions:
 - Use of the military apron will be subject to the requirements of the RAAF.
 - Taxiway “K” may be used when the military apron is not available.

2.3.4 In the event of emergency/distress, an aircraft engaged in an international flight may land at the following alternate airports:

- a. Alice Springs
- b. Avalon
- c. Busselton Margaret River
- d. Coffs Harbour
- e. Geraldton
- f. Kalgoorlie
- g. Launceston
- h. Learmonth
- i. Rockhampton
- j. Tindal

When safe to do so, the aircraft is then required to proceed directly on to a designated international airport where customs, immigration and biosecurity clearances can be completed. Further information is at *GEN 1.3 Section 6.*

2.4 International Non-Scheduled Flight Airports

2.4.1 An “International Non-scheduled Flight Airport” is an airport where approval may be granted, for international non-scheduled flights only, if the prescribed notice is provided in advance. No other international operations are permitted.

Horn Island

Customs, immigration and biosecurity clearances are available if reasonable prior notice is given.

2.5 External Territory International Airport

2.5.1 “External Territory International Airport” means an airport of entry and departure for international air traffic located upon an Australian External Territory, where all formalities incident to Immigration, Biosecurity and Territory Customs, and similar procedures are available.

2.5.2 Australian external territory international airports are as follows:

- a. Christmas Island
- b. Cocos (Keeling) Islands
- c. Norfolk Island

2.5.3 At these airports, customs, immigration and biosecurity clearance services are provided to coincide with approved flights only.

2.6 ADF Military Bases

2.6.1 The following ADF Bases are available for use by ADF and foreign military aircraft, subject to 48 hours prior notice to Customs as detailed below.

Airport	Clearances Available
RAAF Amberley	Customs, immigration and biosecurity (contact Customs at Brisbane Airport).
RAAF Darwin	Customs, immigration and biosecurity (contact Customs at Darwin).
Defence Establishment Fairbairn	Customs, immigration and biosecurity (contact Customs Canberra).
RAAF East Sale	Customs, immigration and biosecurity (contact Customs at Melbourne Airport).
RAAF Edinburgh	Customs, immigration and biosecurity (contact Customs at Adelaide Airport).
NAS Nowra	Customs, immigration and biosecurity (contact Customs at Port Kembla).
RAAF Pearce	Customs, immigration and biosecurity (contact Customs at Perth Airport).
RAAF Richmond	Customs, immigration and biosecurity (contact Customs at Richmond).
RAAF Scherger	Customs, immigration and biosecurity (prior approval of Customs and Biosecurity services required except in an emergency).
RAAF Tindal	Customs, immigration and biosecurity (contact Customs at Darwin for prior permission).
RAAF Williamtown	Customs, immigration and biosecurity (contact Customs at Newcastle).



GEN 1.3 ENTRY, TRANSIT AND DEPARTURE OF PASSENGERS AND CREW

1. INTRODUCTION

1.1 Travellers and aircrew need to ensure they understand and are fully compliant with all relevant requirements for travel to Australia.

The two stages of examination of passengers:

- a. biosecurity processing, and
- b. customs and immigration processing.

1.2 Standard procedures have been designed to facilitate the clearance of passengers through the two stages of examination.

2. BIOSECURITY REQUIREMENTS

2.1 General

2.1.1 Australia is free from many diseases, pests and weeds which cause serious damage in other parts of the world. Air crew and passengers are required to comply with legislative requirements under the *Biosecurity Act 2015*.

2.1.2 Detailed information about the biosecurity requirements for overseas aircraft can be found on the Department of Agriculture, Fisheries and Forestry website at: www.agriculture.gov.au/biosecurity/avm/aircraft/

2.2 Disinsection

2.2.1 All aircraft are required to meet Australia's disinsection requirements. The operator of an overseas aircraft will make arrangements for the disinsection of the aircraft in a manner, and within a time, approved by the Director of Human Biosecurity.

2.2.2 The following disinsection options are available to airline operators to meet Australia's cabin and hold disinsection requirements:

Method	Cabin Chemicals	Hold Chemicals
Residual	2% permethrin	2% permethrin
Pre-embarkation	Pre-flight - 2% permethrin	1 shot - 2% permethrin and 2% d-phenothrin
*Pre-departure method	Pre-departure - 2% d-phenothrin or 1R-trans-phenothrin 2%	1 shot - containing d-phenothrin 2% or 1R-trans-phenothrin 2% and permethrin 2%
On-arrival	2% d-phenothrin	1 shot - 2% permethrin and 2% d-phenothrin

*Note: * The World Health Organization (WHO) no longer recommends the 'pre-flight and top-of-descent' aircraft disinsection method. This method is no longer an approved method for aircraft arrivals into Australia and may be replaced by the 'pre-departure' method or one of the other approved methods listed above. Aircraft operators intending to arrive in Australia should check the Department of Agriculture, Fisheries and Forestry (DAFF) website to confirm the availability of disinsection options, www.agriculture.gov.au/biosecurity/avm/aircraft/disinsection, or contact biosecurity officials at the intended arrival airport.*

2.2.3 The Residual and Pre-embarkation methods can only be used when an Approved Arrangement with the DAFF or a Compliance Agreement with the Ministry for Primary Industries, New Zealand (MPI) has been administered.

2.2.4 The '*Schedule of aircraft disinsection procedures for flights into Australia and New Zealand*' has been prepared in cooperation between the DAFF and the MPI. Further information is available at: www.agriculture.gov.au/biosecurity/avm/aircraft/disinsection

2.2.5 If an aircraft has not completed the required disinsection measures prior to arrival, a pre-arrival report must be given stating that fact - see sections 2.3 and 2.5.

2.3 Pre-arrival Reporting (PAR) Requirements.

2.3.1 Prior to arrival at a first point of entry in Australia, the operator of an international aircraft is required to advise the DAFF - Biosecurity of the following:

- a. Details of any person on board the aircraft who has, or has had signs and symptoms of a listed human disease during the flight (see *section 2.4*);
- b. Details of any person on board the aircraft who died during the flight;
- c. If there are animals or plants (or both) in the cabin of the aircraft;
- d. If any animal died in the cabin of the aircraft during the flight - that fact; and
- e. If the aircraft is an incoming aircraft and the prescribed disinsection measures for the aircraft have not been taken, or will not have been taken, before the aircraft arrives at its first landing place in Australian territory.

Note: The report may be delivered through an airline authorised representative at the arrival airport. However it remains the liability of the aircraft operator to ensure any such reports are delivered to a biosecurity officer.

2.3.2 The operator, or commander of the aircraft on a non-scheduled flight must also report the following additional information without exception:

- a. Information identifying the aircraft;
- b. The intended first landing place of the aircraft in Australian territory;
- c. The estimated day and time of arrival of the aircraft;
- d. The name and contact details of;
 - 1) the operator of the aircraft; and
 - 2) if the operator is not the owner of the aircraft
- e. Details about any animals or plants in the cabin of the aircraft.

Note: The report may be delivered through an airline authorised representative at the arrival airport. However it remains the liability of the aircraft operator to ensure any such reports are delivered to a biosecurity officer.

2.3.3 The pre-arrival report must be given:

- a. at the earlier of;
 - 1) as close to the top of descent as is operationally practicable before the aircraft is estimated to arrive at its first landing place in Australian territory; and
 - 2) 30 minutes before the aircraft is estimated to come to standstill after arriving at its first landing place in Australian territory; or
- b. at the time specified by a biosecurity official.

Note: The commander of an aircraft on a non-scheduled flights may provide the additional information to the DAFF - Biosecurity prior to the departure of the aircraft from the last port before entering Australian territory.

2.3.4 The pre-arrival report must be made to biosecurity officers located at the intended first landing place (or the department office responsible for the biosecurity clearances at the intended first landing place) either orally or in writing (including electronically).

2.3.5 After this information is reported, if the Commander becomes aware the information is incomplete or incorrect they will provide additional information or correct the information as soon as practicable.

2.4 III Passengers or Death On Board

2.4.1 Any traveller showing signs of a listed Human Disease or a serious illness and needing medical assistance must be reported to a biosecurity officer in a pre-arrival report (see *section 2.3*). Commanders are required to report any changes to this status that occur after submitting the pre-arrival report.

2.4.2 The operator of the aircraft is responsible for requesting medical or ambulance services.

2.4.3 Any of the following are considered possible signs or symptoms of a Listed Human Disease (LHD) or reportable illness:

- a. fever or suspected fever;
- b. jaundice;
- c. a new rash;
- d. unusual bleeding;
- e. a new coughing illness; and
- f. any illness that required prompt medical assistance.

2.4.4 If there is any doubt whether an ill traveller needs to be reported, the Commander should contact a biosecurity officer. Commanders do not need to report travellers whose illness is a result of:

- a. drug or alcohol use;
- b. an injury or a pre-existing physical condition; or
- c. motion sickness.
- d. Commanders are not required to report a traveller who has a pre-arranged medical transfer prior to boarding the flight.

2.4.5 The operator of an aircraft is legally responsible for ensuring the DAFF - Biosecurity is notified. Failure to report ill travellers, as per *para* 2.4.3 or death on board an aircraft is an offence under the *Biosecurity Act 2015* and can lead to the application of additional reporting requirements, fines or civil penalties.

2.4.6 Any contaminants on the aircraft from dead or sick people must be cleaned or disinfected in accordance with post-event disinfection procedures for aircraft, as outlined in the World Health Organization 2009 Guide to Hygiene and Sanitation in Aviation, third edition.

2.4.7 For ill passengers that are in transit through Australia the requirements are the same as for those entering Australia. Passengers in transit are not permitted to leave the transit area other than for actual boarding of their outward flight. If the time between arrival and departure allows, and if it is determined to be advisable, the person may either be isolated in a biosecurity facility (i.e. an airport health room) or be allowed restricted access to airport facilities and wait areas as advised by biosecurity officers.

2.5 Pratique

2.5.1 Pratique is the granting of permission to disembark and unload baggage and cargo based on the absence of disease in the passengers and crew. Aircraft entering Australia operate under a system of (automatic) positive pratique. Under this system permission to disembark is automatically granted, unless any of the following applies:

- a. the aircraft has not undertaken prescribed disinsection measures;
- b. the aircraft has reported an individual as having or having had signs and symptoms of a listed human disease, or an individual has died;
- c. a biosecurity official believes an individual on the flight is displaying signs and symptoms of a listed human disease, has been exposed to a listed human disease; or has died during the flight; or
- d. a pre-arrival report consistent with *para* 2.3 was not provided.

2.5.2 Any aircraft not entering under (automatic) positive pratique will be met on arrival by a biosecurity officer. All passengers and crew must remain on board until pratique is granted by this officer. When the biosecurity officer is satisfied that there are no further biosecurity issues, the officer will verbally grant pratique and advise that disembarkation and the unloading of baggage and cargo may commence.

2.6 Biosecurity Waste

2.6.1 All cabin, galley and hold biosecurity waste on board the aircraft must be collected, transported, stored and/or treated by either a service provider that has entered into an approved arrangement with the DAFF - Biosecurity or under the supervision of the DAFF - Biosecurity on a fee for service basis.

2.6.2 Biosecurity waste may include refuse and sweepings from areas of the aircraft, any unconsumed and partly consumed foods, any non-washable items, other waste or materials that may have come in contact with biosecurity waste, animal or plant waste or materials used to pack or stabilise imported goods.

2.6.3 Unmanaged waste, non-compliant handling of waste or inadvertent contamination detected on an aircraft may result in action being required to be taken by the aircraft operator. This can result in delays to the servicing and turn-around of the aircraft.

2.6.4 The operator/commander of an aircraft arriving in Australian territory must ensure that waste has been removed from the aircraft before the aircraft is moved further within Australian territory, unless prior approval has been given by the DAFF - Biosecurity.

2.7 Biosecurity In-Flight Announcement

2.7.1 Prior to arrival in Australia (at top of descent), the operator/commander of all international aircraft must provide, to all travelling passengers and crew, the approved in-flight announcement in audio or video format which outlines Australia's biosecurity requirements. If the audio message cannot be played, commanders must ensure that their crew make a verbal in-flight announcement prior to arrival in Australia.

2.7.2 The delivery of the announcement is a legal requirement under Australian law. The audio or video announcement is available in a number of formats and languages on the DAFF website at: <https://www.agriculture.gov.au/biosecurity/avm/aircraft/guidelines-operators>. The approved announcement must not be edited.

2.8 Required Vaccination and Health Documents

2.8.1 All persons (passengers and crew) arriving in Australia must have the following documents ready for examination by a biosecurity officer and an ABF officer when requested:

- a. An Incoming Passenger Card or crew declaration (as applicable).
- b. A valid International Certificate of Vaccination or Prophylaxis against yellow fever (if in the last six days a person has visited a yellow fever declared country for overnight or longer). A valid certificate is consistent with the requirements in Annex 6 of the *International Health Regulations (2005)*. A list of yellow fever declared countries can be found in the *Australian Biosecurity (Entry Requirements) Determination 2016*.

Note: If the person does not have a valid certificate, entry into Australia will be permitted after assessment by a biosecurity officer.

2.8.2 Passengers and crew will pass from the aircraft to the ABF Entry Control Point where the vaccination certificates will be assessed.

2.8.3 Australia has no vaccination requirements for departure. However, travellers will have to satisfy the requirements of countries to, or through which, they travel.

2.9 Biosecurity screening of baggage

2.9.1 Biosecurity screening of the baggage of passengers and crew, where required, normally occurs at the airport at which passengers and crew disembark the aircraft.

2.9.2 The baggage of passengers and crew disembarking at a particular airport will be unloaded from the aircraft and collected by passengers and crew after they have passed the Entry Control Point.

2.9.3 The baggage of passengers and crew requiring biosecurity screening will be screened by x-ray, detector dog or manual inspection. Screening of baggage by x-ray and/or detector dog may result in subsequent manual inspection.

2.9.4 After any required biosecurity screening of passenger and crew baggage has been completed and after any biosecurity risk goods and/or non-compliance have been addressed, the passengers and crew will remove their baggage from the secondary examination area.

2.10 Conditionally Non-prohibited Goods

2.10.1 The following goods must not be imported into Australia unless the relevant import conditions have been met as outlined in the DAFF - Biosecurity Import Conditions Database (BICON), available online <https://www.bicon.agriculture.gov.au/BiconWeb4.0>.

- a. all animals (including birds and reptiles) and animal products;
- b. cultures of micro-organisms capable of causing human disease and goods of biological origin and other infectious agents;
- c. foodstuffs of animal origin, including meat, poultry, sausages, eggs, cheese and milk;
- d. plants and plant products (e.g. wooden articles, flowers, seeds, fruit and vegetables);
- e. fungi;
- f. human remains, fluids and tissues;
- g. bioremedial agents and fertilizers.

Note: Any goods brought or imported into Australia not meeting import conditions may be treated, exported or forfeited to the Commonwealth for disposal.

2.10.2 *Biosecurity (First Point of Entry) Determinations* detail the first points of entry into Australia through which aircraft and goods may enter Australia. The determination may designate locations within the first point of entry, called biosecurity entry points, where specific classes of goods must be unloaded.

2.10.3 A list of first points of entry is available on the DAFF - Biosecurity website at: www.agriculture.gov.au/import/before/sending/airports.

3. IMMIGRATION/EMIGRATION REQUIREMENTS

3.1 General

3.1.1 Information in this section is based on the *Migration Act 1958*, the *Migration Regulations 1994* and the *Customs Act 1901*.

3.1.2 **ADF** - Commanders of military forces (both Australian and foreign) should ensure that their staff are fully aware of Australia's immigration and customs requirements. The Travel Information Manual (TIM) and the online Timaticweb (www.timaticweb.com) provides a regularly updated, ready-reference for information on Australia's requirements. The master, owner, agent, charterer and operator of a vessel on which a non-citizen is brought into Australia are guilty of an offence against *Section 229(1) of the Migration Act 1958* unless the non-citizen when entering Australia:

- a. is in possession of evidence of a visa that is in effect and that permits them to travel to Australia; or
- b. is deemed to be a person having a prescribed status and holds a special purpose visa;
- c. is a transit passenger who meets certain criteria;
- d. is eligible for a special category visa; or
- e. is entering by sea and has a maritime crew visa.

3.1.3 A person who is guilty of an offence against *Section 229(1) of the Migration Act* is liable, upon conviction, to a fine not exceeding AUD10,000 for each non-citizen who is brought to Australia. In lieu of prosecution, airlines may pay a penalty of AUD5000.

Note: ADF - Passengers who are unable to comply with the Immigration requirements on arrival in Australia may not be granted an entry permit under the Migration Act 1958. In such circumstances, the transporting organisation will be responsible for removing the passenger from Australia without charge to the Australian Government. An ADF Command Headquarters may be prosecuted for an offence under Section 28 of the Migration Act 1958 if a passenger should enter Australia from the Command Headquarters' aircraft without a permit.

3.2 Advance Passenger Processing (APP) Reporting of Passengers and Crew

3.2.1 This section from Airservices Australia AIP not applicable to ADF.

3.3 Inwards Clearance - Passports or Other Travel Document

3.3.1 All persons seeking to enter Australia, whether for a visit or temporary or permanent residence, must identify themselves. In the case of non-citizens, they must hold or be eligible for a visa. Passports are the most common and preferred type of travel document for identification purposes. A valid passport is required for travel to Australia from all overseas destinations.

3.3.2 Some countries still issue family group passports which may cover, for example, a husband and/or wife and children. For entry control purposes, Australia accepts dependents that are endorsed on such passports only when accompanied by the principal holder.

3.3.3 Passports are not required for holders of the following:

- a. Certificates of Identity, Documents of Identity, or "Documents for Travel to Australia" or Australian Migration Status ImmiCards issued by Australian authorities.
- b. Documents of Identity, issued by a country other than Australia. (Documents must have a photograph of the bearer and re-entry authority to the country of issue.)
- c. Laissez-passer (travelling on duty), issued by the United Nations.

- d. Military identity documents and movement orders issued to members of:
 - 1) armed forces that have a Status of Forces Agreement with Australia (France, Japan, Papua New Guinea, Republic of the Philippines, Singapore, USA, Malaysia and New Zealand);
 - 2) Asia-Pacific armed forces (Brunei, Fiji, Malaysia, Thailand or Tonga); or
 - 3) Commonwealth forces of Antigua, Bahamas, Barbados, Belize, Canada, Grenada, Jamaica, Mauritius, New Zealand, Papua New Guinea, Saint Lucia, Saint Vincent and the Grenadines, Solomon Islands, St Christopher and Nevis, Tuvalu, and the United Kingdom of Great Britain and Northern Ireland.
 - 4) More information is available at:
www.abf.gov.au/entering-and-leaving-australia/crossing-the-border/military-personnel

3.3.4 Certificates for air crew members, travelling on duty as operational or positioning crew:

- a. operational crew must carry a current military identity document and a valid passport; and
- b. positioning crew not listed as crew members must carry a valid passport and a letter from their employer certifying air crew status and setting out the purpose of the persons' travel to Australia and the arrangements for them to leave Australia.

3.3.5 Documents issued to stateless persons as follows:

- a. Certificate of Identity, provided it holds proof to re-enter the country of residence; or
- b. Titre de Voyage issued to persons recognised as refugees under the 1951 Convention Relating to the Status of Refugees.

3.3.6 Domestic passengers who are only travelling on domestic sectors of international flights within Australia must carry acceptable forms of photo-identification.

3.4 Visa Requirements

3.4.1 With the exception of New Zealand passport holders and prescribed classes of persons under the Special Purpose visa framework, see *para 3.4.12 and 3.4.13*, all non-citizens are required to have a visa for travel to Australia.

3.4.2 Carriers are required to ensure non-citizen passengers travelling to Australia hold, or are eligible to hold, a valid visa. Persons in possession of expired visas must not be carried to Australia. Visas for travel to Australia may be for either single or multiple journeys within the validity of the visa. Visas facilitate travel. but do not guarantee entry. Visitors who fail to satisfy border checks can be refused entry to Australia.

3.4.3 The majority of visas granted will not be evidenced by a stick-in visa label in a passport as visa labels ceased to be issued from 01/09/2015. Existence of a visa should be verified by airlines at check-in via the Advanced Passenger Processing (APP) system.

3.4.4 There are two types of visas: temporary and permanent.

3.4.5 **Electronic Travel Authorities (ETAs)** are temporary visas for short term stays for tourism or business visitor activities.

3.4.6 Individuals, travellers, airline representatives or registered travel agents may apply for an ETA, through the ETA APP, but the applicant or traveller must be physically present in order to meet the 'LIVE' image requirement for the ETA APP.

3.4.7 Bearers of the following passports are eligible to apply for an ETA issued by the following countries:

Andorra	France	Japan	Norway	Switzerland
Austria	Germany	Liechtenstein	Portugal	Taiwan (excluding official diplomatic passports)
Belgium	Greece	Luxembourg	San Marino	United Kingdom (British Citizens and British Nationals Overseas)
Brunei	Hong Kong	Malaysia	Singapore	
Canada	Iceland	Malta	South Korea	USA
Denmark	Ireland	Monaco	Spain	Vatican City

Finland	Italy	Netherlands	Sweden	
---------	-------	-------------	--------	--

3.4.8 Further information regarding these visas and the visa application process can be found at www.eta.homeaffairs.gov.au.

3.4.9 For industry users (travel agents and airline representatives), additional guidance is available through the Australian ETA APP Guidance notes (pdf).

3.4.10 The Australian ETA APP can be downloaded from the Apple Store or Google Play at Australian ETA APP.

3.4.11 The industry channel for ETA lodgment is no longer available to airlines to apply for ETA on behalf of passengers.

3.4.12 **Special Purpose Visas (SPV)** are a class of temporary visa taken to have been granted by operation of law to certain persons or classes of persons.

3.4.13 SPV holders are not required to complete an application form provided they belong to any of the following classes of persons:

- a. Members of the armed forces of France, Japan, Papua New Guinea, Republic of the Philippines, Singapore, Turkey, USA, Malaysia and New Zealand under the Status of Forces Agreement (SOFA) travelling on duty (movement orders issued from an official source of the relevant country) and holding military identity documents;
- b. Members of Asia Pacific armed forces (Brunei, Fiji, Malaysia, Thailand or Tonga) travelling on duty and holding military identity documents and movement orders;
- c. Members of Commonwealth armed forces travelling on duty (movement orders issued from an official source of the relevant country) and holding military identity documents (Antigua, Bahamas, Barbados, Belize, Canada, Grenada, Jamaica, Mauritius, New Zealand, Papua New Guinea, Saint Lucia, Saint Vincent and the Grenadines, Solomon Islands, St Christopher and Nevis, Tuvalu, and the United Kingdom of Great Britain and Northern Ireland);
- d. Members of the civilian component of SOFA provided they hold passports and certificates stating that the person is a member of the civilian component of the armed forces of the relevant country;
- e. Dependants of SOFA (excluding dependents accompanying a Japanese SOFA member), Asia Pacific and Commonwealth armed forces listed above provided they hold a passport and either movement orders or certificates stating they are a spouse or a dependant of a member of the armed forces, or the civilian component of the armed forces of the relevant country, and are accompanying or joining that member;
- f. Airline crew members travelling as passengers in the course of employment, who will be departing Australia as crew of an aircraft ("positioning crew"), provided they are in possession of a letter from the employer regarding aircrew status, purpose of travel and arrangements for departure from Australia within 5 days ("Certificate of Status") This SPV arrangement is not for air crew seeking to work specifically on domestic sectors or to perform other duties in Australia. An appropriate visa should be applied for in these cases; and
- g. Transit passengers (not applicable to stateless persons and refugees) who are direct transit passengers arriving and departing by aircraft are taken to hold a special purpose visa provided they:
 - i will be continuing their journey to a third country by the same or a connecting aircraft within eight hours of arrival in Australia;
 - ii do not leave the airport transit lounge except to continue their journey;

Note: If a person in this class seeks to leave the transit lounge, i.e. seek immigration clearance, the special purpose visa will cease.

- iii are in possession of confirmed onward reservations and hold correct documentation for entry to their destination; and
- iv be a citizen of the following countries:

Andorra	Finland	Luxembourg	Portugal	Sweden
Argentina	France	Malaysia	Qatar	Switzerland
Austria	Germany	Malta	Republic of Bulgaria	Thailand
Belgium	Greece	Mexico	Republic of South Africa	Tonga
Brunei	Hungary	Monaco	Republic of the Marshall Islands	Tuvalu
Canada	Iceland	Nauru	Romania	United Arab Emirates
Chile	Indonesia	Netherlands	Samoa	United Kingdom (including its colonies)
Croatia	Ireland	New Zealand	San Marino	United States of America
Cyprus	Italy	Norway	Singapore	Uruguay
Czech Republic	Japan	Oman	Slovakia	Vanuatu
Denmark	Kiribati	Palau	Slovenia	Vatican
Estonia	Latvia	Papua New Guinea	Solomon Islands	
Federated States of Micronesia	Liechtenstein	Philippines	South Korea	
Fiji	Lithuania	Poland	Spain	

- v are a resident of Hong Kong holding Hong Kong Special Administrative Region (HKSAR) passports or British National Overseas (BNO) passports;
- vi are a resident of Taiwan holding a passport issued by the Authorities of Taiwan (other than passports purported to be official or diplomatic passports);
- vii are official passport holders from India;
- viii are diplomatic passport holders, excluding holders of:
 - Arab Non-National Passports; and
 - diplomatic passports from the following countries:

Afghanistan	Democratic People's Republic of Korea	Lebanon	Pakistan	Somalia
Algeria	Egypt	Libya		Sudan
Angola	Iran	Madagascar	Republic of Yemen	Syria
Bahrain	Iraq	Mauritania	Russian Federation	Tunisia
	Jordan	Morocco	Saudi Arabia	Zimbabwe
Comoros	Kuwait		Sierra Leone	

- h. are members of the Royal family or a Royal Party.
- i. are official guests of the Australian Government and accompanying members of their immediate family.

3.4.14 **Special Category Visa (SCV).** A New Zealand citizen, who holds and produces a valid New Zealand Passport to an officer or authorised system and answers the health and character questions either on the Incoming Passenger Card (IPC) or via the SmartGate, may be eligible to be granted the SCV at the border.

3.4.15 **Merchant Seaman.** The visa regulations for merchant seaman if they arrive in Australia by air are the same as for holders of normal passports. The Australian Maritime Crew Visa (MCV) does not permit

GEN 1.3

travel or entry to Australia by air. Merchant Seamen holding an MCV seeking to fly to Australia must hold a second visa issued by the Australian Government.

3.5 Returning Non-citizen Permanent Residents of Australia

3.5.1 Non-citizens who are or were permanent residents of Australia wishing to travel overseas after their travel facility period has expired must hold a permanent visa in effect if they wish to return to Australia as permanent residents. This may include holding:

- a. an old style authority to return or Return Endorsement issued between 1976 and 1986;
- b. a Resident Return Visa (RRV); or
- c. another type of permanent visa in effect that allows travel to Australia.

For more information, see: Overseas travel as a permanent resident at:

<https://immi.homeaffairs.gov.au/visas/permanent-resident/overseas-travel>

3.5.2 Permanent residents who hold an "Authority to Return" or "Return Endorsement" which are in the form of a wet stamp in their passport may not be recorded electronically in Home Affairs Departmental systems. Airlines will need to confirm with the Department of Home Affairs whether holders of these wet stamps are returning to Australia within three years of their most recent departure. These old style wet stamps issued between 1976 and 1986 are also acceptable in expired or cancelled passports or other travel documents provided the holder also has a valid foreign travel document.

3.6 Incoming Passenger Cards

3.6.1 Incoming passenger cards are required to be completed by all passengers except for:

- a. crew members who are on duty;
- b. direct transit passengers described in *sub-para 3.4.13g*.
- c. other individuals specified in *Migration Regulations 1994, Schedule 9, Part 2*.

3.6.2 Supplies of Incoming Passenger Cards should be maintained on aircraft and issued to passengers in ample time for completion before arrival at the immigration clearance airport in Australia. If passengers cannot complete their own cards because of age or physical infirmity, the cards must be completed by the accompanying parent, guardian or attendant.

3.6.3 Incoming Passenger Cards are available in English and a number of foreign languages. All incoming passenger cards must be completed in the English language.

3.7 Inward Clearance - Documentation

3.7.1 Immigration examination of passengers is generally done at the point of final disembarkation in Australia, except when special arrangements to the contrary have been made.

3.7.2 For the purposes of examination, the following documents must be ready for presentation to the ABF Officer:

- a. Aircraft Crew
 - 1) For operational flight crew a valid passport and a certificate of status from their employer in the form of an airline ID card.
 - 2) Positioning crew not listed as crew members must carry a valid passport and a letter from their employer certifying air crew status and setting out the purpose of the persons' travel to Australia and the date for them to leave Australia.
 - 3) A completed Form B465 Crew Declaration, which can be accessed via: www.abf.gov.au/help-and-support/forms
- b. Passengers
 - 1) In the case of Australian citizens, valid Australian passports, or other valid documents of identity having the characteristics of passports, and Incoming Passenger Cards.
 - 2) In the case of New Zealand citizens, valid New Zealand passports and Incoming Passenger Cards.
 - 3) In the case of all other persons, valid national passports, or other acceptable documents listed in *para 3.4.2*, with visa as required for entry into Australia, and Incoming Passenger Cards.

3.8 Outwards Clearance - Documentation

3.8.1 **APP reporting of passengers and crew.** This section from Airservices Australia AIP not applicable to ADF.

4. CUSTOMS REQUIREMENTS

4.1 Inward Clearance - Documentation

4.1.1 The aircraft captain (or authorised agent) of an aircraft landing at a designated international airport which is the first airport of call in Australia shall furnish the following documents to the Australian Border Force (see *GEN 1.2 para 1.3*):

- a. Impending Arrival Report, lodged in the ICS electronically;
- b. Actual Arrival Report;
- c. Cargo Report;
- d. Crew Declaration;
- e. List of Stores.

4.2 Examination of Crew and Passengers - Arrivals

4.2.1 Complete ABF examination of the baggage of passengers and crew members is normally made at the airport where the passengers and crew members finally disembark from the aircraft.

4.2.2 Baggage of all persons (including crew) destined for that airport will be unloaded and brought into the baggage examination area of the terminal building for examination. Crew baggage will be separated from passenger baggage. Cargo will be unloaded for immediate delivery to a depot licensed by the Australian Border Force.

4.2.3 ABF officers may maintain surveillance over the unloading of all baggage and cargo and ensure that it is taken directly to the baggage examination area and depot respectively. An officer may also check goods owned by, or in possession of, the crew against the List of Stores and Crew Declaration. See *GEN 1.2 para 1.3*.

4.2.4 Passengers and crew, after disembarking, must proceed to the Entry Control Point for completion of Customs, Immigration and Biosecurity requirements.

4.2.5 All persons entering Australia who are in possession of Australian currency, foreign currency, cheques, travellers cheques, money orders or bearer negotiable instruments where the value of all combined is AUD10,000 or more, must complete a Cross-Border Movement-Monetary Instrument reporting form. Reporting forms for this purpose are available from air and sea ports, or from the Australia Transaction Reports and Analysis Centre (AUSTRAC). There is no limit to the amount of currency that can be brought into Australia, but failure to declare the currency may result in seizure and prosecution.

4.2.6 After the examination of crew and passenger baggage has been completed, and customs duty and tax (if any) paid, the persons concerned will be authorised to remove their baggage from the secondary examination area.

4.3 Outward Clearance - Documentation

4.3.1 The aircraft captain (or authorised agent) of an aircraft departing from a designated international airport, which is the first airport of departure from Australia, shall furnish the following documents to the ABF Officer (see *GEN 1.2 para 1.3*):

- a. Export Permits (when required);
- b. Departure Report;
- c. Outwards Manifest.

4.3.2 When aircraft landing in Australia are in transit, the aircraft captain or authorised agent will present documents for inward clearance. The ABF Officer will, where requested, sign and stamp the General Declaration presented on arrival in Australia and return it to the aircraft captain. A certificate of clearance will be provided to the pilot upon completion of all reporting formalities and permits the aircraft to depart the airport.

4.4 Examination of Crew and Passengers – Departures

4.4.1 All persons leaving Australia who are in possession of Australian currency, foreign currency, cheques, travellers cheques, money orders or bearer negotiable instruments where the value of all combined is AUD10,000 or more, must complete a Cross-Border Movement-Monetary Instrument reporting form. Reporting forms for this purpose are available from air and sea ports or from AUSTRAC. There is no limit to the amount of currency that can be taken out of Australia, but failure to declare the currency may result in seizure and prosecution.

4.4.2 The baggage of outward passengers may be subject to Customs examination.

4.4.3 Passengers departing Australia are required to, subject to exemptions, pay the Passenger Movement Charge whether ticketed or not. See *GEN 4.1*.

4.4.4 Information for visitors can be found at: [https://www.abf.gov.au/entering-and-leaving-australia/crossing-the-border/passenger-movement/passenger-movement-charge-\(pmc\)](https://www.abf.gov.au/entering-and-leaving-australia/crossing-the-border/passenger-movement/passenger-movement-charge-(pmc)).

5. TRANSIT PASSENGERS - CLEARANCE REQUIREMENTS AND PROCEDURES WITHIN AUSTRALIA

5.1 Immigration Requirements

5.1.1 Passengers who are in direct transit on through-flights will not be required to complete Incoming Passenger Cards. This concession applies irrespective of whether the passengers are transiting on the same or different aircraft.

5.1.2 Direct transit passengers will need to hold an appropriate visa unless they meet requirements in *para 3.4.13*, in which case they will be taken to hold a special purpose visa.

5.1.3 Passengers disembarking in Australia (i.e. leaving the transit area) from such a through-flight must present passports/travel documents, visas, Incoming Passenger Cards and airline tickets evidencing confirmed onward booking to a third country.

5.1.4 Where international passengers leave the transit area and transfer to another international flight at the same airport, Incoming Passenger Cards, passport/travel documents and visas (unless within the exempt categories) are required to be presented.

5.1.5 A "through-flight" in this context is as defined in *Chapter 1 - Definitions and Applicability*, of *ICAO Annex 9 (Facilitation)* to the Convention on International Civil Aviation:

"Through-Flight". A particular operation of aircraft, identified by the operator by the use throughout of the same symbol from point of origin via any intermediate points to point of destination.

5.1.6 This "through-flight" definition implies a single operator and does not prevent the use of more than one aircraft for a through-flight. The recording of dual flight numbers, when applicable, should satisfy, for local purposes, the requirements of the definition in so far as retention of 'the same symbol' from point of origin to point of destination is concerned.

5.2 Customs and Biosecurity Requirements

5.2.1 Transit passengers (either proceeding on the same aircraft or another aircraft) are not required to make a customs or biosecurity declaration provided they do not pass through a customs control point.

5.2.2 Personal hand baggage covers only normal personal requisites needed by the passenger for the period of the stopover. Such baggage, however, is liable to inspection.

5.2.3 Passengers having other articles may be required, at the discretion of an ABF or biosecurity officer, to make a customs declaration.

5.3 Requirements for the Airline Representative

5.3.1 **Passenger and Crew Manifests.** The airline representative should hand over the following manifests to an ABF officer:

- a. a manifest of travellers and crew in transit who are joining the flight, having departed from other ports in Australia;
- b. a manifest of travellers in transit who have arrived on an international flight and are connecting with another international flight;

- c. a flight interruption manifest or manifest of travellers/crew who have been offloaded onto alternative international flights rather than not departing. This will assist in reconciling traveller movements post processing.

5.3.2 **Coordinating Traveller/Crew Processing.** The ABF officer and airline representative should coordinate passenger/crew processing by separating the passenger and crew groups of:

- a. international traveller/crew transiting Australia;
- b. international traveller/crew originating from port of departure;
- c. international traveller/crew originating from another port in Australia;
- d. domestic travellers;
- e. unlawful non-citizens, including removees.

5.3.3 **Cancelled or Aborted Flights Departing Australia.** Following the decision to cancel or abort a flight, an airline representative must advise an ABF officer.

6. LANDINGS AT DESIGNATED ALTERNATE AIRPORTS OR ELSEWHERE THAN AT DESIGNATED INTERNATIONAL AIRPORTS WITHIN AUSTRALIA

6.1 General

6.1.1 Landings elsewhere than at major international, restricted use international, and international non-scheduled flight airports may be divided into two categories:

- a. landings at designated alternate airports to international airports; and
- b. landings elsewhere than at a designated alternate airport which are made as a result of an emergency.

6.1.2 Under the requirements of the *Customs Act 1901* and the *Migration Act 1958*, an aircraft engaged on an international flight which has landed elsewhere than at a designated international airport is required to proceed directly to a designated international airport where Customs and Immigration clearances can be completed. Biosecurity clearance is normally undertaken at the airport of entry.

6.1.3 Where safe to do so, it is preferable that crew and passengers remain on board the aircraft so they do not have to undergo security clearance when the flight resumes to the original airport of destination. The pilot may disembark to perform the necessary safety inspections. An airline representative may board with the relevant documents.

6.1.4 This section from Airservices Australia AIP not applicable to ADF.

6.2 Designated Alternate Airports to International Airports

6.2.1 A list of the designated Australian alternate airports can be found at *GEN 1.2 para 2.3*.

6.2.2 General procedures effective for when a landing is to be made by an international aircraft at a designated alternate airport are as follows:

- a. **Biosecurity.** Biosecurity officers of the DAFF are not stationed permanently at the airport, and the airport is serviced for international arrivals under a request for service arrangement.
- b. **Customs and immigration.** ABF Officers of the Department of Home Affairs are not stationed permanently at the airport. The relevant District Office or a Local Area Command in the ABF will be established and be responsible for coordinating the border agency response. It will establish ongoing communication with the airport, airline, biosecurity officers and police if required

6.2.3 The Airline or its agent/representatives may be responsible for covering additional expenses relating to the positioning of resources from another border agency base to an Alternate Airport.

6.2.4 Additional or varied procedures are in place at the alternate airports outlined in the following table:

Airport	Additional or Varied Biosecurity, Customs and Immigration Procedures
Alice Springs	An officer of the Northern Territory police (ABF representative) will exercise surveillance over the aircraft while it is at the airport.
Gold Coast	Biosecurity and ABF officers are stationed at Gold Coast Airport and will be available to grant overnight or full clearances, as required, provided reasonable advance notice of the diversion is given by Airservices Australia.
Kalgoorlie	An officer of the West Australian police (ABF representative) will have the responsibility to exercise surveillance over the aircraft while it is at the airport.
Learmonth	Goods must not be landed at this airport unless an application has been made under <i>Section 146 of the Biosecurity Act 2015</i> and approval granted. An officer of the West Australian police (ABF representative) will have the responsibility to exercise surveillance over the aircraft while it is at the airport.
Port Headland	Biosecurity and ABF officers are stationed at Port Hedland but not at the Airport.
Tindal	Goods must not be landed at this airport unless an application has been made under <i>Section 146 of the Biosecurity Act 2015</i> and approval granted. Aircraft other than jet fighter aircraft must not be landed at this airport unless an application has been made under <i>Section 239 of the Biosecurity Act 2015</i> and approval granted. An airline representative/RAAF personnel may board with the relevant documents.
Townsville	Biosecurity and ABF officers are stationed at Townsville but not at the Airport.

6.3 Landing made other than at a Designated Alternate Airport

If a landing is made other than at a designated international or international alternate airport, the aircraft captain or the next senior crew member available shall report the landing as soon as practicable to the National Operations Management Centre (NOMC) in Airservices Australia. This notification may be made through aeronautical channels (or by other means if this method of communication is not available).

6.3.1 Procedures effective for such landings are as follows:

6.3.2 The relevant District Office or a Local Area Command in the ABF will be established and be responsible for coordinating the border agency response. It will establish ongoing communication with the airport, airline, Department of Agriculture biosecurity officers and Federal or State police if required. This will allow an assessment to be made as to whether there is a need for a border agency presence or other if other action is required.

6.3.3 The aircraft captain is responsible for ensuring the following:

- a. If pratique has not been granted to the aircraft at any previous landing in Australian territory, contact between passengers, crew and other persons is avoided.
- b. Cargo, stores, baggage and mail, if required to be removed from the aircraft for safety reasons, must be deposited in a nearby area and remain there pending completion of the necessary formalities. Mail must be disposed of as is required pursuant to *para 7.4.4 of ICAO Annex 9*.
- c. Any foodstuffs of overseas origin, or any plant material, are not removed from the aircraft except where local food is unobtainable. All food refuse (including peelings, cores, and stones of fruit) must be collected by the aircraft operator and returned to the galley refuse container. The contents of the galley refuse container should not be removed from the aircraft except for hygiene reasons, in which case they must be disposed of, as directed by a biosecurity official.

6.3.4 Notwithstanding the provisions set out above, the aircraft captain, while awaiting the instructions of the District Office or Local Area Command, or if unable to get in touch with such authorities, may take such emergency measures as deemed necessary for the health and safety of the passengers and crew. This may include the securing of suitable accommodation and the avoiding or minimising of loss or destruction to the aircraft itself and its load.

7. CHARTER FLIGHTS - GUIDELINES FOR CLEARANCE

7.1 This section from Airservices Australia AIP not applicable to ADF.

8. DESIGNATED INTERNATIONAL AIRPORTS - AUSTRALIAN EXTERNAL TERRITORIES - ENTRY AND DEPARTURE REQUIREMENTS AND PROCEDURES

8.1 Biosecurity Requirements for External Territories

8.1.1 The *Biosecurity Act 2015* extends to the external Territories of Christmas Island, Cocos (Keeling) Islands and Norfolk Island.

8.1.2 All aircraft (including aircraft from Australia) arriving at Christmas Island, Cocos (Keeling) Islands and Norfolk Island are required to meet the first point of entry, disinsection, pre-arrival reporting, mandatory passenger announcement and pratique requirements outlined in the *Biosecurity Act 2015* and subordinate legislation, including the *Biosecurity Regulations 2016* and the *Biosecurity (Human Health) Regulation 2016*. See *para 2.1.2* for more information.

8.1.3 Christmas Island, Cocos (Keeling) Islands and Norfolk Island each have their own goods determination which outlines the import conditions for goods that are to be brought or imported into these external Territories, including:

- a. Biosecurity (Prohibited and Conditionally Non-prohibited Goods – Norfolk Island) Determination 2016
- b. Biosecurity (Conditionally Non-prohibited Goods – Christmas Island) Determination 2016
- c. Biosecurity (Conditionally Non-prohibited Goods – Cocos (Keeling) Islands) Determination 2016.

These determinations can be found on the Federal Register of Legislative Instruments website: www.legislation.gov.au

8.2 External Territory International Airports

8.2.1 The following is a list of the designated Australian External Territory International Airports (see also *GEN 1.2*):

- a. Christmas Island
- b. Cocos (Keeling) Islands
- c. Norfolk Island.

Note: Operations by aircraft at the above airports are limited to the pavement strengths shown against these airports in AIP ERSA. Prior application must be made for a pavement concession when this is necessary.

8.2.2 Aircraft operators should use the contact details listed in ERSA FAC to obtain specific information and/or obtain copies of appropriate documents for these airports.

8.3 Territory of Christmas Island

8.3.1 Summary of Documents to be Presented by Pilot or Authorised Agent

- a. **On Arrival:**

General Declaration (showing names of crew)	2 copies
Passenger Manifest	2 copies
Cargo Manifest	2 copies
Customs Clearance (from last airport)	2 copies
- b. **On Departure:**

General Declaration (showing names of crew)	1 copy
Cargo Manifest	1 copy
Customs Clearance	1 copy

8.3.2 Immigration Requirements - Christmas Island

- a. Normal Australian immigration procedures apply when entry is made from outside Australia. All non-citizens must hold visas prior to arrival at Christmas Island when entering from outside Australia.
- b. No passports or visas are required when arriving on Christmas Island from the Australian mainland or Tasmania; however, some form of government-issued identification must be produced for clearance through Customs/Immigration; e.g. Medicare Card or Driver Licence.

8.3.3 Customs Requirements - Christmas Island

- a. **Inwards.** Each passenger must declare all prohibited imports.
- b. **Outwards.** Each passenger must declare all prohibited exports.

8.3.4 Passenger Movement Charge - Christmas Island

- 8.3.5 This section from Airservices Australia AIP not applicable to ADF.

8.4 Territory of Cocos (Keeling) Islands

8.4.1 Immigration Requirements - Cocos (Keeling) Islands

- a. Normal Australian immigration procedures apply when entry is made from outside Australia. All non-citizens must hold visas prior to arrival at Cocos (Keeling) Islands when entering from outside Australia.
- b. No passports or visas are required when arriving on Cocos (Keeling) Islands from the Australian mainland or Tasmania; however, some form of identification must be produced for clearance through Customs/Immigration in Perth (e.g. ADF identity document) unless intending to depart Cocos (Keeling) Islands for a foreign country.
- c. There are no statutory restrictions on visits to Cocos (Keeling) Islands. It is preferred that accommodation is confirmed prior to departure.

8.4.2 Customs Requirements - Cocos (Keeling) Islands

- a. Inwards passengers must complete an Incoming Passenger Card for both Customs and Immigration purposes. The card includes a Customs declaration, which includes a requirement to declare all prohibited imports.
- b. **Outwards.** Each passenger must declare all prohibited exports.

8.4.3 Passenger Movement Charge - Cocos (Keeling) Islands

- a. This section from Airservices Australia AIP not applicable to ADF.
- b. This section from Airservices Australia AIP not applicable to ADF.

8.5 Territory of Norfolk Island

8.5.1 Summary of Documents to be Presented by Pilot or Authorised Agent

- a. **On Arrival:**

General Declaration (showing names of crew)	2 copies
Passenger Manifest	2 copies
Cargo Manifest	2 copies
Customs Clearance (from last airport)	2 copies
- b. **On Departure:**

General Declaration (showing names of crew)	1 copy
Cargo Manifest	1 copy
Customs Clearance	1 copy

8.5.2 Immigration Requirements - Norfolk Island

- a. Normal Australian immigration procedures apply when entry is made from outside Australia. All non-citizens must hold visas prior to arrival at Norfolk Island when entering from outside Australia.
- b. No passports or visas are required when arriving on Norfolk Island from the Australian mainland or Tasmania; however, some form of government issued identification must be produced for clearance through Customs/Immigration, e.g. Medicare Card or Driver Licence.
- c. Flights from an overseas location to Norfolk Island via mainland Australia (including Tasmania) must complete immigration clearance when the aircraft arrives in mainland Australia.
- d. This section from Airservices Australia AIP not applicable to ADF.

8.5.3 Customs Requirements - Norfolk Island

- a. **Inwards.** Each passenger must declare all prohibited imports.
- b. **Outwards.** Each passenger must declare all prohibited exports.

8.5.4 Passenger Movement Charge - Norfolk Island

- a. This section from Airservices Australia AIP not applicable to ADF.

9. ADF - DEFENCE LOGISTICS MANUALS (DEFLOGMAN)

9.1 Defence Compliance with Australian Biosecurity Measures

9.1.1 The following DEFLOGMAN procedures have been extracted from DEFLOGMAN Part 2 Volume 8 Chapter 7, to assist aircrew comply with ADF biosecurity obligations. The DEFLOGMAN procedures are additional to the biosecurity procedures contained in this chapter, and are by no means a comprehensive extract. Aircrew should consult DEFLOGMAN for a complete understanding of ADF biosecurity requirements.

9.2 Destruction of Insect Procedures for Aircraft

9.2.1 Aircrew are responsible for the disinsection of Defence aircraft arriving in Australia from overseas. The two sections of the aircraft which are to be sprayed are the passenger/cargo cabin and the cargo holds. Disinsection of single and dual seat fighter aircraft on arrival in Australia is not required, however, quarantinable waste such as animal and plant material must be removed from the aircraft for appropriate disposal by Department of Agriculture biosecurity officer.

9.3 Passenger/Cargo Cabin Disinsection

9.3.1 Disinsection of the cabin involves:

- a. preflight spraying of the flight deck, toilet areas, overhead and side lockers and galley; and
- b. top of descent spraying of passenger/cargo compartment.

9.3.2 **Preflight spraying.** On aircraft used for VIP flights, a pre-flight spray is to be carried out at the last port before departure to Australia and must be applied to the flight deck, toilets, and fully enclosed lockers before crew and passengers are boarded. The aerosol to be used is two per cent permethrin, with a propellant and solvent cleared for use by the Department of Agriculture. Cans must have a discharge rate of 1 gram per second and mass medium droplet diameter of 8 micrometers with droplet diameters in the range of 3 to 10 micrometers. The recommended can size is 100 grams, and the aerosol formulation must be clearly shown on the label.

9.3.3 **Top of descent spraying.** The passenger and main cargo compartment of the aircraft are to be sprayed at the top of descent. A crew member holding two cans of spray directed towards the ceiling of the aircraft should walk the length of the aircraft at a pace of one step per second. The formula of the insecticide used for Top of Descent spraying is to be two per cent d.phenothrin containing a propellant approved for use in aircraft. Cans and nozzles must be designed and manufactured to deliver an even distribution of spray at an emission rate of one gram per second and a mass medium droplet diameter of 8 micrometer, with droplet diameters in the range of 3 to 10 micrometers. The aerosol formulation is to be clearly shown on the label.

9.4 Cargo Hold Disinsection

9.4.1 The below deck cargo holds of the aircraft are to be disinsected at the last port, before entering Australia, by the aircraft crew. Spraying may be carried out manually or by the use of one-shot aerosol cans located in the cargo hold and fired with the hold doors being immediately closed. Recommended spray can size for each hold is 150 grams. Used cans are to be left inside the holds for inspection and removal by a Biosecurity Officer on arrival. The formula of the insecticide used for cargo hold spraying is to be two per cent d.phenothrin, two per cent permethrin, eight per cent solvent. The following conditions also apply to cargo hold disinsection:

- a. under no circumstances should the cargo hold doors be opened after arrival at the first port of entry into Australia without the presence or approval of a Biosecurity Officer; and
- b. the used spray cans are to be located at a convenient retrieval point in the hold, for example, in a mesh bag or internal webbing attached to the door.

9.4.2 In the event that empty or partly used spray cans cannot be produced or that in the opinion of the Biosecurity Officer spraying has not been carried out, the Biosecurity Officer will direct the aircrew to carry out the necessary spraying. If spray cans are not available on the aircraft the Biosecurity Officer will provide the necessary number of cans.

9.4.3 The details of disinsection sprays are outlined in the Schedule of Aircraft Disinsection Procedures Department of Agriculture and Ministry of Agriculture and Forestry Biosecurity New Zealand Version 4.0. This document can be found in:
<http://www.agriculture.gov.au/biosecurity/avm/aircraft/disinsection/procedures>.

9.5 International Flights Arriving at Military Airfields

9.5.1 The Senior Australian Defence Force Officer at a military airfield at which an international aircraft first lands are to direct that:

- a. the Department of Agriculture biosecurity officer is given adequate notice of the arrival of such aircraft;
- b. a suitable location is designated as the parking area for such Aircraft;
- c. unauthorised personnel are not to approach within 30 metres of the aircraft and that the crew and passengers do not deplane until authorised by the biosecurity officer;
- d. when necessary, a suitable room is provided as a quarantine inspection centre;
- e. toilet wastes removed from the aircraft are disposed of in the base sewerage system; and
- f. coordinate Base personnel and resources, if required, to support the Department of Agriculture in its biosecurity duties.

9.5.2 On arrival of international aircraft at a military airfield the biosecurity officer will carry out the following duties:

- a. ensure that the 'Top of Descent Spraying' has been conducted in accordance with the Disinsection procedures;
- b. ensure that the health of passengers and crew is satisfactory;
- c. issue a Certificate of Pratique to the aircraft in accordance with the Biosecurity Act 2015;
- d. ensure that the quarantinable waste is removed from the aircraft for appropriate disposal; and
- e. permit the cargo hold to be unloaded if spraying has been in accordance with Annex A.

9.5.3 Duty personnel are to assist the biosecurity officer in carrying out the duties prescribed in this Chapter. Additionally, air movements staff shall immediately notify the biosecurity officer of any accumulation of soil or insect infestation in the international aircraft's cabin, cargo holds, or items of cargo unloaded from the aircraft. The biosecurity officer will then determine the level and nature of the treatment required.

9.5.4 Defence must maintain a record of all international aircraft arriving at a military airfield, detailing the flight number, last port of call before Australia, and the number of passengers/crew.

9.6 Military Working Dogs

9.6.1 Each dog is to be accompanied by a copy of a valid import permit, obtained before leaving Australia. This is obtainable from either Department of Agriculture Live Animal Imports Canberra, or the Department of Agriculture Chief Quarantine Officer (Animals) of the State or Territory of Australia to which the return to Australia is to be made. Protocols, tailored to specific deployments, may be established by Department of Agriculture. The biosecurity requirements for the importation of military working dogs are in Annex C.

9.7 Military Working Dogs - Biosecurity

9.7.1 Each dog should be vaccinated in accordance with the requirements of the country to which it is deploying prior to departure from Australia. The dog's record of service containing past movements, vaccination and veterinary treatment is to accompany the dog.

9.7.2 Advice must be sought from Department of Agriculture on the suitability of portable kennels and the cleaning requirements of kennels and handling equipment prior to entry to Australia.

9.7.3 Employing units must liaise with Department of Agriculture to determine the delivery details for returning dogs to Quarantine centres. The Quarantine centres should provide food and veterinarian services during the quarantine period.

9.8 Control of Foodstuffs and Food Waste

9.8.1 Foodstuffs originating in overseas countries, and the waste from such foods, can carry and transmit a range of serious animal, plant and some human diseases. They also pose a risk of cross-infection or infestation of Australian-sourced foods carried on ships and aircraft. There is also a risk, although slight, of contamination of existing food supplies during visits to overseas countries, even where additional food is not purchased.

9.8.2 All foodstuffs and food related waste on board overseas Defence or Defence contracted aircraft entering Australia is subject to biosecurity control, which remains in force whilst the aircraft is in Australia and the quarantinable material remains on board. Potable water for consumption on the aircraft is not subject to biosecurity action. Any unconsumed food not removed from the aircraft must be regarded as quarantine bonded while the aircraft remains on the ground. Bonded food may be consumed while the aircraft is in the air between ports in Australia, however when the aircraft reaches its catering port in Australia, all such food must be disposed of in an appropriate manner. The transfer of foodstuffs from one international aircraft to another is only to be permitted if approved by a Biosecurity Officer. For approval, controls would normally include transfer in sealed modules under the direct supervision of a Biosecurity Officer.

9.8.3 All food and quarantine waste removed from international aircraft must be disposed of in a manner approved by Department of Agriculture. Waste must be securely bagged by aircrew and ready for removal by Department of Agriculture personnel. When prohibited foodstuffs are retained on board at a first or intermediate port, the Biosecurity Officer at this port is to ensure that the Biosecurity Officer at the final destination is advised of the aircraft identification, estimated time of arrival and nature of the prohibited material. All persons on board an aircraft subject to quarantine must be instructed that under no circumstances is any used or unused food to be removed from the aircraft other than prescribed above.

9.9 Quarantinable Disease

9.9.1 Human diseases that are listed under the Act as quarantinable diseases are listed on the Department of Health and Aging website:
<http://www.health.gov.au/internet/main/publishing.nsf/Content/health-pubhlth-strateg-quaranti-index.htm>.

GEN 1.4 ENTRY, TRANSIT AND DEPARTURE OF CARGO

1. CUSTOMS REQUIREMENTS CONCERNING CARGO AND OTHER ARTICLES

1.1 Cargo Report

1.1.1 The cargo report is used to report the particulars of all goods (including mail, in-transit and transshipment cargo) that a cargo reporter has arranged to be carried on board regardless of whether the goods will be offloaded in Australia. Private charter flights which are carrying cargo (air freight) are not exempt from these requirements.

1.1.2 The carrier (airline) is required, as the first cargo reporter, to report the full detail of cargo for which they are directly responsible to the Australian Border Force. They are also required to notify the Australian Border Force of any cargo carried on behalf of another cargo reporter and the details of the depot operator who will first receive the cargo after it has been unloaded from the aircraft at a place in Australia. This includes airline mail items (sometimes referred to as 'on company service').

1.1.3 The cargo report must be lodged electronically in the Integrated Cargo System (ICS) at least two hours prior to the latter of: the estimated time of arrival of the aircraft (as indicated on the Impending Arrival Report), or the actual arrival time of the aircraft. If the charter business is not a regular cargo carrier, and does not have the facilities to make a cargo report using the ICS, they are recommended to engage a Freight Forwarder or a bureau to submit the required electronic reports to the ABF.

1.1.4 When a cargo report is submitted showing the cargo has a discharge port as an Australian port, but the destination port is not an Australian port, the ICS recognises that ultimately the cargo is destined for a place outside Australia. The ICS assigns the cargo report transshipment status and will automatically generate a Transshipment Number. A Transshipment Number is a valid Customs Authority Number for the purposes of export and must be quoted in the outwards manifest.

1.2 List of Stores (e.g. narcotic drugs, beer, wine, spirits and tobacco products)

1.2.1 When an aircraft has arrived at an airport in Australia, the operator must report the particulars of the aircraft's stores and of any prohibited goods contained in those stores at the time of arrival to the Australian Border Force via Form B367, Stores and Prohibited Goods Report.
See: www.abf.gov.au/form-listing/forms/b367.pdf

1.2.2 The report of aircraft stores and prohibited goods must be made within three hours of the arrival of the aircraft or before the certificate of clearance is issued, whichever happens first.

1.3 Import Declarations and Carnets

1.3.1 Import declarations are used to clear goods with a value exceeding AUD1000 from ABF control. Import declarations are communicated to Australian Border Force electronically via the Integrated Cargo System (ICS) or by lodgement of a completed import declaration form (B650)-
www.abf.gov.au/form-listing/forms/b650.pdf, at an ABF counter.

1.3.2 A self-assessed clearance declaration must be made for imported goods arriving by air cargo valued not exceeding AUD1,000. Form B650: www.abf.gov.au/form-listing/forms/b650.pdf, can also be used to make this declaration.

1.3.3 Temporarily imported goods subject to a carnet may be cleared without an import declaration. Temporarily imported goods must be re-exported from Australia within the time period specified by the ABF.

1.4 Treatment of Diplomatic and Consular Goods

1.4.1 All air cargo consignments of diplomatic and consular goods require a cargo report. However, an import declaration is not required to be submitted to the Australian Border Force (for diplomatic/consular/mail/pouch/bags).

1.4.2 Most diplomatic and consular goods are exempt from duty and taxes and cost recovery charges provided the goods meet all the Australian Border Force and the DAFF - biosecurity legislative requirements including the *Customs (Prohibited Imports) Regulations 1956* and the *Biosecurity Regulations 2016*. Where prohibited goods are to be imported, permission must be obtained prior to the importations of the goods. Further details are available online:
www.abf.gov.au/importing-exporting-and-manufacturing/prohibited-goods.

1.4.3 The B615 form and other reporting requirements must be provided to the Australian Border Force for the release of privileged imports from customs control.

1.5 Departure Report

1.5.1 The departure report is a prerequisite that must be satisfied before a Certificate of Clearance (CoC) can be granted by the Australian Border Force.

1.5.2 A departure report is a statement made by the pilot or owner of the aircraft, or an agent, to the Australian Border Force providing information concerning the proposed date and time of departure of the aircraft.

1.5.3 The departure report must be lodged electronically in the ICS.

1.5.4 For airlines that co-load/codeshare, a Departure Report is required for each flight number even though it is the same aircraft departing.

1.6 Outwards Manifest

1.6.1 Air cargo being exported from Australia must be reported in the form of an outward manifest. The outwards manifest must specify all goods that were loaded on board the aircraft.

1.6.2 The pilot or owner of the aircraft must provide the outwards manifest electronically, in the ICS, not later than three days after the day of departure of the aircraft.

1.6.3 If a departing aircraft is not carrying any export cargo, a manifest must still be lodged. This manifest states that no cargo was loaded and is called a 'Nil Manifest'.

1.7 Export Reporting

1.7.1 The exporter must lodge an export declaration and obtain a "clear" Export Declaration Number before the cargo may be loaded for export. An export declaration can be communicated by document or electronically through the ICS. An Export Declaration Number is required for the following:

- a. goods requiring a permit (regardless of value);
- b. goods on which a drawback is to be claimed;
- c. customable and excisable goods on which duty/excise has not been paid; and
- d. goods with a value greater than AUD2,000, except exempt goods.

1.7.2 Goods that are except from requiring an Export Declaration include:

- a. personal effects;
- b. pets;
- c. goods with a value of less than AUD2,000;
- d. some goods temporarily imported under section 162A of the *Customs Act 1901*;
- e. Australia Post or diplomatic bags of mail;
- f. Australian aircraft and ships' spares;
- g. military goods of any value that are the property of Australian Government, for use overseas by Australian Defence Forces;
- h. Australian domestic cargo;
- i. containers for the international carriage of cargo and ships' stores.

1.7.3 These goods are reported to ABF by citing an exemption code on the outwards manifest.

1.7.4 A Main Manifest Number is supplied by ABF.

1.8 Certificate of Clearance.

1.8.1 The pilot of an aircraft must not depart from any airport without receiving a Certificate of Clearance from an ABF Officer.

2. BIOSECURITY REQUIREMENTS

2.1 Australia is free from many diseases, pests and weeds which cause serious damage in other parts of the world. Air crew and passengers are required to comply with legislative requirements under the *Biosecurity Act 2015* to help preserve this.

2.2 Imported air cargo of biosecurity interest (such as fruit and vegetables, live plants, seeds, animal, avian and aquatic species or commodities derived from these products) must be reported via the ABF ICS System.

2.3 The relevant type of import declaration is required to be lodged for each imported consignment of biosecurity interest prior to release of cargo.

2.4 The import conditions for cargo of biosecurity interest are outlined in the DAFF - Biosecurity Import Conditions Database (BICON): <https://bicon.agriculture.gov.au/BiconWeb4.0>

2.5 Transport and packaging requirements for live animal, avian and aquatic species are specified in the International Air Transport Association – Live Animal Regulations, available at: www.iata.org/whatwedo/cargo/live-animals/Pages/index.aspx

2.6 The relevant type of import declaration is required to be lodged for each imported consignment of biosecurity interest prior to release of cargo.

2.7 Importers should note that all biosecurity inspections, permits and entries carry a fee for service charge. More information is available at: www.agriculture.gov.au/fees

2.8 **ARMY** - International. Except with the approval of the Department of Agriculture, no member is to convey by air any of the following into Australia:

- a. animals;
- b. plants, fruit seeds and any parts of plants including straw and grass; and
- c. parts of animals such as skin, horns, hooves, hair and feathers.

2.9 **ARMY** - Interstate. Except for fruit intended for consumption as in-flight rations, the Aircraft Captain shall ensure that no fruit or plants are conveyed across Australian state borders.

3. AIR CARGO SECURITY REQUIREMENTS

3.1 The *Aviation Transport Security Act 2004* (ATSA) and the *Aviation Transport Security Regulations 2005* (the Regulations) establish a regulatory framework to safeguard against unlawful interference with aviation and maintain and improve aviation security.

3.2 Supply chain security for air cargo is regulated under the ATSA and the Regulations, which require certain air cargo supply chain industry participants to hold and maintain approved security programs. Operating under the Regulated Air Cargo Agent scheme, the Accredited Air Cargo Agent scheme and the Known Consignor scheme, security programs set out the measures and procedures industry participants need to implement to meet their obligations under the ATSA and Regulations.

3.3 All outbound international air cargo is required to be examined at piece-level by a Regulated Air Cargo Agent or originate from a Known Consignor. Piece-level examination means that each individual box, carton or other item in a shipment must be examined at a deconsolidated level. To originate from a Known Consignor means goods must be produced, packaged, stored, controlled, transported and handled in a manner that ensures their integrity and protects them from unlawful interference from their point of origin through to loading onto an aircraft.

3.4 In order for an item of cargo to be loaded onto an international aircraft, that cargo must be issued with a security declaration from a Known Consignor or Regulated Air Cargo Agent.

3.5 Domestic air cargo must be examined at the piece level by a Regulated Air Cargo Agent, or originate from a Known Consignor and have a security declaration if it is loaded onto aircraft departing any designated or tier 1 security controlled airport. This applies only to aircraft with a seating capacity of 40 persons or more and/or a maximum take-off weight of 20,000KG or more. Closed charter flights are excluded from the domestic air cargo examination requirements. Refer to *Regulation 1.03* of the *Regulations* for the definition of 'closed charter operation'.

3.6 Enquiries around regulatory requirements should be directed to the Transport Security Guidance Centre within the Cyber and Infrastructure Security Centre, Department of Home Affairs (see *GEN 1.1*).

4. ADF - AUSTRALIAN DEFENCE FORCE CARGO

4.1 Returned, Used ADF Owned Equipment

4.1.1 Returned, used ADF owned equipment may be informally cleared at a Department of Home Affairs controlled place by local arrangement.

4.1.2 Verification that inward cargo is in fact returned, used ADF equipment is the responsibility of the Air Movement Section or Unit controlling the equipment. This can be in the form of export manifests or cargo/mail manifests.

4.2 Personal Effects

4.2.1 Personal Effects are to be cleared by a form B534 (Unaccompanied Personal Effects Statement) at the destination airport. Unaccompanied effects are to be clearly described on manifests. Duty/sales tax will be collected where applicable.

4.3 Outwards Cargo

4.3.1 Military goods subject to Regulation 13B of the Customs Prohibited Export Regulations, which will remain the property of the ADF, are exempt from permit requirements. If the goods are to be sold or otherwise disposed of, then export permits are required.

4.3.2 ADF owned equipment, such as computers and cameras, in the possession of ADF personnel that are to be temporarily exported are to be reported on a form B263 (Goods Exported in Passenger Baggage).

5. ADF - FOREIGN MILITARY CARGO

5.1 For military exercises approved by the Australian Government, import and export permits for certain defence goods are exempt from Customs Prohibited Imports and Prohibited Exports Regulation.

5.2 At the first port of entry, an uncoded and legible cargo manifest is to be presented to the Department of Home Affairs officer. An uncoded and legible cargo manifest is to be given to the Department of Home Affairs officer at the last port of departure to ensure the cargo has been exported.

5.3 Other goods subject to import and export controls (e.g. drugs and pharmaceuticals) require permits from the relevant authorities.

5.4 Cargo imported by foreign military aircraft may be subject to examination.

GEN 1.5 AIRCRAFT INSTRUMENTS, EQUIPMENT AND DOCUMENTATION

1. RADIO COMMUNICATION SYSTEM REQUIREMENTS

1.1 The underpinning rule for all radio communication equipment requirements is that an aircraft, in controlled or uncontrolled airspace, must have radio communication systems capable of:

- a. collectively communicating on all frequencies necessary to meet the reporting, broadcast and listening watch requirements under civil aviation legislation, from any point on the route of the flight, including in the event of any diversions; and.
- b. 2-way voice communications; and
- c. communicating on the aeronautical emergency frequency 121.5MHz.

1.2 ADF - Specific radio equipment carriage requirements are specified by the MAO.

2. RADIO NAVIGATION SYSTEM REQUIREMENTS

2.1 **ADF** - The navigation requirements for aeroplane flights are specified by the MAO.

2.2 **ADF** - The navigation requirements for rotorcraft flights are specified by the MAO.

2.3 **Rated Coverages.** The following ranges are quoted for planning purposes. Actual ranges obtained may sometimes be less than these due to facility and site variations (see ERSA). The localiser ranges are for those installations that have been nominated for position fixing at ranges beyond 25NM.

- a. NDB (published in ERSA)
- b. VOR/DME/TACAN:

Aircraft Altitude (FT)	Range (NM)
Below 5,000	60
5,000 to below 10,000	90
10,000 to below 15,000	120
15,000 to below 20,000	150
20,000 and above	180

- c. Localiser:

Aircraft Altitude (FT)	Range (NM)
At 2,000AGL within $\pm 10^\circ$ of course line	25
Below 5,000	30
5,000 and above	50

- d. GBAS course deviation limitation:

For GLS course deviation information see *ERSA Facilities (FAC)* section for each location under the heading RADIO NAVIGATION AND LANDING AIDS.

3. EMERGENCY LOCATOR TRANSMITTER (ELT)

3.1 This section from Airservices Australia AIP not applicable to ADF.

4. AIRBORNE WEATHER RADAR

4.1 This section from Airservices Australia AIP not applicable to ADF.

5. GROUND PROXIMITY WARNING SYSTEM (GPWS)

5.1 This section from Airservices Australia AIP not applicable to ADF.

6. SURVEILLANCE EQUIPMENT

6.1 General requirements and capabilities

6.1.1 ADF - The requirements for the carriage and use of surveillance equipment - including transponders and ADS-B transmitting equipment - are specified by the MAO. Specific Approvals from DASA to use surveillance equipment are listed in the MAOC OPSEC.

6.1.2 ADF - Refer to DASA Advisory Circular 005/16 - Defence Compliance With Civil ADS-B Requirements. Further advice, including advice about installing equipment, can be found in CASA AC 91-23 and on the CASA website.

6.2 Flight without serviceable required surveillance equipment.

6.2.1 Where an aircraft's required surveillance equipment (transponder or ADS-B OUT) is unserviceable, the civil aviation legislation requires that a flight may only take place if:

- a. the flight begins from an aerodrome at which there is no facility for the surveillance equipment to be repaired or replaced;
- b. the flight ends not more than 72 hours after the time the surveillance equipment was found to be inoperative; and
- c. before the flight commences, the pilot in command informs ATS about the unserviceability.

6.2.2 Flights of an aircraft without the required surveillance equipment being serviceable or fitted to the aircraft may experience delays or restrictions to air traffic control clearances. Pilots in command should contact ATC for planning advice before the flight commences.

Note: Aircservices Australia contact number: 03 9235 7550 (recorded line).

6.2.3 If surveillance equipment becomes unserviceable in flight, aircraft may experience delays or ATC assignment of non-optimal cruising levels or routing.

6.3 ADS-B equipment in State Aircraft

6.3.1 State aircraft fitted with non-compliant ADS-B transmitting equipment should set the equipment to output a value of zero for the NUCp, NACp, NIC or SIL. If unable to apply these settings, the ADS-B equipment non-compliance must be detailed in the flight notification. Non-ADS-B equipped state aircraft have equal priority with ADS-B-equipped aircraft.

Note 1: The operation of non-compliant ADS-B equipment can significantly affect and degrade ATS surveillance capability.

Note 2: State aircraft in flight that have not flight planned as above may request operation under the provisions of ENR 1.7 paragraph 3. Cruising Levels - "DUE OPERATIONAL REQUIREMENT".

7. AIRBORNE COLLISION AVOIDANCE SYSTEM (ACAS) / TRAFFIC ALERT AND COLLISION AVOIDANCE SYSTEM (TCAS)

7.1 Overview

7.1.1 Aircraft fitted with a serviceable ACAS/TCAS, and with a crew trained in its use, are permitted to operate that system while in Australian airspace.

7.1.2 Pilots of transponder-equipped aircraft should ensure their transponder is switched to ON/ALT (Mode C) at all times.

Note: TCAS will neither track nor display:

- a. non-transponder-equipped aircraft;
- b. aircraft with an inoperable transponder; or
- c. aircraft operating a Mode A transponder.

7.2 Use of ACAS/TCAS Indicators

7.2.1 **Traffic Advisory (TA).** In the event of a TA, pilots should use all available information to prepare for appropriate action if an RA occurs including:

- a. attempt to establish visual contact; and
- b. change the flight path only if a collision risk is established visually.

Note: RA collision avoidance manoeuvres will not be provided to an aircraft with TA-only mode selected, e.g. during engine failure or operating in known close proximity to other traffic such as approaches to closely spaced parallel runways.

7.2.2 **Resolution Advisory (RA).** In the event of an RA, pilots must:

- a. immediately conform to the RA indication, even if this conflicts with an air traffic control (ATC) instruction, unless doing so would jeopardise the safety of the aircraft;
- b. limit the alterations of the flight path to the minimum extent necessary to comply with the RA; and
- c. notify ATC, as soon as permitted by workload, of any RA which requires a deviation from the current ATC instruction or clearance.

7.3 Responsibility for Separation

7.3.1 Once an aircraft manoeuvres in response to an RA, ATC is not responsible for providing separation between that aircraft and any other aircraft, airspace, terrain or obstruction.

7.3.2 When the conflict is resolved, pilots must:

- a. promptly return to the terms of the latest ATC instruction or clearance and notify ATC of the manoeuvre; or
- b. comply with any amended ATC clearance or instruction issued.

7.3.3 ATC responsibility for separation resumes when separation is re-established after:

- a. the responding aircraft has returned to its assigned level;
- b. the pilot advises ATC that the TCAS manoeuvre is completed; or
- c. the responding aircraft has executed an alternate clearance.

7.4 ADF - ACAS/TCAS Operation and Reporting

7.4.1 **ADF** - When ADF aircraft intend to operate in environments and situations where ACAS may not be practical (e.g. radio silent or reduced separation criteria), policy must be detailed by the MAO.

7.4.2 **ADF** - TCAS Resolution Advisories (RA) involving civil and ADF aircraft, or which occur in civil airspace, must be reported via Sentinel to DFSA as they are treated as Routine Reportable Matters by the Australian Transport Safety Bureau (ATSB). Other ADF TCAS RA are to be reported in accordance with single service and MAO requirements.

7.5 High Vertical Rate (HVR) Encounters

7.5.1 A TCAS Resolution Advisory (RA) may result from having a high vertical rate when approaching an assigned altitude or flight level when another aircraft is maintaining, or approaching, an adjacent altitude or flight level. To avoid RAs in these circumstances, the pilot of the climbing or descending aircraft should, where practicable, reduce the vertical rate to less than 1,500 FPM when within the last 1,000FT of the assigned altitude or flight level, unless otherwise directed by ATC.

Note 1: Pilots are not required to modify vertical speed for every level-off. This is not necessary and would introduce a significant increase in pilot workload.

Note 2: Pilots may become aware of the presence of an adjacent aircraft by several means, including:

- a. *visual acquisition;*
- b. *information provided by ATC; or*
- c. *TCAS Traffic Advisory (TA).*

8. AREA NAVIGATION SYSTEMS APPROVAL AND OPERATIONS

8.1 Requirements, advice and information on area navigation, PBN and GNSS aspects can also be found on the CASA website at:
www.casa.gov.au/airspace/standard-page/cns-atm-navigation.

8.1.1 Area navigation systems rely on data in the navigation database to be current, valid and correct for the navigation system to provide the correct information. Navigation databases should be regularly checked for integrity and if any discrepancy in the data is discovered, report the discrepancy as soon as practicable to the database provider.

Note: Errors may occur in navigation databases from time to time. Pilots should subscribe to any alerting services offered by the navigation database provider to receive notifications of any navigation database errors.

8.1.2 **ADF** - Specific Approvals from DASA to conduct RNP-AR procedures are listed in the MAOC OPSPEC.

8.2 Notification of Failure or Operation Outside of Tolerance

8.2.1 Pilots using area navigation systems for navigation must notify ATC:

- a. about navigation equipment failure; or
- b. of operations of the equipment outside the approved tolerances; or
- c. for inertial systems, the times between up-dates, or from departure, exceeding three (3) hours for single units or five (5) hours for multiple units for flights in controlled airspace other than OCA, and five (5) hours for a single unit or twelve (12) hours for multiple units for flights in OCA.

Note: ATC may discontinue applying certain area navigation standards after receipt of the advice.

9. RVSM APPROVAL AND OPERATIONS

9.1 ADF - RVSM is an ICAO standard, which allows the use of 1000FT separation between RVSM-approved aircraft operating from FL290 to FL410 inclusive. In Australia, RVSM is applied in accordance with the ICAO standard. Specific Approvals from DASA to conduct RVSM are listed in the MAOC OPSEC.

10. AOC TO BE CARRIED ON BOARD

10.1 This section from Airservices Australia AIP not applicable to ADF.

**GEN 1.6 SUMMARY OF NATIONAL REGULATIONS AND
INTERNATIONAL AGREEMENT/CONVENTIONS**

1. This section from Airservices Australia AIP not applicable to ADF.



**GEN 1.7 DIFFERENCES FROM ICAO STANDARDS, RECOMMENDED
PRACTICES AND PROCEDURES**

1. The differences that exist between Australian national aviation regulations and those specified by ICAO as Standards and Recommended Practices (SARPS) are identified on the Airservices Australia website at: www.airservicesaustralia.com/aip/aip.asp
Read and agree to the Copyright Notice, then click on the current "Differences from ICAO Standards, Recommended Practices and Procedures" link.



GEN 2.1 MEASURING SYSTEM, AIRCRAFT MARKINGS, HOLIDAYS

1. UNITS OF MEASUREMENT

1.1 Units of measurement to be used in airways operations and air-ground communications are as follows:

Measurement	Units
Distances used in navigation (generally in excess of 2NM*)	nautical miles and tenths*
Short distances	metres
Altitudes, elevations and heights	feet
Horizontal speed, including wind speed	knots
Vertical speed	feet per minute
Wind direction for runway operations	degrees magnetic
Wind direction except for runway operations	degrees true
Visibility, including runway visual range	kilometres or metres
Altimeter setting	hectopascals
Temperature	degrees celsius
Weight (Mass) Metric	tonnes or kilograms
Time	hours and minutes

*Note: * Miles must be read as meaning nautical miles unless otherwise stated. The word "nautical" may be omitted from air-ground communications.*

1.2 An aircraft which is temporarily unable to use these units must so advise and request the ground station to transmit in units usable by the aircraft.

2. TIME SYSTEM

2.1 **Coordinated Universal Time (UTC)** is used for aviation.

2.2 **Date and time** is indicated in a combination of the date and time in a single six figure group. However, a 10 figure group comprising the year, month, date, hours and minutes is used for NOTAM and SUPs. This is reduced to an eight figure group (nil year) for SPFIB.

Note: When the days of the week are referenced in a NOTAM, the day refers to the local day with timings in UTC i.e. SUN 2300-0300 refers to SAT 2300 UTC - SUN 0300 UTC.

3. GEODETIC REFERENCE DATUM

3.1 All published geographical coordinates are expressed in term of the World Geodetic System – 1984 (WGS-84). Most geographical coordinates have been surveyed; however, those geographical coordinates that have been mathematically derived are indicated by an asterisk.

3.2 Geographical coordinates published in AIP documents/charts and NOTAM are expressed as degrees, minutes, seconds (if required), and if more precision is required, tenths/hundredths of a second with the cardinal point last; e.g. 3635S 14626E or 050721.2S 0652522.6E.

4. PUBLIC HOLIDAYS

4.1 Public Holidays

NATIONAL

New Year's Day	01 January
Australia Day	26 January
Good Friday	Friday before Easter
Easter Monday	Monday after Easter Sunday
ANZAC Day	25 April
King's Birthday	According to the published date for the relevant State/Territory
Christmas Day	25 December
Boxing Day	26 December

Note: When New Year's Day, Australia Day, Christmas Day and Boxing Day falls on a Saturday or Sunday, the next following working day is declared the public holiday. In this case, both the actual day and the following declared public holiday are considered to be public holidays.

4.2 Some services may be affected on public holidays. Personnel should check NOTAM and/or contact the relevant aerodrome owner/operator.

4.3 Airspace specified as active or not active on public holidays refers only to the National holidays as listed in paragraph 4.1. Any other holidays affecting activation will be specified by NOTAM.

5. ARMY - AIRCRAFT MARKINGS

5.1 Army HQ is to allot each aircraft a number which is to apply throughout the service life of that aircraft.

5.2 Unit badges or insignia are only to be applied to Army aircraft with the approval of:
COMD AVN SPT GP.

GEN 2.2 DEFINITIONS AND ABBREVIATIONS

1. DEFINITIONS

ACAS (Airborne Collision Avoidance System): An aircraft system based on secondary surveillance radar (SSR) transponder signals which operates independently of ground-based equipment to provide advice to the pilot on potential conflicting aircraft that are equipped with SSR transponders.

Accelerate-Stop Distance Available: The takeoff run available plus the length of -suitable stopway available (if stopway is provided).

Active LAHSO Runway: The runway used during LAHSO for arriving aircraft issued with a hold short instruction.

Administering Authority: With respect to a Danger Area or Military Operating Area this is the agency nominated to exercise the conditions specified for the area and, where authorised, the Air Traffic Service provider for that area. See also Controlling Authority.

ADF Aeronautical Information Package: A series of publications issued by or with the authority of the Director Capability Management - Air Force and containing aeronautical information or instructions of a lasting character essential to ADF air operations.

ADS-B (Automatic Dependent Surveillance - Broadcast): A means by which aircraft, aerodrome vehicles and other objects can automatically transmit or receive data such as identification, position and additional data, as appropriate, in a broadcast mode via a data link.

ADS-C Agreement: A reporting plan which establishes the conditions of ADS-C data reporting (i.e. data required by the air traffic services unit and frequency of ADS-C reports which have to be agreed to prior to the provision of the air traffic services).

Aerodrome: An area of land or water (including any buildings, installations and equipment), the use of which as an aerodrome is authorised under the regulations, being such an area intended for use wholly or partly for the arrival, departure and movement of aircraft. *Civil Aviation Act 1988 (Cth)*.

Aerodrome Beacon: An aeronautical beacon used to indicate the location of an aerodrome from the air.

Aerodrome Control Service: ATC service for aerodrome traffic.

Aerodrome Control Tower: A unit established to provide ATC service to aerodrome traffic.

Aerodrome Elevation: The elevation of the highest point of the landing area.

Aerodrome Meteorological Minima (Ceiling and Visibility Minima): The minimum heights of cloud base (ceiling) and minimum values of visibility which are prescribed in pursuance of *CASR Part 91* for the purpose of determining the usability of an aerodrome either for takeoff or landing.

Aerodrome Meteorological Office: An office designated to provide meteorological service for aerodromes serving international air navigation.

Aerodrome Proprietor: Any Owner, Licensee, Authority, Corporation, or any other body which has a legal responsibility for a particular aerodrome.

Aerodrome Reference Point (ARP): The designated geographical location of an aerodrome.

Aerodrome Traffic: All traffic on the manoeuvring area of an aerodrome, and all aircraft flying in, entering, or leaving the traffic circuit.

Aerodrome Traffic Circuit: The specified path to be flown by aircraft flying in, entering, or leaving the traffic circuit.

Note: At a controlled aerodrome, an aircraft is in the traffic circuit when it is within the CTR and established on a leg of the circuit.

Aeronautical Beacon: An aeronautical ground light visible at all azimuths, either continuously or intermittently, to designate a particular point on the surface of the earth.

Aerodrome Traffic Zone: An airspace of defined dimensions established around an aerodrome for the protection of aerodrome traffic.

Aeronautical Information Circular (AIC): A notice containing information that does not qualify for the origination of a NOTAM, or for inclusion in the AIP, but which relates to flight safety, air navigation, technical, administrative or legislative matters.

Aeronautical Information Package: (see ADF Aeronautical Information Package.)

Aeronautical Information Publication (AIP): A publication issued by or with the authority of a State and containing aeronautical information of a lasting character essential to civil air navigation.

AIP Supplement (SUP): Temporary changes to the information contained in the AIP which are published by means of special pages.

Aeroplane: A power driven heavier-than-air aircraft, deriving its lift in flight chiefly from aerodynamic reactions on surfaces which remain fixed under given conditions of flight.

Airborne Collision Avoidance System (ACAS): An aircraft system based on secondary surveillance radar (SSR) transponder signals which operates independently of ground-based equipment to provide advice to the pilot on potential conflicting aircraft that are equipped with SSR transponders.

Aircraft: Any machine that can derive support in the atmosphere from the reactions of the air other than the reactions of the air against the earth's surface.

Aircraft Address: A unique combination of 24 bits available for assignment to an aircraft for the purpose of air-ground communications, navigation and surveillance. Expressed as a six character hexadecimal code.

Aircraft Captain: The captain is a qualified first pilot on type who has been judged by the CO to be suitable for regular appointment as an aircraft captain for a specified range of operational and other tasks relevant to that unit and aircraft type.

Aircraft Classification Number (ACN): A number expressing the relative effect of an aircraft on a pavement for a specific standard sub-grade category.

Aircraft Identification: An identification of up to seven (7) alpha-numeric characters used to identify the aircraft in flight notifications and in Mode S transponders/ADS-B transmitters.

Note: The Aircraft Identification entered into the Mode S Transponder, or ADS-B Transmitter, must match the Aircraft Identification entered into Item 7 of the Flight Notification or, when no flight notification has been filed, the aircraft registration. Hyphens or symbols may not be used within the identification.

Aircraft Parking Position Taxiway: A portion of an apron designated as a taxiway and intended to provide access to aircraft parking positions only.

Air-Ground Communications: Two way communications between aircraft and stations on the surface of the earth.

AIRMET Information: Information issued by a meteorological watch office concerning the occurrence or expected occurrence of specified en route weather phenomena which may affect the safety of low-level aircraft operations and which was not already included in the forecast issued for low-level flights in the flight information region concerned or sub-area thereof.

Air-Report (AIREP): A report from an aircraft in flight prepared in conformity with requirements for position and operational and/or meteorological reporting.

Airspace Release: A defined volume of airspace normally under the jurisdiction of one controlling or administering authority that is temporarily released, by common agreement, for exclusive use of another.

Airspace Speed Limitation: A speed limit specified for a particular class of airspace.

Air Taxiing: Movement of a helicopter/VTOL above the surface of an aerodrome, normally in ground effect and at a speed normally less than 20KT.

Air Traffic Control Clearance: Authorisation for aircraft to proceed under conditions specified by an ATC Unit.

Note: For convenience, the term "Air Traffic Control Clearance" is normally abbreviated to "Clearance" when used in appropriate context.

Air Traffic Control Instructions: Directives issued by ATC for the purpose of requiring a pilot to take a specific action.

Air Traffic Control Service: A service provided for the purpose of:

- a. preventing collisions:
 - 1) between aircraft; and
 - 2) on the manoeuvring area between aircraft and obstructions; and
- b. expediting and maintaining an orderly flow of air traffic.

Air Traffic Control Speed Restriction: An ATC traffic management speed or an ATC-issued speed control instruction.

Air Traffic Service (ATS): A generic term meaning variously, flight information service, alerting service, air traffic advisory service, ATC service (area control service, approach control service or aerodrome control service).

Air Transit: The airborne movement of a helicopter that is:

- a. for the expeditious transit from one place within an aerodrome to another place within the aerodrome;
- b. at or below 100FT above the surface; and
- c. at speeds greater than those used in air taxiing.

AIRAC: An acronym (aeronautical information regulation and control) signifying a system aimed at advance notification based on common effective dates, of circumstances that necessitate significant changes in operating practices.

Airspace Determination: An assessment conducted by Airservices Australia to determine the impact of a HLS on other airspace users.

Airspace Reservation: A defined volume of airspace normally under the jurisdiction of one aviation authority and temporarily reserved, by common agreement, for the exclusive use of another.

Airways Clearance: A clearance, issued by ATC, to operate in controlled airspace along a designated track or route at a specified level to a specified point or flight planned destination.

Alerted See-and-Avoid: A procedure where flight crew, having been alerted to the existence and approximate location of other traffic in their immediate vicinity, seek to sight and avoid colliding with those known aircraft.

Alerting Post: An agency designated to serve as an intermediary between a person reporting an aircraft in distress and a rescue coordination centre.

Alerting Service: A service provided to notify appropriate organisations regarding aircraft in need of search and rescue aid, and to assist such organisations as required.

Alternate Aerodrome: An aerodrome to which an aircraft may proceed when it becomes either impossible or inadvisable to proceed to or to land at the aerodrome of intended landing.

Altimeter Setting: A pressure datum which when set on the sub-scale of a sensitive altimeter causes the altimeter to indicate vertical displacement from that datum. A pressure-type altimeter calibrated in accordance with Standard Atmosphere may be used to indicate altitude, height or flight levels, as follows:

- a. when set to QNH or Area QNH it will indicate altitude;
- b. when set to Standard Pressure (1013.2HPA) it may be used to indicate flight levels.

Altitude: The vertical distance of a level, a point or an object, considered as a point, measured from mean sea level.

Approach Control Service: ATC service for arriving or departing flights.

Approach Control Unit: A unit established to provide air traffic control service to controlled flights arriving at, or departing from, one or more aerodromes.

Approach Sequence: The order in which two or more aircraft are cleared to approach to land at the aerodrome.

Apron: A defined area on a land aerodrome, intended to accommodate aircraft for purposes of loading or unloading passengers, mail, cargo, fuelling, parking or maintenance.

Apron Service: A traffic regulatory and information service provided to aircraft using the apron area of an aerodrome.

Apron Taxiway: A portion of a taxiway system located on an apron and intended to provide a through taxi route across the apron.

Area Control Service: ATC service for controlled flights in control areas.

Area Navigation: A method of navigation which permits aircraft operation on any desired flight path within the coverage of ground or space-based navigation aids, or within the limits of the capability of self-contained aids, or a combination of these.

Area Navigation Route: An ATS route established for the use of aircraft capable of employing area navigation.

Area Navigation Systems: Navigation systems supporting area navigation.

Area QNH: A forecast altimeter setting which is representative of the QNH of any location within a particular area.

Area VHF: The appropriate FIA VHF channel for a location.

ATS Route: A specified route designed for channelling the flow of traffic as necessary for the provision of air traffic services.

ATS Surveillance Service: Term used to indicate an air traffic service provided directly by means of an ATS surveillance system.

ATS Surveillance System: A generic term meaning variously, ADS-B, PSR, SSR or any comparable ground based system that enables the identification of aircraft

Note: A comparable ground-based system is one that has been demonstrated, by comparative assessment or other methodology, to have a level of safety and performance equal to, or better than, monopulse SSR.

Automatic Dependent Surveillance - Broadcast (ADS-B): A means by which aircraft, aerodrome vehicles and other objects can automatically transmit or receive data such as identification, position and additional data, as appropriate, in a broadcast mode via a data link.

Automatic Dependent Surveillance - Contract (ADS-C): A means by which the terms of an ADS-C agreement will be exchanged between the ground system and the aircraft, via a data link, specifying under what conditions ADS-C reports would be initiated, and what data would be contained in reports.

Note: The abbreviated term "ADS contract" is commonly used to refer to ADS event contract, ADS demand contract, ADS periodic contract or an emergency mode.

Automatic Terminal Information Service (ATIS): The provision of current, routine information to arriving and departing aircraft by means of continuous and repetitive broadcasts during the hours when the unit responsible for the service is in operation.

Aviation Reference Number (ARN): A unique identifier assigned to a person by CASA for the purposes of CASA records.

Base Turn (Instrument Approach): A turn executed by the aircraft during the initial approach between the end of the outbound track and the beginning of the intermediate or final approach track. The tracks are not reciprocal.

Note: Base turns may be designated as being made either in level flight or while descending, according to the circumstances of each individual procedure.

Blanket Clearance: A pre-arranged clearance originated for specific activities or events and specified in a letter of agreement.

Blind Transmission: A transmission from one station to another station in circumstances where two-way communication cannot be established, but where it is believed that the called station is able to receive the transmission.

Block Level: A section of airspace with specified upper and lower limits on a specified track, in which cleared aircraft are permitted to manoeuvre.

Break-out Procedure(s): Immediate evasive manoeuvres, which are performed on instruction by air traffic control.

Note: In the context of simultaneous parallel operations, break-out procedures are used to direct a threatened aircraft and a deviating aircraft away from each other.

Briefing: The act of giving in advance, specific pre-flight instructions or information to aircrew.

Broadcast: A transmission of information relating to air navigation for which an acknowledgement is not expected.

Captain: The person responsible for the operation and safety of the aircraft during a flight.

Caution: Non-compliance with the detailed policy or procedure may result in reduction of safety margins.

Ceiling: The height above the ground or water of the base of the lowest layer of cloud below 20,000FT covering more than one-half of the sky.

GENSAR: An automated centralised SARTIME database software package used by ATS to manage SARTIMES.

Centre: A generic callsign which can include Air Traffic Control, Advisory, Flight Information and Alerting services, depending on the classification of airspace in which the service is provided.

Certified Aerodrome: A place that is certified as an aerodrome under the Civil Aviation Safety Regulations.

Circling Approach: An extension of an instrument approach procedure which provides for visual circling of the aerodrome prior to landing.

Clearance Expiry Time: A time specified by an air traffic control unit at which a clearance ceases to be valid.

Clearance Limit: The point to which an aircraft is granted an air traffic control clearance.

Clearway: A defined rectangular area on the ground or water under the control of the appropriate authority, selected or prepared as a suitable area over which an aeroplane may make a portion of its initial climb to a specified height.

Closely spaced runways: Runways that are parallel or near-parallel and spaced less than 1,525M but not less than 1,035M apart.

Collocated (Navigation) Aids: En route way-points or navigation aids that are within 600M of each other.

Common Traffic Advisory Frequency (CTAF): A designated frequency on which pilots make positional broadcasts when operating in the vicinity of a non-controlled aerodrome or within a Broadcast Area.

Communicable Diseases: Communicable diseases include cholera, typhus (epidemic), smallpox, yellow fever, plague, and such other diseases as the contracting States shall from time to time decide to designate.

Community Service Flight (CSF): A flight that

- a. involves:
 - 1) the transport of one or more individuals (a patient) to a destination for the purpose of each such individual receiving non-emergency medical treatment or services at the destination; or
 - 2) the transport of a patient from a destination mentioned in *para (i)*. (the treatment destination) to another treatment destination; or
 - 3) the transport of a patient from a treatment destination:
 - i back to a place from which the patient departed for a treatment destination; or
 - ii to a destination at which the patient resides; and
- b. is provided to a patient, and any person who accompanies the patient to provide support and assistance, without a charge being made to any of those persons for their carriage; and
- c. medical treatment is not provided on board the aircraft for the flight, other than the administering of medication or in response to an unexpected medical emergency; and
- d. is coordinated, arranged or facilitated by an entity for a charitable purpose or community service purpose.

Company Operations Representative: The representative of an operating agency who is authorised to act in the capacity of liaison officer between ATC and the operating agency in respect of the control of an aircraft of that agency.

Conditional Route (CDR): An ATS route or portion thereof which can be planned and used under specified conditions.

Contaminated Runway: A runway that has more than 25% of the runway surface area within the required length and width being used covered by:

- a. water, or slush, more than 3mm deep; or
- b. loose snow more than 20mm deep; or
- c. compacted snow or ice, including wet ice.

Note: A contaminated runway report should identify the type of contaminant using the relevant runway surface condition descriptor (most commonly 'standing water' in Australia), and if possible and relevant – the extent of contamination. 'CONTAMINATED RUNWAY' is not normally used in radiotelephony.

Continuous Descent Final Approach (CDFA): A technique, consistent with stabilised approach procedures, for flying the final approach segment of a non-precision instrument approach procedure as a continuous descent, without level-off, from an altitude/height at or above the final approach fix altitude/height to a point approximately 50FT above the landing runway threshold or the point where the flare manoeuvre should begin for the type of aircraft flown.

Control Area (CTA): A controlled airspace extending upwards from a specified limit above the earth.

Control Zone (CTR): A controlled airspace extending upwards from the surface of the earth to a specified upper limit.

Controlled Aerodrome: An aerodrome at which ATC service is provided to aerodrome traffic.

Controlled Airspace: Airspace of defined dimensions within which ATC service is provided in accordance with the airspace classification.

Controlled Flight: Any flight which is subject to an air traffic control clearance.

Controller Pilot Data Link Communications (CPDLC): A means of communication between controller and pilot using data link for ATC communications.

Controlling Authority:

- a. With respect to airspace classifications, this is the Air Traffic Service provider for that area.
- b. With respect to Restricted Areas, this is the agency nominated to exercise the conditions of entry and, where authorised, the Air Traffic Service provider for that area. See also *Administering Authority*.

CPDLC message: Information exchanged between an airborne system and its ground counterpart. A CPDLC message consists of a single message element or a combination of message elements conveyed in a single transmission by the initiator.

CPDLC Message Set: A list of standard message elements and free text message elements.

Crossing Tracks: Tracks that intersect at or between 45° and 135°.

Cruise Climb: An aeroplane cruising technique resulting in a nett increase in altitude as the aeroplane weight decreases.

Cruising Level: A level maintained during a significant portion of a flight.

Current Flight Plan: The flight plan that reflects changes to the filed flight plan, if any, by subsequent ATC clearances.

Danger Area: An airspace of defined dimensions within which activities dangerous to the flight of aircraft may exist at specified times.

Day: The period between the beginning of morning civil twilight (first light) and the end of evening civil twilight (last light).

Dead Reckoning (DR) Navigation: The estimating or determining of position by advancing an earlier known position by the application of direction, time and speed data.

Decision Altitude/Height (DA/H): A specified altitude or height in a 3D instrument approach operation at which a missed approach must be initiated if the required visual reference to continue the approach has not been established.

Note 1: DA is referenced to mean sea level and DH is referenced to the threshold elevation.

Note 2: The required visual reference means that section of the visual aids or of the approach area which should have been in view for sufficient time for the pilot to have made an assessment of the aircraft position and rate of change of position, in relation to the desired flight path. In Category III operations with a decision height the required visual reference is that specified for the particular procedure and operation.

Defined Point After Takeoff (DPATO): The point within the takeoff and initial climb phase before which the helicopter's ability to continue the flight safely, with one engine inoperative, is not assured and a forced landing may be required.

Density Height: An atmospheric density expressed in terms of height which corresponds to that density in the Standard Atmosphere.

Dependent Parallel Approaches: Simultaneous instrument approaches to parallel or near-parallel instrument runways where ATS surveillance system separation minima between aircraft on adjacent extended runway centrelines are prescribed.

Distance Measuring Equipment (DME): Equipment which measures in nautical miles, the slant range of an aircraft from the selected DME ground station.

DME Distance: The slant range from the source of a DME signal to the receiving antenna.

Domestic Flight: A flight between two points within the Australian FIR.

Dry Runway: A runway that is free of visible moisture and not contaminated within the area intended to be used.

East Coast SSR Coverage: The area of Australia east-coast secondary surveillance radar (SSR) coverage within approximately 200NM of a line Cairns - Brisbane - Sydney - Melbourne - Adelaide.

Elevation: The vertical distance of a point or a level, on or affixed to the surface of the earth, measured from mean sea level.

Emergency Fuel: The term used to describe a situation when the calculated usable fuel predicted to be available upon landing at the nearest aerodrome where a safe landing can be made is less than the final fuel reserve for the flight.

Note: The emergency fuel declaration is a distress message.

Emergency Phases:

- a. Uncertainty Phase: A situation wherein uncertainty exists as to the safety of an aircraft and its occupants.
- b. Alert Phase: A situation wherein apprehension exists as to the safety of an aircraft and its occupants.
- c. Distress Phase: A situation wherein there is reasonable certainty that an aircraft and its occupants are threatened by grave and imminent danger or require immediate assistance.

Equivalent Single Isolated Wheel Load: The equivalent load that would be imposed on a pavement by a single wheel if any wheel group on an aircraft were replaced by a single wheel using the same tyre pressure.

Essential Radio Navigation Service: A radio navigation service whose disruption has a significant impact on operations in the affected airspace or aerodrome.

Estimate: The time at which it is estimated that an aircraft will be over a position or over the destination.

Estimated Elapsed Time (EET): The estimated time required to proceed from one significant point to another.

Estimated Off Block Time: The estimated time at which the aircraft will commence movement associated with departure.

Estimated Time of Arrival (ETA): For IFR flights, the time at which it is estimated that the aircraft will arrive over that designated point, defined by reference to navigation aids, from which it is intended that an instrument approach procedure will be commenced, or, if no navigation aid is associated with the aerodrome, the time at which the aircraft will arrive over the aerodrome. For VFR flights, the time at which it is estimated that the aircraft will arrive over the aerodrome.

Expected Approach Time (EAT): The time at which ATC expects that an arriving aircraft, following a delay, will leave the holding fix to complete its approach for a landing.

Note: The holding fix referred to in the EAT is that shown on the instrument approach chart from which the instrument approach is prescribed to commence.

Filed Flight Plan (FPL): The latest flight plan as submitted by the pilot, an operator or a designated representative for use by ATS units.

Final Approach: That part of an instrument approach procedure which commences at the specified final approach fix or point, or where such a fix or point is not specified:

- a. at the end of the last procedure turn, base turn or inbound turn of a racetrack procedure, if specified; or
- b. at the point of interception of the last track specified in the approach procedure; and
- c. ends at a point in the vicinity of an aerodrome from which a landing can be made, or a missed approach is initiated.

Final Approach Altitude: The specified altitude at which final approach is commenced.

Final Approach Course: Where the aircraft is aligned with the runway centreline and established on the same lateral navigational guidance as the GLS approach procedure.

Final Approach Fix (FAF): A specified point on a non-precision instrument approach which identifies the commencement of the final segment.

Final Approach Point (FAP): A specified point on the glide path of a precision instrument approach which identifies the commencement of the final segment.

Note: The FAP is co-incident with the FAF of a localiser based non-precision approach.

Final Approach Segment: That segment of an instrument approach procedure in which alignment and descent for landing are accomplished.

Final Approach and Take off Area (FATO): A defined area over which the final phase of the approach manoeuvre to hover or landing is completed and from which the take off manoeuvre is commenced. Where the FATO is to be used by performance Class 1 helicopters, the defined area includes the rejected take off area available.

Final Leg: The path of an aircraft in a straight line immediately preceding the landing (alighting) of the aircraft.

Fix: A geographical position of an aircraft at a specific time determined by visual reference to the surface, or by navigational aids.

Flight crew member: A licensed crew member charged with duties essential to the operation of an aircraft during a flight duty period.

Flight Data: Data regarding the actual or intended movement of an aircraft, normally presented in coded or abbreviated form.

Flight File: A file stored on the NAIPS system which contains stored briefings, or a stored flight notification. Flight files are owned by pilots and/or operators, and updated at their request.

Flight Following: The provision of an ongoing Surveillance Information Service (SIS).

Flight Information: Information useful for the safe and efficient conduct of flight, including information on air traffic, meteorological conditions, aerodrome conditions and airways facilities.

Flight Information Area (FIA): An airspace of defined dimensions, excluding controlled airspace, within which flight information and SAR alerting services are provided by an ATS unit.

Note: FIAs may be sub-divided to permit the specified ATS unit to provide its services on a discrete frequency or family of frequencies within particular areas.

Flight Information Region (FIR): An airspace of defined dimensions within which flight information service and SAR alerting service are provided.

Flight Information Service (FIS): A service provided for the purpose of giving advice and information useful for the safe and efficient conduct of flights.]

Flight Level (FL): A surface of constant atmospheric pressure which is related to a specific pressure datum, 1013.2HPA and is separated from other such surfaces by specific pressure intervals.

Flight Note: Details of the route and timing of a proposed flight provided by the aircraft captain of an aircraft, which is other than notification submitted to Airservices Australia, and which is required to be left with a person who could be expected to notify appropriate authorities in the event that the flight becomes overdue.

Flight Notification (within Australian FIR): Specified information provided to air traffic services units, relative to the intended flight or portion of flight of an aircraft.

Flight Plan: Specified information relative to an intended flight or portion of a flight of an aircraft.

Note 1: The term flight plan may be prefixed by the words “preliminary”, “filed”, “current” or “operational” to indicate the context and different stages of a flight.

Note 2: When the word “message” is used as a suffix to this term, it denotes the content and format of the flight plan data as transmitted.

Flight Plan Data: Data selected from the flight plan for purposes of processing, display or transfer.

Flight Path Monitoring: The use of ATS surveillance systems for the purpose of providing aircraft with information and advice relative to significant deviations from nominal flight path including deviations from terms of their air traffic control clearances.

Note: Some applications may require a specific technology e.g. RADAR, to support the function of flight path monitoring.

Flight Procedure Authorisation (FPA): Authorisations which allow a pilot holding a Private IFR rating to use additional types of navigation aids as well as night flying, instrument approaches and instrument departures.

Flight Service Unit: A unit established to provide flight information and SAR alerting service for the safe and efficient conduct of a flight within part of a FIR.

Flight Status: An indication of whether a given aircraft requires special handling by air traffic services units or not.

Flight Visibility: The visibility forward from the cockpit of an aircraft in flight.

Flow Control: Measures designed to adjust the flow of traffic into given airspace, along a given route, or bound for a given aerodrome, so as to ensure the most efficient utilisation of the airspace or aerodrome.

Flying Training Area: An airspace of defined dimensions within which flying training is conducted. An airspace may be designated as a General Flying Training Area, an Instrument Flying Training Area, a Low Flying Training Area, an Aerobatic Flying Training Area or a Jet Flying Training Area as appropriate. (When justified, a flying training area may also be designated as a Danger Area or Restricted Area).

Forecast: A statement of expected meteorological conditions for a specified period, and for a specified area or portion of airspace.

Formation: Two or more aircraft flown in close proximity to each other and operating as a single aircraft with regard to navigation, position reporting and control.

Free Text Message Element: Part of a message that does not conform to any standard message element in the PANS-ATM (DOC 4444).

Glide Path (GP): A descent profile determined for vertical guidance during a final approach.

Global Navigation Satellite System (GNSS): A satellite-based radio navigation system that uses signals from orbiting satellites to determine precise position and time.

Note: While the term "GNSS" covers a variety of systems such as GPS, GLONASS, Galileo etc, Australia requires the use of GPS for aviation purposes.

Global Positioning System (GPS): A GNSS constellation operated by the United States Government.

Gross Weight: The weight of an aircraft together with the weight of all persons and goods (including fuel) on board the aircraft at that time.

Ground Based Augmentation System (GBAS): An augmentation system in which the user receives augmentation information directly from a ground-based transmitter.

Ground Based Augmentation System (GBAS) Landing System (GLS): A system for approach and landing operations using a GBAS, as the primary navigational reference.

Ground Based Navigation Aid means NDB, VOR, DME.

Ground Taxiing: The movement of a helicopter under its own power and on its undercarriage wheels.

Ground Visibility: The visibility at an aerodrome, as reported by an accredited observer.

Hazardous Conditions: Meteorological conditions which may endanger aircraft or adversely affect their safe operation, particularly those phenomena associated with volcanic ash cloud and thunderstorms - icing, hail and turbulence.

Head of State: Heads of State or of Government, or other selected dignitaries on official visits to Australia (as provided by Department of Prime Minister and Cabinet Protocol and International Visits Branch), or the personal transport of the Governor-General or the Prime Minister.

Heading (HDG): The direction in which the longitudinal axis of an aircraft is pointed, usually expressed in degrees from North (true, magnetic, compass or grid).

Height: The vertical dimension of an object.

Height: The vertical distance of a level, a point or an object considered as a point, measured from a specified datum.

Height Above Aerodrome (non-precision approach or circling) (HAA): The height of the Minimum Descent Altitude above the published aerodrome elevation.

Height Above Threshold (precision approach) (HAT): The height of the Decision Altitude above the threshold elevation.

Helicopter: A heavier than air aircraft supported in flight by the reaction of the air on one or more normally power-driven rotors on substantially vertical axes.

Helicopter Access Corridor: A corridor wholly within controlled airspace designed for the exclusive use of helicopters in VMC. The extent and alignment of the corridor is related to and delineated by prominent geographical / topographical features.

Helicopter Destination Safety Height (HDSH): A safety height based on the criteria of the highest obstacle within the HDSH effective area (HDSHEA) plus the altitude tolerance (refer to GEN 3.3 [Section 4.2](#))

Helicopter DSH Effective Area (HDSHEA): DSHEA is an area of 3NM radius centred on the approved light source for an unaided approach at the destination.

Helicopter Landing Site (HLS): A place that is used as an aerodrome for the purposes of the landing and taking-off of helicopters.

Helicopter Lane: A lane, outside controlled airspace, designed for use by helicopters to facilitate traffic flow.

Helicopter Movement Area: The movement area for helicopters is that part of an aerodrome that can safely be used for the hovering, taxiing, takeoff and landing of helicopters and consists of the manoeuvring area and aprons, but excluding those areas reserved for unrestricted use by the general public.

Helicopter Reference Point (HRP): The designated location of a heliport or a landing location.

Helideck: An area intended for use wholly or partly for the arrival or departure of rotorcraft on a ship, or a floating or fixed structure on water.

High Capacity Aircraft: An aircraft that is certified as having a maximum seating capacity exceeding 38 seats or a maximum payload exceeding 4,200KG.

Highest Usable Level: The highest level available to an aircraft below an active Restricted Area or Restricted Airspace that will provide safe vertical separation from the activity in that area.

Holding Bay: A defined area where aircraft can be held, or bypassed, to facilitate efficient surface movement of aircraft.

Holding Fix: A specified location identified by visual or other means in the vicinity of which the position of an aircraft in flight is maintained in accordance with ATC instructions.

Holding Procedure: A predetermined manoeuvre which keeps an aircraft within a specified airspace whilst awaiting further clearance.

Hold Short Line/Lights: A line marked across a runway, with associated lights, in accordance with the requirements of FIHA AD 1.1, at which landing aircraft must stop when required during Land and Hold Short Operations (LAHSO).

Hospital Aircraft: (see Medical Flight).

Hot Spot: A location on an aerodrome movement area with a history or potential risk of collision or runway incursion, and where heightened attention by pilots/drivers is necessary.

Identification: The situation which exists when the position indication of a particular aircraft is seen on a situation display and positively identified by ATC.

IFR Flight: A flight conducted in accordance with the Instrument Flight Rules.

IFR Pick-up: A pilot procedure whereby a flight operating to the IFR in Class G airspace changes to VFR upon entering Class E airspace whilst awaiting an airways clearance.

Independent Parallel Approaches: Simultaneous instrument approaches to parallel or near-parallel instrument runways where ATS surveillance system separation minima between aircraft on adjacent extended runway centrelines are not prescribed.

Independent Parallel Departures: Simultaneous departures in the same direction from parallel or near-parallel instrument runways.

Independent Visual Approach: Visual approach operations to parallel or near-parallel instrument runways where the distance between runway centrelines and use of particular procedures allows a visual approach to one runway independently of approaches occurring on an adjacent parallel or near-parallel runway.

Inertial Navigation / Reference System (INS/IRS): A self-contained navigation system that continually measures the accelerations acting upon the vehicle of which it is part. Suitably integrated, these forces provide velocity and thence position information.

Initial Approach Altitude: The altitude/level, measured by reference to QNH and standard pressure respectively, below which an aircraft proceeding towards an aerodrome for the purpose of making an instrument approach is not to descend until the instrument procedure has been initiated.

Initial Approach Fix (IAF): The fix at the commencement of an instrument approach.

Initial Approach Segment: That segment of an instrument approach procedure between the initial approach fix and the intermediate approach fix or, where applicable, the final approach fix or point.

Initial Departure Fix (IDF): The terminal fix for the visual segment and the fix where the instrument phase of the PinS departure begins

Instrument Approach Operations: An approach and landing using instruments for navigation guidance based on an instrument approach procedure. There are two methods for executing instrument approach operations:

- a. two-dimensional (2D) instrument approach operation, using lateral navigation guidance only; and
- b. three-dimensional (3D) instrument approach operation, using both lateral and vertical navigation guidance.

Note 1: Lateral and vertical navigation guidance refers to the guidance provided either by:

- a. ground-based radio navigation aids; or
- b. computer-generated navigation data from ground-based, space-based, self-contained navigation aids or a combination of these.

Note 2: The classification of instrument approach operations is outlined in AIC H26/14.

Instrument Approach Procedure (IAP): A series of predetermined manoeuvres by reference to flight instruments with specified protection from obstacles from the initial approach fix, or where applicable, from the beginning of a defined arrival route to a point from which a landing can be completed and thereafter, if a landing is not completed, to a position at which holding or en-route obstacle clearance criteria apply. Instrument approach procedures are classified as follows:

- a. **Non-precision approach (NPA) procedure.** An instrument approach procedure designed for 2D instrument approach operations Type A.

Note: Non-precision approach procedures may be flown using a continuous descent final approach technique (CDFA). CDFA with advisory VNAV guidance calculated by on-board equipment are considered 3D instrument approach operations. CDFA with manual calculation of the required rate of descent are considered 2D instrument approach operations.

- b. **Approach procedure with vertical guidance (APV).** A performance-based navigation (PBN) instrument approach procedure designed for 3D instrument approach operations Type A.
- c. **Precision approach (PA) procedure.** Precision Approach (PA) procedure. An instrument approach procedure based on navigation systems (ILS, MLS, GLS and SBAS CAT I) designed for 3D instrument approach operations Type A or B.

Note: Refer to AIC H26/14 for instrument approach operation types.

Instrument Flight Rules: Those rules specified in Part XI, Division 4 of the CAR.

Instrument Landing System (ILS): A precision instrument approach system which normally consists of the following electronic components: VHF Localiser, UHF Glideslope, VHF Marker Beacons.

Instrument Meteorological Conditions: Meteorological conditions expressed in terms of visibility, ceiling and distance from cloud, less than the minima specified for visual meteorological conditions.

Instrument Runway: One of the following types of runways intended for the operation of aircraft using instrument approach procedures:

- a. **Non-precision approach runway:** An instrument runway served by visual aids and a non-visual aid providing at least directional guidance adequate for a straight-in approach.

- b. Precision approach runway, CAT I: An instrument runway served by a precision approach procedure and visual aids intended for operations with a decision height not lower than 60M (200FT) and either a visibility not less than 800M, or a RVR not less than 550M.
- c. Precision approach runway, CAT II: An instrument runway served by ILS and visual aids intended for operations with a decision height lower than 60M (200FT), but not lower than 100FT, and a runway visual range not less than 300M.
- d. Precision approach runway, CAT III: An instrument runway served by ILS to and along the surface of the runway and:
 - 1) for CAT 111A - intended for operations with a decision height lower than 30M (100FT), or no decision height, and a runway visual range not less than 175M;
 - 2) for CAT 111B - intended for operations with a decision height lower than 15M (50FT), or no decision height, and a runway visual range less than 175M, but not less than 50M;
 - 3) for CAT 111C - intended for operations with no decision height and no runway visual range limitations.

Integrated Aeronautical Information Package: A package which consists of the following elements:

- a. AIP, including amendment service;
- b. supplements to the AIP;
- c. NOTAM and Preflight Information Bulletins (PIBs);
- d. AIC; and
- e. checklists and summaries.

Integrity: That quality which relates to the trust which can be placed in the correctness of information supplied by a system. It includes the ability of a system to provide timely warnings to users when the system should not be used for navigation.

Intermediate Approach Segment: That segment of an instrument approach procedure between either the intermediate approach fix and the final approach fix or point, or between the end of the reversal, racetrack or dead reckoning track procedure and the final approach fix or point, as appropriate.

Intermediate Fix (IF): A fix that marks the end of an initial segment and the beginning of the intermediate segment.

In the Vicinity: An aircraft is in the vicinity of a non-controlled aerodrome if it is within a horizontal distance of 10 miles; and within a height above the aerodrome reference point that could result in conflict with operations at the aerodrome.

Joint User Aerodrome: An aerodrome used jointly on a continuing or regular basis by civil and service aircraft where a tenant department requires special facilities on the aerodrome for the conduct of its operations.

Land and Hold Short Operations (LAHSO): A procedure involving dependent operations conducted on two intersecting runways whereby aircraft land and depart on one runway while aircraft landing on the other runway hold short of the intersection.

Landing Area: That part of the movement area intended for the landing or takeoff of aircraft.

Landing Distance Available: The length of runway which is declared by the State to be available and suitable for the ground landing run of an aeroplane. The landing distance available commences at the threshold and in most cases corresponds to the physical length of the runway pavement. However, the threshold may be displaced from the end of the pavement when it is considered necessary to make a corresponding displacement of the approach area and surface by reason of obstructions in the approach path of the runway.

Land Rescue Unit: A land party equipped to undertake a search for an aircraft within the region of its responsibility.

Level: A generic term relating to the vertical position of an aircraft in flight and meaning variously, height, altitude or flight level.

Localiser (LOC): The component of an ILS which provides azimuth guidance to a runway. It may be used as part of an ILS or independently.

Logon address: A specified code used for data link logon to an ATS unit.

Low Jet Route (LJR): A route, or part of a route, at or below 5,000FT AGL used by MLJ aircraft for low level, high speed operations.

Low Visibility Operation: An operation involving:

- a. an approach with minima less than precision approach category I; or
- b. a takeoff with visibility below 550M.

Low Visibility Procedures: Procedures applied at an aerodrome for protecting aircraft operations during conditions of reduced visibility or low cloud.

Lowest Safe Altitude (LSALT): The lowest altitude which will provide safe terrain clearance at a given place.

Lowest Safe Altitude Effective Area: The LSALT Effective area is the area within the envelope described by a 5NM buffer around the navigation tolerance area for a route or route segment.

Lowest Usable Level: The lowest level available to an aircraft operating above an active Restricted Area or Restricted Airspace to provide safe vertical separation from the activity in that area.

Mach-Number Technique: The technique of clearing successive turbo-jet aircraft, operating along the same track, to maintain specified Mach numbers in order to maintain adequate longitudinal separation between successive aircraft at, or climbing or descending to, the same level.

Manoeuvring Area: That part of an aerodrome to be used for the takeoff, landing and taxiing of aircraft, excluding aprons.

Marker: An object displayed above ground level in order to indicate an obstacle or delineate a boundary.

Marker Beacon: A type of radio beacon, the emissions of which radiate in a vertical pattern.

Markings: A symbol or group of symbols displayed on the surface of the movement area in order to convey aeronautical information.

Maximum Elevation Figures: Shown on chart series JOG-A, TPC and ONC's in quadrangles bounded by lines of latitude and longitude, represented in thousands and hundreds of feet above mean sea level. MEFs are based on information available concerning the highest known feature in each quadrangle, including terrain and obstructions.

Maximum Takeoff Weight (MTOW): The maximum takeoff weight of an aircraft as specified in its Certificate of Airworthiness.

Medical Flight: A flight providing transport of medical patients, personnel, and/or equipment, prioritised as follows:

- a. MEDEVAC: A life critical medical emergency evacuation e.g. An aircraft proceeding to pick up, or carrying a severely ill patient, or one for whom life support measures are being provided.
- b. HOSP: A medical flight declared by medical authorities e.g. An aircraft transporting or proceeding to pick up medical personnel and/or equipment urgently required for the treatment of a severely patient, or returning urgently required medical personnel and/or equipment at the termination of a MEDEVAC flight.

METBRIEF (Automated Meteorological Telephone Briefing): METBRIEF is a self help system which delivers meteorological information on the telephone, using a computer generated voice, in response to a tone generated telephone request.

Meteorological Information: Meteorological report, analysis, forecast and any other statement relating to existing or expected meteorological conditions.

Meteorological Office (MO): An office designated to provide meteorological service for air navigation.

Meteorological Warning: A statement or meteorological report of the occurrence or expectation of a deterioration or improvement in meteorological conditions or of any meteorological phenomenon which may seriously affect the safe operation of aircraft.

Military Airspace: A collective term encompassing military controlled airspace/control zones, military Restricted Areas and Military Operating Areas (MOA).

Military Low Jet (MLJ): Military aircraft operating on LJR.

Military Low Jet Route: See Low Jet Route (LJR).

Military Operating Area (MOA): An airspace of defined dimensions, with specified conditions, established for hazardous military activities.

Minimum Crossing Altitude (MCA): The minimum IFR altitude that aircraft may cross the IDF.

Minimum Descent Altitude/Height (MDA/H): A specified altitude or height in a 2D instrument approach operation or circling approach operation below which descent must not be made without the required visual reference.

Note 1: MDA is referenced to Mean Sea Level (MSL) and MDH is referenced to the aerodrome elevation or to the threshold elevation if that is more than 7FT below the aerodrome elevation. A minimum descent height for a circling approach is referenced to the aerodrome elevation.

Note 2: The required visual reference means that section of the visual aids or of the approach area which should have been in view for sufficient time for the pilot to have made an assessment of the aircraft position and rate of change of position, in relation to the desired flight path. In the case of a circling approach the required visual reference is the runway environment.

Minimum Fuel: The term used to describe a situation when an aircraft's fuel supply has reached a state where having committed to land at a specific aerodrome, the pilot calculates that any change to the existing clearance to that aerodrome may result in landing with less than final fuel reserve for the flight.

Note: The minimum fuel state is not an emergency situation but an indication that an emergency is possible should any additional delay occur.

Minimum Sector Altitude (MSA): The lowest altitude which may be used which will provide a minimum clearance of 1,000FT above all objects located in an area contained within a circle or a sector of a circle of 25NM or 10NM radius centred on a significant point, the ARP or the HRP.

Minimum Vector Altitude: The lowest altitude which a controller may assign to a pilot in accordance with the RADAR Terrain Clearance chart.

Missed Approach Holding Fix (MAHF): A fix used in RNAV applications that marks the end of the missed approach segment and the centre point for the missed approach holding.

Missed Approach Point (MAPt): That point in an instrument approach procedure at or before which the prescribed missed approach procedure must be initiated in order to ensure that the minimum obstacle clearance is not infringed.

Missed Approach Procedure: The procedure to be followed if the approach cannot be continued.

Missed Approach Turning Fix (MATF): A fix different from MAPt that marks a turn in the missed approach segment.

Movement Area: That part of an aerodrome to be used for the takeoff, landing and taxiing of aircraft, consisting of the manoeuvring area and the apron(s).

NAIPS: The National Aeronautical Information Processing System, which provides briefings and flight notification functions.

Navigation Specification: A set of aircraft and flight crew requirements needed to support performance based navigation operations within a defined airspace. There are two kinds of navigation specifications:

- a. **RNP Specification:** A navigation specification based on area navigation that includes the requirement for on board performance monitoring and alerting, designated by the prefix RNP, e.g. RNP 4, RNP APCH.
- b. **RNAV Specification:** A navigation specification based on area navigation that does not include the requirement for on board performance monitoring and alerting, designated by the prefix RNAV, e.g. RNAV 5, RNAV 1.

Note: The Performance-based Navigation Manual (Doc 9613), Volume II, contains detailed guidance on navigation specifications.

Night: The period between the end of evening civil twilight (last light) and the beginning of the following morning civil twilight (first light).

Night Vision Device (NVD): Night vision enhancement equipment fitted to, or mounted in or on, an aircraft, or worn by a person in the aircraft, and that can detect and amplify light in both the visual and near infra-red bands of the electromagnetic spectrum or provide an artificial image representing topographical displays.

Night Vision Goggles (NVG): A self-contained binocular night vision enhancement device, usually helmet mounted or otherwise worn by a person, that can detect and amplify light in both the visual and near infra-red bands of the electromagnetic spectrum.

Night Vision Imaging System (NVIS): A self-contained binocular night vision enhancement device, usually including goggles, that:

- a. is helmet mounted or otherwise worn by a person; and
- b. can detect and amplify light in both the visual and near infra-red bands of the electromagnetic spectrum

Non-Controlled Aerodrome: An aerodrome at which air traffic control is not operating.

Non-Directional Beacon (NDB): A special radio station, the emissions of which are intended to enable a mobile station to determine its radio bearing or direction with reference to that special radio station.

Normal Operating Zone (NOZ): Airspace of defined dimensions extending to either side of a published instrument approach procedure final approach course or track. Only that half of the normal operating zone adjacent to a No-Transgression Zone (NTZ) is taken into account in independent parallel approaches.

NOTAM: A notice distributed by means of telecommunication containing information concerning the establishment, condition or change in any aeronautical facility, service, procedure or hazard, the timely knowledge of which is essential to personnel concerned with flight operations.

Note: A Note contains information of an explanatory nature and supports the relevant parent text.

No-Transgression Zone (NTZ): In the context of independent parallel approaches, a corridor of airspace of defined dimensions located centrally between the two extended runway centrelines, where a penetration by an aircraft requires a controller intervention to manoeuvre any threatened aircraft on the adjacent approach.

Obstruction Lights: Lights mounted on or adjacent to obstructions or potential hazards to aircraft moving on the ground or in the navigable airspace, for the purpose of indicating by night, the obstructions or hazards.

Obstruction Markers: Markers on or adjacent to obstructions or potential hazards to aircraft moving on the ground or in the navigable airspace, for the purpose of indicating, by day, the obstructions or hazards.

One Way Route: A route with limitations for use in one direction, depicted on ERC-H, ERC-L and/or TAC charts by an arrow in the direction that can be used without limitation (see ERSA GEN-FPR for additional details).

Operator: A person, organisation or enterprise engaged in, or offering to engage in, aircraft operation.

Operator's Local Representative (for the provision of meteorological services): A person, at or near an aerodrome or ATC centre, designated by the operator to supply operational information to the local meteorological office and to receive meteorological information for operational purposes.

Overshoot: That manoeuvre requested by an aircraft captain or approved by an air traffic controller, whereby the aircraft captain continues their landing approach to a nominated minima and then discontinues by climbing back towards the circuit altitude on the upwind leg of the circuit or proceeds as directed by ATC. An overshoot shall be initiated no less than 200FT above the landing runway threshold. When reduced landing separation is authorised, and achieved, an overshoot may be initiated not less than 50FT above the landing runway threshold.

Overshoot Shear: A wind shear occurrence which produces an INITIAL effect of overshooting the desired approach path and/or increasing airspeed.

Parking Area: A specially prepared or selected part of an aerodrome within which aircraft may be parked.

Passive LAHSO Runway: The runway used during LAHSO for arriving and departing aircraft that have the full length available.

Pavement Classification Number (PCN): A number expressing the bearing strength of a pavement for unrestricted operations.

Performance-Based Navigation (PBN): Area navigation based on performance requirements for aircraft operating along an ATS route, on an instrument approach procedure or in a designated airspace.

Note: Performance requirements are expressed in navigation specifications (RNAV specification, RNP specification) in terms of accuracy, integrity, continuity, availability and functionality needed for the proposed operation in the context of a particular airspace concept.

Performance Class 1 (PC1): PC1 is the class of helicopter performance such that in the event of failure of the critical power-unit the helicopter is able either to land within the rejected takeoff distance available, or to safely continue the flight to an appropriate landing area, depending on when the failure occurs.

Performance Class 2 (PC2): PC2 is the class of helicopter performance such that in the event of critical power-unit failure performance is available to enable the helicopter to safely continue the flight except when the failure occurs early during the takeoff manoeuvre or late in the landing manoeuvre, in which cases a forced landing may be required.

Permissible All-Up-Weight: The weight to which an aircraft is limited by virtue of the physical characteristics of an aerodrome.

Point-in-Space Reference Point: Reference point for the point-in-space approach as identified by the latitude and longitude of the MAPT.

Precision Approach Procedure: An instrument approach procedure utilising lateral and vertical guidance provided by an ILS or GLS.

Precision or Electronic Approach Aid: Any air or ground interpreted navigation facility which accurately fixes the position of an aircraft in azimuth, elevation, and in some cases range with respect to the ground point of intercept.

Precision Runway Monitor (PRM): An ATS surveillance system and associated procedures used for independent parallel approaches to closely spaced runways.

Pre-Departure Clearance (PDC): A means of delivering an unsolicited, text-based airways clearance to eligible aircraft via an ATC data link.

Preferred Runway: A runway nominated by ATC or listed in the AIP as the most suitable for the prevailing wind, surface conditions or noise sensitive areas in the proximity of the aerodrome.

Primary Means Navigation System: A navigation system that, for a given operation or phase of flight, must meet accuracy and integrity requirements, but needs to meet full availability and continuity of service requirements. Safety is achieved by either limiting flights to specific time periods, or through appropriate procedural restrictions and operational requirements.

Private IFR: The Private IFR Rating (PIFR) authorises the holder to act as aircraft captain of flights under the IFR by day in single pilot aircraft having a MTOW not greater than 5,700KG.

Primary RADAR: A RADAR system which uses reflected radio signals.

Procedural Service: Term used to indicate that information derived from an ATS surveillance system is not required for the provision of ATS.

Procedure Altitude/Height: A specified altitude/height flown at or above the minimum altitude/height, and established to accommodate a stabilised descent at a prescribed descent gradient/angle in the intermediate/final approach segment.

Profile: The orthogonal projection of a flight path or portion thereof on the vertical surface containing the nominal track.

Prohibited Area: An airspace of defined dimensions, above the land areas or territorial waters of a State, within which the flight of aircraft is prohibited. Designation is appropriate only for reasons of military necessity.

Published Speed: A speed restriction shown on a Standard Instrument Departure (SID), Standard Instrument Arrival (STAR), or other instrument flight procedure.

QNH Altimeter Setting: That pressure setting which, when placed on the pressure setting sub-scale of a sensitive altimeter of an aircraft located at the reference point of an aerodrome, will cause the altimeter to indicate the vertical displacement of the reference point above mean sea level.

RADAR: A radio detection device which provides information on range, azimuth and/or elevation of objects.

Radio Altimeter (RA) Height: An indication of the vertical distance between a point on the nominal glidepath at DA and the terrain directly beneath this point.

Radio Navigation Service: A service providing guidance information or position data for the efficient and safe operation of aircraft supported by one or more radio navigation aids.

Rapid-Exit Taxiway: A taxiway connected to a runway at an acute angle and designed to allow landing aeroplanes to turn off at high relative speeds.

Receiver Autonomous Integrity Monitoring (RAIM): A system whereby an airborne GNSS receiver/processor autonomously monitors the integrity of the navigation signals from GNSS satellites.

Reciprocal Tracks: Tracks where the angle between one track and the reciprocal of another track is less than 45°.

Reduced Vertical Separation Minimum (RVSM): The vertical separation minimum of 1000FT between FL290 and FL410 inclusive.

Reference Datum Height (RDH): The height of the measured ILS glide path at the threshold. It will provide a similar value to Threshold Crossing Height.

Reporting Point: A specified geographical location in relation to which the position of an aircraft can be reported.

Required Navigation Performance (RNP): A statement of the navigation performance necessary for operation within a defined airspace.

Rescue Coordination Centre (RCC): A unit established for promoting efficient organisation of search and rescue service and for coordinating the conduct of search and rescue operations within a search and rescue region.

Resolution Advisory (RA): An indication given to the flight crew recommending a manoeuvre or a manoeuvre restriction to avoid collision.

Restricted Airspace: An airspace designated for air traffic service purposes through which the flight of aircraft is restricted in accordance with certain specified conditions.

Note: This term is normally used whenever the activities of the Administering Authority of the airspace are a hazard to others, or others constitute a hazard to the Administering Authority.

Restricted Area: An airspace of defined dimensions above the land areas or territorial waters of a State, within which the flight of aircraft is restricted in accordance with certain specified conditions.

Note: This designation is used when necessary in the interests of public safety or the protection of the environment.

RNP Type: A containment value expressed as a distance in nautical miles from the intended position within which flights would be for at least 95 per cent of the total flying time.

Rotating Beacon: A light beacon having a flashing beam characteristic brought about by mechanical rotation of the optical system about a vertical axis.

Route: A way to be taken in flying from a departure to a destination aerodrome, specified in terms of track and distance for each route segment.

Runway (RWY): A defined rectangular area on a land aerodrome prepared for the landing and takeoff of aircraft.

Runway-Holding Position: A designated position intended to protect a runway, an obstacle limitation surface, or an ILS critical/sensitive area at which taxiing aircraft and vehicles must stop and hold, unless otherwise authorised by the aerodrome control tower.

Note: In radiotelephony phraseologies, the expression "holding point" is used to designate the runway-holding position.

Runway Number: The runway identification associated with the runway direction end.

Runway Strip: The defined area, including the runway (and stopway if provided), intended both to reduce the risk of damage to aircraft inadvertently running off the runway and to protect aircraft flying over it during takeoff, landing or missed approach.

Runway Surface Condition(s): A description of the condition(s) of the runway surface, from the following:

- a. Dry Runway – See 'Dry Runway' definition.
- b. Wet Runway – See 'Wet Runway' definition.
- c. Slippery wet runway – A wet runway where the surface friction characteristics of a significant portion of the runway have been determined to be degraded.

Note: Slippery wet runway surface condition is reported as a SLIPPERY WET runway with RWYCC 3.

- d. Contaminated Runway – See the definitions for 'Contaminated Runway' and 'Runway Surface Condition Descriptors'.

Runway Surface Condition Descriptors: One of the following elements on the surface of the runway:

- a. **Compacted Snow:** Snow that has been compacted into a solid mass such that aeroplane tires, at operating pressures and loadings, will run on the surface without significant further compaction or rutting of the surface.
- b. **Dry Snow:** Snow from which a snowball cannot readily be made.
- c. **Frost:** Frost consists of ice crystals formed from airborne moisture on a surface whose temperature is below freezing. Frost differs from ice in that the frost crystals grow independently and therefore have a more granular texture.

Note: Under certain conditions frost can cause the surface to become very slippery and it is then reported appropriately as reduced braking action.

- d. **Ice:** Water that has frozen or compacted snow that has transitioned into ice, in cold and dry conditions.
- e. **Slush:** Snow that is so water-saturated that water will drain from it when a handful is picked up or will splatter if stepped on forcefully.
- f. **Standing Water:** Water of depth greater than 3mm.

Note: This is the most likely runway contaminant to be experienced in Australia. Running water of depth greater than 3mm is reported as standing water.

- g. **Wet Ice:** Ice with water on top of it or ice that is melting.
- h. **Wet Snow:** Snow that contains enough water content to be able to make a well-compacted, solid snowball, but water will not squeeze out.

Runway Visibility (RV): The distance along a runway over which a person can see and recognise a visibility marker or runway lights.

Note: The term RUNWAY VISIBILITY is used by ATC or ground personnel to report visibility along a runway as determined by a ground observer.

Runway Visual Range (RVR): The range over which the pilot of an aircraft on the centre-line of a runway can see the runway surface markings or the lights delineating the runway or identifying its centre-line. (ICAO)

Note: Within Australia, the term "RUNWAY VISUAL RANGE" or "RVR" is used exclusively in relation to RVR measured by an instrumented system.

Same Tracks: Tracks that converge or diverge by less than 45°.

SARTIME: The time nominated by a pilot for the initiation of SAR action if a report has not been received by the nominated unit.

SARWATCH: A generic term covering SAR alerting based either on full position reporting procedures, scheduled reporting times (SKEDS) or SARTIME.

Search and Rescue (SAR): The act of finding and returning to safety, aircraft and persons involved in an emergency phase.

Search and Rescue Region (SRR): The specified area within which search and rescue is coordinated by a particular Rescue Coordination Centre.

Secondary Surveillance RADAR: A system of secondary RADAR using ground transmitters/receivers (interrogators) and airborne transponders.

Segment Minimum Safe Altitude: The lowest altitude at which the minimum obstacle clearance is provided.

Segregated Parallel Operations: Simultaneous operations on parallel or near-parallel instrument runways in which one runway is used exclusively for approaches and the other runway is used exclusively for departures.

Self Contained Navigation Systems: Area navigation systems based on INS, IRS or GNSS.

Sensitive Area: A sensitive area is a block of airspace of defined dimensions within which the flight of aircraft should be avoided unless operational or flight safety considerations make such a flight necessary. Sensitive areas are shown on the relevant Airservices Australia ERCA and are designated in the same format as P, R and D areas (e.g.: YB/S2 is Australia, Brisbane FIR, Sensitive Area Number 2).

Significant Point: A specified geographical location used in defining an ATS route or the flight path of an aircraft and for other navigation and ATS purposes.

Note: There are three categories of significant points: ground-based navigation aid, intersection and waypoint. In the context of this definition, intersection is a significant point expressed as radials, bearings and/or distances from ground-based navigation aids.

Significant Weather: Any weather phenomenon which might affect flight visibility or present a hazard to an aircraft.

Simultaneous Opposite Direction Parallel Runway Operations (SODPROPS): A condition whereby arriving aircraft will approach and land on one runway, concurrent with aircraft departures from the parallel runway using the opposite direction to that being used for approach and landing.

Situation Display: An electronic display depicting the position and movement of aircraft and other information as required.

SNOWTAM R: A special series NOTAM given in a standard format providing a surface condition report notifying the presence or cessation of hazardous conditions due to snow, ice, slush, frost, standing water or water associated with snow, slush, ice or frost on the movement area.

Sole Means Navigation System: A navigation system that, for a given phase of flight, must allow the aircraft to meet all four navigation system performance requirements - accuracy, integrity, availability and continuity of service.

Space Weather Centre (SWXC): A centre designated to monitor and provide advisory information on space weather phenomena expected to affect high-frequency radio communications, communications via satellite, GNSS-based navigation and surveillance systems and/or pose a radiation risk to aircraft occupants.

Note: A space weather centre is designated as global and/or regional.

Special Air-Report (AIREP Special): An AIREP containing the report of special meteorological conditions, i.e. SIGMET phenomenon, or any other MET phenomenon which is likely to affect the safety or efficiency of other aircraft.

Special Authorisation Category I (SA CAT I) Operation: A precision approach CAT I operation with a DH lower than 200FT, but not lower than 150FT; and an RVR not less than 450M.

Special Authorisation Category II (SA CAT II) Operation: A precision approach operation to a runway where some or all of the elements of the precision approach CAT II lighting system are not available, and with:

- a. a DH lower than 200FT but not lower than 100FT; and
- b. RVR of not less than 350M.

Special Use Airspace (SUA): A generic term used for airspace volumes designated for specific operations that may impose limitations on airspace access or use for non-participating aircraft. SUA includes Prohibited, Restricted, Danger and Military Operating Areas, and airspace reservations.

SSR Code: The number assigned to a particular multiple-pulse reply signal transmitted by a transponder in Mode A or Mode C.

Standard Instrument Arrival (STAR): A designated IFR arrival route linking a significant point, normally on an ATS route, with a point from which a published instrument approach procedure can be commenced.

Standard Instrument Departure (SID): A designated IFR departure route linking the aerodrome or a specified runway of the aerodrome with a specified significant point, normally on a designated ATS route, at which the en route phase of flight commences.

Standard Message Element: Part of a message defined in the PANS-ATM (DOC 4444) in terms of display format, intended use and attributes.

Standard Pressure: The pressure of 1013.2 Hectopascals which, if set upon the pressure sub-scale of a sensitive altimeter, will cause the latter to read zero when at mean sea level in a standard atmosphere.

State Aircraft: An aircraft of any part of the Defence Force (including any aircraft that is commanded by a member of that force in the course of their duties as such a member) and aircraft used in the military, customs, or police services of a foreign country.

Stop-and-Go Landing: A procedure whereby an aircraft lands, comes to a complete stop on the runway and then commences takeoff from that point.

Stopway: A defined rectangular area on the ground at the end of the takeoff run available prepared as a suitable area in which an aircraft can be stopped in the case of an abandoned takeoff.

Supplemental Means Navigation System: A navigation system that must be used in conjunction with a sole means navigation system.

Surveillance Information Service (SIS): An on-request service provided to assist pilots of VFR flights, within ATS surveillance system coverage in Class E and Class G airspace, to avoid other aircraft or to assist in navigation.

Tactical Air Navigation (TACAN): An ultra-high frequency navigation aid which provides a continuous indication of bearing and slant range, in nautical miles, to the selected ground station.

TAF3: An aerodrome forecast (TAF) routinely issued every 3 hours.

Tactical GPS Non-Precision Approach (NPA): A GPS-guided NPA designed to provide an inadvertent IMC recovery capability.

Takeoff Distance Available: The length of the takeoff run available plus the length of clearway available.

Takeoff Run Available: The length of runway which is declared by the State to be available and suitable for the ground run of an aeroplane taking-off. This in most cases corresponds to the physical length of the runway pavement.

Taxiing: Movement of an aircraft on the surface of an aerodrome under its own power, excluding takeoff and landing.

Taxiway (TWY): A defined path on a land aerodrome established for the taxiing of aircraft and intended to provide a link between one part of the aerodrome and another.

Terrain Clearance: The vertical displacement of an aircraft's flight path from the terrain.

Terrain Flight: Terrain flight is flight below 200FT AHO for day and NVD flights. Terrain flight includes any or all of the following techniques aimed at using terrain or vegetation to cover the movement of the aircraft for tactical purposes:

- a. Low Level Flight. Low level flight is conducted at a generally constant altitude and airspeed.
- b. Contour Flight. Contour flight conforms generally to the contours of the earth. It is characterized by generally constant airspeed and varying altitude to achieve generally constant obstacle clearance.
- c. NOE (Nap of the Earth) Flight. NOE flight is conducted at varying airspeeds and altitudes close to terrain or obstacles.

Threshold: The beginning of that portion of the runway usable for landing.

Threshold Crossing Height (TCH): The calculated height of the procedure nominal approach path at the threshold. For ILS or GLS, the TCH will be similar to the Reference Datum Height.

Threshold Lights: Lights placed across the ends of a runway or landing strip to indicate the usable limits thereof.

Total Estimated Elapsed Time: For IFR flights, the estimated time required from takeoff to arrive over that designated point, defined by reference to navigation aids, from which it is intended that an instrument approach procedure will be commenced, or if no navigation aid is associated with the destination aerodrome, to arrive over the destination aerodrome. For VFR flights the estimated time required from takeoff to arrive over the destination aerodrome.

Touch-and-Go-Landing: A procedure whereby an aircraft lands and takes off without coming to a stop.

Touchdown Zone: The first 3,000FT of runway beginning at the threshold.

Touchdown Zone Elevation: The highest runway centreline elevation in the touchdown zone.

Track: The projection on the earth's surface of the path of an aircraft, the direction of which path at any point is usually expressed in degrees from North (true, magnetic or grid).

Traffic Advisory (TA): An Indication given to the flight crew that a certain intruder is a potential threat.

Traffic Alert and Collision Avoidance System: An airborne collision avoidance system based on RADAR beacon signals which operate independent of ground based equipment. TCAS-I generates traffic advisories only. TCAS-II generates traffic advisories, and resolution (collision avoidance) advisories in the vertical plane.

Traffic Avoidance Advice: Advice provided by Air Traffic Control specifying manoeuvres to help a pilot avoid a collision.

Traffic Information: Information issued by Air Traffic Control or Flight Service to alert the pilot of an aircraft to other aircraft which may be close to the position or intended route, of their aircraft, so as to help the pilot avoid a collision.

Traffic Information Broadcasts by Aircraft: When no ATS services are available in a given airspace, CASA may authorise the use of TIBA procedures. This information and the airspace to which it applies shall be promulgated by NOTAM.

Traffic Pattern: The path described by the normal flow of aircraft in the vicinity of an aerodrome as necessitated by the terrain, layout, direction of landing and takeoff and proximity to other aerodromes.

Transition Altitude: The altitude at or below which the vertical position of an aircraft is controlled by reference to altitudes.

Transition Layer: The airspace between the transition altitude and the transition level.

Transition Level: The lowest flight level available for use above the transition altitude.

Transitional Surface: An inclined plane associated with the runway strip and the approach surfaces.

Transponder: A receiver/transmitter which will generate a reply signal upon proper interrogation; the interrogation and reply being on different frequencies.

True Airspeed: The speed of an aircraft relative to undisturbed air.

Unaided NGT Flight: Unaided NGT flight is flight under the VFR at night without Night Vision Devices (NVD).

Unalerted See-and-Avoid: A procedure where flight crew, who have no specific knowledge of other aircraft in their vicinity, rely solely on their ability to physically sight and avoid colliding with aircraft that may be in their vicinity.

Undershoot Shear: A wind shear occurrence which produces an initial effect of undershooting the desired approach path and/or decreasing air speed.

UNICOM (Universal Communications): UNICOM is a non-ATS communications service provided to enhance the value of information normally available about a non-controlled aerodrome.

Unidentified Aircraft: An aircraft which has been observed or reported to be operating in a given area but whose identity has not been established.

Unmanned Free Balloon: A non-power-driven, unmanned lighter-than-air aircraft in free flight.

Note: Unmanned free balloons are classified as small, light, medium and heavy. For further details regarding these classifications and for approvals to operate Unmanned Free Balloons, refer to CASR subpart 101.E.

Unserviceable Area: A portion of the movement area not available for use by aircraft because of the physical condition of the surface, or because of any obstruction on the area.

Vectoring: Provision of navigational guidance to aircraft in the form of specific headings, based on the use of an ATS surveillance system.

VFR Climb and Descent: ATC authorisation for an IFR flight in VMC, in Classes D and E airspace, to conduct a visual climb or descent.

VFR-on-Top: ATC authorisation for an IFR flight to operate in VMC, in Class E airspace at any appropriate VFR altitude or flight level.

VHF Omni-directional Radio Range (VOR): A VHF radio navigational aid which provides a continuous indication of bearing from the selected VOR ground station.

Visibility: Visibility for aeronautical purposes is the greater of:

- a. the greatest distance at which a black object of suitable dimensions, situated near the ground, can be seen and recognized when observed against a bright background; or
- b. the greatest distance at which lights in the vicinity of 1000 candelas can be seen and identified against an unlit background.

Visibility Marker: A dark object of suitable dimensions for use as a reference in evaluating runway visibility.

Visual (ATC usage): Used by ATC to instruct a pilot to see and avoid obstacles while conducting flight below the MVA or MSA/LSALT.

Visual (Pilot usage): Used by a pilot to indicate acceptance of responsibility to see and avoid obstacles while operating below the MVA or MSA/LSALT.

Visual Approach Slope Indicator System (VASIS): A system of lights so arranged as to provide visual information to pilots on approach of their position in relation to the optimum approach slope for a particular runway.

Visual Descent Point: The point on the final approach course of a non-precision straight-in approach from which normal descent from the MDA to the runway touch-down point may be commenced, provided visual reference is established.

Visual Flight Rules: Those rules specified in Part XI, Division 3 of the Civil Aviation Regulations.

Visual Meteorological Conditions: Meteorological conditions expressed in terms of visibility, ceiling and distance from cloud, equal to or better than specified minima.

VOLMET: Meteorological information for aircraft in flight.

Data link-VOLMET (D-VOLMET): Provision of current aerodrome routine meteorological reports (METAR) and aerodrome special meteorological reports (SPECI), aerodrome forecasts (TAF), SIGMET, special air-reports not covered by a SIGMET and, where available, AIRMET via data link.

VOLMET broadcast: Provision, as appropriate, of current METAR, SPECI, TAF and SIGMET by means of continuous and repetitive voice broadcasts.

V_{s1g}: The one-g stall speed at which the aeroplane can develop a lift force (normal to the flight path) equal to its weight.

Warning: Non-compliance with the detailed policy or procedure may result in significant reduction of safety margins.

Way-point: A specified geographical location used to define an area navigation route or the flight path of an aircraft employing area navigation. Way-points are identified as either:

- a. **Fly-by way-point:** A way-point which requires turn anticipation to allow tangential interception of the next segment of a route or procedure, or
- b. **Flyover way-point:** A way-point at which a turn is initiated in order to join the next segment of a route or procedure.

Wet Runway: A runway that:

- a. is covered by surface water not more than 3mm deep; or
- b. is covered by slush or loose snow equivalent to surface water not more than 3mm deep; or
- c. has sufficient moisture on the surface to cause it to appear reflective, but without significant areas of standing water.

Note: Wet Runway now covers the previous Australian description – ‘Damp’.

World Area Forecast Centre (WAFC): A meteorological centre designated to prepare and issue significant weather forecasts and upperair forecasts in digital form on a global basis direct to States using the aeronautical fixed service internet-based services.

World Area Forecast System (WAFS): A worldwide system by which world area forecast centres provide aeronautical meteorological en route forecasts in uniform standardised formats.

2. GENERAL AND METEOROLOGICAL ABBREVIATIONS

2.1 This list covers abbreviations which may be found throughout the ADF AIP, or which are used in Airservices Australia AIP, NOTAM, AIP Supplements (SUP) and in meteorological messages and documentation.

Abbreviations marked “+” may be used as spoken words in radio telephony.

Abbreviations marked “#” may be spoken using the individual letters rather than the phonetic alphabet.

Abbreviations marked “•” are not included in ICAO Doc 8400 and must not be used in international NOTAM.

#2D	Two-dimensional
#3D	Three-dimensional
A	Amber
A/A	Air to Air
•AA	Airworthiness Authority
•AA	Audio Acknowledgment
•AAIS	Automatic Aerodrome Information Service
AAL	Above Aerodrome Level
•AAP	Australian Air Publication
AAR	Air to Air Refuelling
ABF	Australian Border Force
ABM	Abeam
ABN	Aerodrome Beacon
•ABW	Air Base Wing
ABV	Above
•AC	Advisory Circular
AC	Alto cumulus
+ACARS	Aircraft Communication Addressing and Reporting System (pronounced “AY-CARS”)
+ACAS	Airborne Collision Avoidance System
#ACC	Area Control Centre
•ACD	Airways Clearance Delivery
ACFT	Aircraft
ACK	Acknowledge
ACN	Aircraft Classification Number
ACP	Altimeter Check Point
ACPT	Accept, Accepted
•ACR	Approach Control RADAR
•ACSI	Air Command Standing Instruction
ACT	Active, Activated, Activity
AD	Aerodrome
ADDN	Addition, Additional
#ADF	Automatic Direction Finding Equipment
•#ADF	Australian Defence Force
•ADF AA	ADF Airworthiness Authority
•ADF AIP	ADF Aeronautical Information Package
+ADIZ	Air Defence Identification Zone

ADJ	Adjacent
#ADS-B	Automatic Dependent Surveillance - Broadcast
#ADS-C	Automatic Dependent Surveillance - Contract
ADZ	Advise
•AEP	Aerodrome Emergency Plan
•AFB	Air Force Base
•AFC	Area Forecast Centre
•AFHQ	Air Force Headquarters
AFIL	Flight Notification filed in the air, or indicating the position at which ATS services will first be required.
AFM	Yes, Affirm, Affirmative, that is correct
•AFO	Army Flying Orders
•+AFRU	Aerodrome Frequency Response Unit
AFT	After...
#AFTN	Aeronautical Fixed Telecommunication Network
•AFZ	Australian Fishing Zone(s)
A/G	Air to Ground
AGA	Aerodromes, Air Routes and Ground Aids
•A-GEAR	Arresting Gear
#AGL	Above Ground Level
AGN	Again
•AH	After Hours
•AI	Aeronautical Information
#AIC	Aeronautical Information Circular
•#AIP	ADF Aeronautical Information Package
#AIP	Aeronautical Information Publication (an Airservices Australia publications)
•+AIPAB	Aeronautical Information Package Amendment Bulletin
+AIRAC	Aeronautical Information Regulation and Control
+AIREP	Air Report
+AIRMET	Information concerning weather significant to aircraft operations at or below 10,000FT not contained in a valid GAF
#AIS	Aeronautical Information Service
•AKD	Altitude Keeping Device
•#ALA	Aircraft Landing Area
+ALERFA	Alert phase
ALS	Approach Lighting System
ALT	Altitude
ALTN	Alternate, Alternating (light alternates in colour)
ALTN	Alternate (aerodrome)
•ALTRV	Altitude Reservation
AMD	Amend, Amended
•AMDAR	Aircraft Meteorological Data Relay
AMDT	Amendment (AIP amendment)

•AMSA	Australian Maritime Safety Authority
#AMSL	Above Mean Sea Level
•AOC	Air Operators Certificate
•AOCC	Air Operations Communications Centre
•AOCS	Air Operations Communications System
AP	Airport
+APAPI	Abbreviated Precision Approach Path Indicator (pronounced "AY-PAPI")
APCH	Approach
APN	Apron
APP	Approach Control, Approach Control Office, Approach Control Service
APR	April
APRX	Approximate, Approximately
#APU	Auxiliary Power Unit
APV	Approach Procedure with Vertical Guidance
•AQZ	Area QNH Zone
•ARA	Airborne RADAR Approach
•ARIP	Air Refuelling Initial Point
•ARN	Aviation Reference Number
ARNG	Arrange
ARP	Aerodrome Reference Point
ARR	Arrive, Arrival
AS	Altostratus
•#ASAP	As Soon as Possible
ASC	Ascent to, Ascending to
•ASCC	Air Standardization Coordinating Committee
ASDA	Accelerate-Stop Distance Available
ASE	Altimetry System Error
•A-SMGCS	Advanced Surface Movement Guidance and Control System
ASPH	Asphalt
•ASR	Area Surveillance RADAR
•ASSW	Associated with
#ATA	Actual Time of Arrival
#ATC	Air Traffic Control (in general)
#ATD	Actual Time of Departure
ATFM	Air Traffic Flow Management
•ATFMX	Exemption from AFTM measures by ATC
ATM	Air Traffic Management
ATP	At...(time or place)
+ATIS	Automatic Terminal Information Service
#ATS	Air Traffic Services
•ATSAS	Automatic Thunderstorm Alert Service
ATTN	Attention

+AT-VASIS	Abbreviated "T" Visual Approach Slope Indicator System (pronounced "AY-TEE-VASIS")
ATZ	Aerodrome Traffic Zone
AUG	August
AUTH	Authorised, Authorisation
•AUTO	Fully Automated Report (MET code)
AUW	All Up Weight
AUX	Auxiliary
AVBL	Available
•+AVFAX	Meteorological and NOTAM Facsimile Service
AVG	Average
+AVGAS	Aviation Gasoline
•AVM	Abrupt Vertical Manoeuvres
•+AWIS	Aerodrome Weather Information Service
•AWR	Aerodrome Weather Report
•AWS	Automatic Weather Station
AWY	Airway
AZM	Azimuth
B	Blue
+BARO-VNAV	(to be pronounced "BAA-RO-VEENAV") Barometric Vertical Navigation
BASE	Cloud Base
•BASl	Bureau of Aviation Safety Investigation
BCFG	Fog Patches
BCN	Beacon (aeronautical ground light)
BCST	Broadcast
•BCTA	Base of CTA (used only on charts)
BDRY	Boundary
BECMG	Becoming
BFR	Before
BKN	Broken (cloud descriptor)
BL...	Blowing (followed by DU=dust, SA=sand or SN=snow)
BLDG	Building
BLW	Below
•BOA	Break-Off Altitude
•BOF	Briefing Office
•BOH	Break-Off Height
•BoM	Bureau of Meteorology
BOMB	Bombing
BR	Mist
BRG	Bearing
BRKG	Braking
BS	Broadcasting Station (Commercial)

BTN	Between
C	Degrees Celsius (Centigrade)
C	Centre (Runway)
•CA/GRS	Certified Air/Ground Radio Service
•CAO	Civil Aviation Order
•CAR	Civil Aviation Regulation
•CASA	Civil Aviation Safety Authority
•CASR	Civil Aviation Safety Regulations
+CAT	Category
CAT	Clear Air Turbulence
•CAT	ADF AIP Catalogue
+CAVOK	Visibility, cloud and present weather better than prescribed values or conditions (pronounced "KAV-OH-KAY")
#CB	Cumulonimbus
CC	Cirrocumulus
•CCTS	Circuits
•CDFA	Continuous Descent Final Approach technique
CDR	Conditional Route
•CEN	En route and area ATC unit
•CET	Clearance Expiry Time
CFM	Confirm, I confirm
CH	Channel
CHEM	Chemical
CI	Cirrus
CIV	Civil
CK	Check
CL	Centre Line
•C/L	Centre Line
CLA	Clear type of ice formation
CLBR	Calibration
CLD	Cloud
CLG	Ceiling
•CLIAS	Climbing Indicated Airspeed
CLR	Clear, Cleared to..., Clearance
CLSD	Closed, Close, Closing
CM	Centimetre
CMB	Climb to, Climbing to
•CMC	Civil Military Coordinator
CMPL	Completion, Completed, Complete
•CMSD	Commissioned
CNL	Flight plan cancellation message
CNL	Cancel

CNS	Communications, Navigation and Surveillance
COBT	Calculated Off Blocks Time
COM	Communications
CONC	Concrete
COND	Condition
CONS	Continuous
CONST	Construction, Constructed
CONT	Continue(s), Continued
COOR	Coordinate, Coordinated
COORD	Coordinates
COP	Change-over Point
COR	Correct, Corrected, Correction
•COS	Conical Surface
COT	At the Coast, Coastal
COV	Cover, Covered, Covering
•CP	Critical Point
#CPDLC	Controller Pilot Datalink Communication
CRU	Control and Reporting Unit (RAAF)
CRZ	Cruise
CS	Cirrostratus
CS	Call-sign
CST	Central Standard Time
#CTA	Control Area
•+CTAF	Common Traffic Advisory Frequency
CTC	Contact
CTL	Control
CTN	Caution
CTOT	Calculated Take-off Time
CTR	Control Zone
CU	Cumulus
CUF	Cumuliform
CUST	Customs
CW	Continuous Wave/Carrier Wave
CWY	Cleanway
•D	Day, Daily
•D	Deleted
D	Downward (tendency in RVR during previous 10 minutes)
D...	Danger Area (followed by identification)
DA	Decision Altitude
•DACC	Defence Aid to the Civilian Community
•DAH	Designated Airspace Handbook
•DAP	Departure and Approach Procedures

DAR	Design Authority Representative
•DASA	Defence Aviation Safety Authority
+D-ATIS	Data Link Automatic Terminal Information Service (pronounced "DEE-ATIS")
DCKG	Docking
•DCMSD	Decommissioned
#DCPC	Direct Controller-Pilot Communications
DCT	Direct (in relation to flight plan clearances)
•DDAAFS	Directorate of Defence Aviation & Air Force Safety
DEC	December
•DEFCOMMSTA	Defence Communications Station Australia
DEG	Degrees
DEP	Depart, Departure, Departed, Departing, Departure Message
DER	Departure End of Runway
DES	Descend to, Descending to
DEST	Destination
+DETRESFA	Distress Phase
DEV	Deviation, Deviating
#DF	Direction Finder/Finding
DFDR	Digital Flight Data Recorder
DH	Decision Height
•DI(AF)	Defence Instruction (Air Force)
DIF	Diffuse
•DINS	Defense Internet NOTAM Service
•DISP	Displaced
DIST	Distance
DIV	Diversion, Divert, Diverting
DL	Distant Lightning
DLA	Delay, Delayed
•DLE	Delay En Route
DLY	Daily
#DME	Distance Measuring Equipment
DNG	Danger, Dangerous
•DOC	Documents
•DoD	Department of Defense (USA)
+DOF	Date of Flight
DOM	Domestic
DP	Dew Point Temperature
DPT	Depth
#DR	Dead Reckoning
DR...	Low Drifting (followed by DU=dust, SA=sand or SN=snow)
DRG	During
DS	Dust Storm
•DSB	Amplitude Modulated Double Sideband

•DSH	Destination Safety Height
•DSHEA	Destination Safety Height Effective Area
•DSPT	Descent Point
DTG	Date-Time Group
DTHR	Displaced Runway Threshold
•DTRM	Distance To Run Marker
•DTRMB	Distance To Run Marker Board
DTRT	Deteriorate, Deteriorating
DU	Dust
DUC	Dense Upper Cloud
DUR	Duration
DVOR	Doppler VOR
DZ	Drizzle
E	East, East Longitude
•E	Weekends
EAT	Expected Approach Time
EB	Eastbound
#EET	Estimated Elapsed Time
ELEV	Elevation
#ELT	Emergency Locator Transmitter
EM	Emission
EMBD	Embedded in a Layer (to indicate cumulonimbus embedded in layers of other clouds)
EMERG	Emergency
•ENDCE	Endurance
ENE	East North-East
ENG	Engine
ENR	En Route
ENRC	En Route Chart (followed by name/title)
•ENRT	En Route
EOBT	Estimated off Blocks Time
•EOL	Effective Operation Length
•+EPIRB	Electronic Position Indicating Radio Beacon (marine term)
EQPT	Equipment
•#ERC	En Route Chart
•ERCA	En Route Chart Australia
•+#ERSA	En Route Supplement Australia
ESE	East South-East
EST	Estimate or estimated or estimate (message type designator)
•ESTAB	Establish, established, establishing
#ETA	Estimated Time of Arrival, Estimating Arrival
#ETD	Estimated Time of Departure or Estimating Departure

•ETI	Estimated Time Interval
ETO	Estimated Time Over significant point
•ETOPS	Extended Range Operations by Aeroplanes with Two Turbine Power Units
•ETP	Equi-Time Point
EV	Every
EVS	Enhanced Vision System
EXC	Except
EXER	Exercises, Exercising, to exercise
EXP	Expect, Expected, Expecting
EXTD	Extend, Extending, Extended
F	Fixed (chart symbol)
FAC	Facility, Facilities
FAF	Final Approach Fix
•FANS 1/A	The term used to describe the initial future air navigation system
FAP	Final Approach Point
FAS	Final Approach Segment
FATO	Final Approach and Takeoff Area
•FAWP	Final Approach waypoint
+FAX	Facsimile Transmission
FBL	Light (used to indicate the intensity of WX phenomena, interference or static reports, e.g. FBL RA=light rain)
FC	Funnel Cloud (tornado or water spout)
FCST	Forecast
•FDE	Fault Detection and Exclusion
FDPS	Flight Data Processing System
FEB	February
FEW	Few (cloud descriptor)
•FFR	Flood or Fire Relief, Fire Fighting
FG	Fog
•#FIA	Flight Information Area
•FIFOR	Flight Forecast (in International Met Figures)
•FIHA	Flight Information Handbook Australia
#FIR	Flight Information Region
#FIS	Flight Information Service
•FISB	Flight Information Service Broadcasts
FL	Flight Level
FLD	Field
FLG	Flashing
•FLIP	Flight Information Publication
FLR	Flares
FLT	Flight
FLTCK	Flight Check for Calibration of Nav aids

FLUC	Fluctuating, Fluctuation, Fluctuated
FLW	Follow(s), Following
FLY	Fly, Flying
FM	From
FM...	From (followed by time weather change is forecast to begin)
•FMC WPR	The term used to describe flight management computer waypoint position reporting
#FMS	Flight Management System
FMU	Flow Management Unit
•FN	Fly Neighbourly Area
FNA	Final Approach
•FOD	Foreign Object Damage
•FPA	Flight Procedure
FPL	Filed Flight Plan
FPM	Feet per Minute
FPR	Flight Planned Route
FR	Fuel Remaining
•FR	Friday
FREQ	Frequency
FRI	Friday
FRNG	Firing
FRQ	Frequent
•#FS	Flight Service (in general)
•FSP	Fish Spotting
FST	First
•FSU	Flight Service Unit
FT	Feet
FU	Smoke
•FWOC	Fleet Weather and Oceanography Centre
•FXD	Fixed
FZ	Freezing
FZDZ	Freezing Drizzle
FZFG	Freezing Fog
•FZLVL	Freezing Level (in AIRMET products)
FZRA	Freezing Rain
G	Green
G	Variation from mean wind speed (gusts) (MET - used in METAR/SPECI and TAF code forms)
#GA	General Aviation
+GAF	Graphical Area Forecast
•G/A	Ground to Air
G/A/G	Ground to Air and Air to Ground
#GBAS	Ground Based Augmentation System

•GBR	Great Britain
#GCA	Ground Controlled Approach
•GCI	Ground Control Interception
GEN	General
GEO	Geographic, true
•GEOREF	World Geographic Reference System
GES	Ground Earth Station
•GFY	Glider Flying
GLD	Glider
+GLONASS	Global Orbiting Navigation Satellite System (pronounced "GLO-NAS")
#GLS	GBAS landing system
•GNC	Global Navigation Chart
GND	Ground
GNDCK	Ground Check
#GNSS	Global Navigation Satellite System
GP	Glide Path
•GPIP	Glide Path Intercept Point
#GPS	Global Positioning System
#GPU	Ground Power Unit
#GPWS	Ground Proximity Warning System
•GPWT	Grid Point Wind and Temperature
GR	Hail
•GRAD	Minimum Required Climb Gradient
+GRASS	Grass Landing Area
•GRF	Global Reporting Format
+GRIB	Processed meteorological data in the form of grid point values expressed in binary form (meteorological code)
•GRIV	Grivation
GRVL	Gravel
GS	Groundspeed
GS	Small Hail and/or Snow Pellets
H	High pressure area or the centre of high pressure (MET)
•HH	Time of commencement of a meteorological report validity period
•H+...	Hour plus Minutes past the Hour
#H24	Continuous day and night service
•HAA	Height Above Aerodrome
•HAT	Height Above Threshold
•HAZMAT	Hazardous Material
HBN	Hazard Beacon
•HDF	HF Direction Finder
HDG	Heading
•HDS	Hours of Daylight Saving

•HEAD	Head of State
HEL	Helicopter
#HF	High Frequency (3,000 to 30,000 KHz)
HGT	Height, Height Above
•+HIAL	High Intensity Approach Lighting
•HIOL	High Intensity Obstacle Lights
•HIRL	High Intensity Runway Lighting
#HJ	Sunrise to Sunset
HLDG	Holding
HLP	Heliport
•HLS	Helicopter Landing Site
#HN	Sunset To Sunrise
HO	Service available to meet operational requirements
•HOL	Holiday
•HORIZ	Horizontal
HOSP	Hospital Aircraft
HPA	Hectopascal
•HPOX	High Pressure Oxygen
•HQAC	Headquarters Air Command
HR	Hours
HRP	Heliport Reference Point
•HS	Homestead
HS	Service available during hours of scheduled operations
HSL	Hold Short Lights
HUD	Head-up Display
•HUM	Humanitarian
HVY	Heavy
HVY	Heavy (used to indicate the intensity of WX phenomena, e.g. HVY RA=heavy rain)
HX	No specific working hours
HZ	Haze
HZ	Hertz (cycles per second)
•HZS	Horizontal Surface
•I	Island
IAC	Instrument Approach Chart (followed by name/title)
IAF	Initial Approach Fix
•#IAL	Instrument Approach and Landing
IAP	Instrument Approach Procedure
IAR	Intersection of Air Routes
#IAS	Indicated Air Speed
IBN	Identification Beacon
•+ICAO	International Civil Aviation Organization
ICE	Icing

ID	Identifier, Identify
+IDENT	Identification
•+IDEP	Instrument Departure (FPA)
IF	Intermediate Fix or Intermediate Approach Fix
#IFR	Instrument Flight Rules
#ILS	Instrument Landing System
IM	Inner Marker
#IMC	Instrument Meteorological Conditions
IMG	Immigration
IMPR	Improve, Improving, Improvement
INA	Initial Approach
INBD	Inbound
+INCERFA	Uncertainty Phase
+INFO	Information
+INOP	Inoperative
INP	If Not Possible
#INS	Inertial Navigational System
INSTL	Install, Installed, Installation
INSTR	Instrument
INT	Intersection
•INTCP	Intercept
•+INTER	Intermittent (ie. lasting less than 30 minutes). Fluctuations from forecast prevailing conditions
INTL	International
INTRP	Interrupt, Interruption, Interrupted
INTSF	Intensify, Intensifying
INTST	Intensity
•IP	Initial Point
IR	Ice On Runway
•IR	IFR Military Training Routes
•IRS	Inertial Reference System
+ISA	International Standard Atmosphere
ISOL	Isolated
•IVA	Independent Visual Approach
•IWI	Illuminated Wind Indicator
IWP	Intermediate waypoint
JAN	January
•JATO	Jet Assisted Take-Off
•JF	Saturday, Sunday and Public Holidays
•JNC	Jet Navigation Chart
•JO	Monday to Friday except Public Holidays
•JOG	Joint Operations Graphics

JTST	Jet Stream
JUL	July
JUN	June
KG	Kilograms
KHZ	Kilohertz
KIAS	Knots Indicated Airspeed
KM	Kilometre
KMH	Kilometre per Hour
KPA	Kilopascals
KT	Knots
•KVA	Kilovolt amperes
KW	Kilowatts
L	Left (runway identification)
L	Litre
L	Low pressure area or the centre of low pressure (MET)
•LAHSO	Land and Hold Short
+LAT	Latitude
LCA	Locally, Location, Located, Local
•LCN	Load Classification Number
LDA	Landing Distance Available
LDG	Landing
LDI	Landing Direction Indicator
LEN	Length
LF	Low Frequency (30 to 300 KHz)
LGT	Light, Lighting
LGTD	Lighted
LIH	Light Intensity High
LIL	Light Intensity Low
LIM	Light Intensity Medium
•LIOL	Low Intensity Obstacle Lights
•LIRL	Low Intensity Runway Lights
•LJR	Low Jet Route
•LL	Lower Limits
•LLN	Low Level Navigation (military operations)
•LLO	Low Level Operations (military operations)
LMT	Local Mean Time
+LNAV	Lateral Navigation
LOC	Localiser
•LOE	Lane Of Entry
+LONG	Longitude
•LP	Localiser Performance

LPV	Localiser Performance with Vertical Guidance
•LOX	Liquid Oxygen
•LPD	Last Port of Departure
•LPOX	Low Pressure Oxygen
LRG	Long Range
•LSALT	Lowest Safe Altitude
•LSB	Lower Sideband
•LSQ	Line Squall
LTD	Limited
•LUL	Lowest Usable Level
LV	Light and Variable (relating to wind)
LVE	Leave, Leaving
LVL	Level
•LVO	Low Visibility Operation(s)
#LVP	Low Visibility Procedure(s)
LYR	Layer, Layered
•LZ	Landing Zone
M	Mach number (followed by figures)
M	Metres (preceded by figures)
M...	Military Operating Area (followed by identification)
MAG	Magnetic
•MAG	Mobile Arresting Gear
MAINT	Maintenance
•MAN	Manual
•MAO	Military Air Operator
MAP	Aeronautical Maps and Charts
MAPT	Missed Approach Point
MAR	March
MAR	At Sea
•+MARSA	Military Assumes Responsibility for Separation of Military Aircraft
•+MATS	Manual of Air Traffic Services
•MAUW	Maximum All Up Weight
MAWP	Missed Approach waypoint
+MAX	Maximum
MAY	May
•MBA	Mandatory Broadcast Area
MBST	Microburst
MDA	Minimum Descent Altitude
MDH	Minimum Descent Height
#MEA	Minimum Enroute Altitude
•+MEDEVAC	Medical Emergency Evacuation

•MEF	Maximum Elevation Figures
MEHT	Minimum Eye Height Over Threshold
+MET	Meteorological, Meteorology
+METAR	Aviation routine weather report (in aeronautical meteorological code)
MET REPORT	Aviation routine weather report
MF	Medium Frequency (300 to 3,000 KHz)
MHZ	Megahertz
•MI	Shallow (MET)
MIFG	Shallow Fog
MIL	Military
MIN	Minutes
•MIOL	Medium Intensity Obstacle Lights
•MIRL	Medium Intensity Runway Lights
•MISC	Miscellaneous
MKR	Marker Radio Beacon
•MLJ	Military Low Jet
#MLS	Microwave Landing System
•MLW	Maximum Landing Weight
MM	Middle Marker
MNM	Minimum
MNT	Monitor, Monitoring, Monitored
MNTN	Maintain, Maintained, Maintaining
•MO	Monday
•MO	Meteorological Office
MOA	Military Operating Area
MOC	Minimum Obstacle Clearance (required)
•MoD	Ministry of Defence
MOD	Moderate (used to indicate the intensity of WX phenomena, interference or static reports, e.g. MOD RA=moderate rain)
MON	Monday
+MOPS	Minimum Operational Performance Standards
MOV	Move, Moved, Moving, Movement
•MOWP	Method of Working Plan
•MRA	Minimum Reception Altitude
MS	Minus
#MSA	Minimum Sector Altitude
MSG	Message
MSL	Mean Sea Level
MSSR	Monopulse Secondary Surveillance RADAR
MT	Mountain
•MTE	Maximum Terrain Elevation
•MTOW	Maximum Take-off Weight
•MTP	Maximum Tyre Pressure
MTW	Mountain Waves

•MVA	Minimum Vectoring Altitude
MWO	Meteorological Watch Office
MX	Mixed type of ice formation (white and clear)
N	North, North Latitude
•NAA	National Aviation Authority
•NAIPS	National Aeronautical Information Processing System
•NAP	Noise Abatement Procedures
•NAT	NAVAID Training
NAV	Navigation
NAVAID	Navigation Aid
NB	Northbound
NC	No Change
•NCC	Network Coordination Centre
NCD	Nil Cloud Detected (by ceilometer) [used in automated METAR/SPECI]
#NDB	Non Directional Radio Beacon
NE	Northeast
NEG	Negative, No, permission not granted, that is not correct
NGT	Night
+NIL	None
NM	Nautical Miles
NML	Normal
NN	No name, unnamed
NNE	North North East
NNW	North North West
•NOCOM	Non-Continuous Communication Flights
•NOE	Nap Of the Earth
NOF	International Notam Office
•NOMC	National Operations Management Centre
NONSTD	Non-Standard
+NOSIG	No Significant Change
+NOTAM	Notice to Airmen
NOTAMC	Cancelling NOTAM
NOTAMN	New NOTAM
NOTAMR	Replacing NOTAM
NOV	November
#NOZ	Normal Operating Zone
•NP	Navigational Plotting
NPA	Non-Precision Approach
NR	Number
NS	Nimbostratus
NSC	Nil Significant Cloud
NSW	Nil Significant Weather
•NSW	New South Wales

•NT	Northern Territory
•NTA	No TAF Amendment
NTL	National
#NTZ	No Transgression Zone
•NVG	Night Vision Goggles
•+NVIS	Night Vision Imaging System (pronounced "EN-VIZ")
NW	Northwest
NXT	Next
•OAA	Operational Airworthiness Authority
•OAR	Operational Airworthiness Regulator
OBS	Observe, Observed, Observation
OBSC	Obscure, Obscured, Obscuring
OBST	Obstacle
•OBSTR	Obstruction
OCA	Obstacle Clearance Altitude
#OCA	Oceanic Control Area
OCC	Occulting (light)
OCH	Obstacle Clearance Height
OCNL	Occasional, Occasionally
OCS	Obstacle Clearance Surface
OCT	October
•#OCTA	Outside Control Area
•#OCTR	Outside Control Zone
OFZ	Obstacle Free Zone
OHD	Overhead
•OLS	Obstacle Limitation Surface
OM	Outer Marker
•ONC	Operational Navigation Chart
•OO	Observing Office (meteorology)
OPA	Opaque white type of ice formation
OPMET	Operational Meteorological Message
OPN	Open, Opening, Opened
OPR	Operator, Operate, Operative, Operating, Operational
OPS	Operations
O/R	On Request
•ORP	Operational Readiness Platforms
•OSV	Ocean Station Vessel
•OT	Other Times
OVC	Overcast
•OVRN	Overrun
•OW	Over Water

#P...	Prohibited Area (followed by identification)
PA	Precision Approach
•+PAL	Pilot Activated Lighting
PANS	Procedures for Air Navigation Services
+PAPI	Precision Approach Path Indicator
PAR	Precision Approach RADAR
•PARA	Precision Airborne RADAR Approach
PARL	Parallel
PAX	Passengers
•PBG	Pilot Boarding Ground
PBN	Performance-based navigation
•PCA	Planning Chart Australia
PCD	Proceed, Proceeding
PCL	Pilot Controlled Lighting
PCN	Pavement Classification Number
#PDC	Pre-Departure Clearance
•PDF	Pavement Depth Factor
PER	Performance
PERM	Permanent
•PFR	Preferred Route
•PH	Public Holiday
PIB	Pre-flight Information Bulletin
•PIFR	Private IFR (rating)
•PILS	Practice ILS
•PinS	Point-in-Space
PJE	Parachute Jumping Exercise
PL	Ice Pellets
PLN	Flight Plan
PN	Prior Notice Required
#PNR	Point of No Return
PO	Dust Devils
#POB	Number of Persons on Board
POSS	Possible
•PPO	Prior Permission Only
PPR	Prior Permission Required
PPSN	Present Position
•PRD	Prohibited, Restricted and Danger Areas <i>See also SUA</i>
PRFG	Aerodrome Partially Covered by Fog (MET code)
PRI	Primary
PRKG	Parking
•PRM	Precision Runway Monitoring

+PROB	Probable, Probability
PROC	Procedure
•PRORO	Route Forecast
PROV	Provisional
PRP	Point-in-space Reference Point
PS	Plus
PSG	Passing
•PSI	Pounds per Square Inch
PSN	Position
PSP	Pierced Steel Plank
#PSR	Primary Surveillance RADAR
•PT	Point
•PTBL	Portable
PTN	Procedure Turn
•PTT	Press to Talk
•PVT	Private
PWR	Power
#QNE	Altimeter subscale setting of 1013.2HPA
#QNH	Altimeter subscale setting to obtain elevation or altitude
QUAD	Quadrant
R...	Radial from VOR (followed by three figures)
R	Red
R...	Restricted Area (followed by number)
R	Right (runway identification)
R	Runway (followed by figures in METAR/SPECI)
•RA	Radio Altimeter
RA	Rain
RA	Resolution Advisory
•RA	Restricted Area
•RAAF	Royal Australian Air Force
•RAAFE	RAAF Evaluation (pavements)
•RACON	RADAR Beacon
•RAD	Radius
RAFC	Regional Area Forecast Centre
RAG	Ragged
RAG	Runway Arresting Gear
+RAIM	Receiver Autonomous Integrity Monitoring
•RAN	Royal Australian Navy
•+RAPIC	RADAR Picture (MET)
+RASC	Regional AIS System Centre
•RCAM	Runway Condition Assessment Matrix

#RCC	Rescue Coordination Centre
RCF	Radio Communication Failure
•RCGL	Runway Circling Guidance Lights
RCH	Reach, Reaching
RCL	Runway Centre Line
RCLL	Runway Centre Line Lights
•RCR	Runway Condition Report
RDH	Reference Datum Height
RDL	Radial
RDO	Radio
RE...	Recent (used to qualify weather phenomena, e.g. RERA=recent rain)
REC	Receive, Receiver, Received
•RECC	Recommend, Recommended
REDL	Runway Edge Lights
REF	Reference to..., Refer to...
REG	Registration
RENL	Runway End Lights
REP	Report, Reported, Reporting, Reporting Point
REQ	Request, Requested
ERTE	Re Route
•RES	Reserve Fuel
RESA	Runway End Safety Area
•RESTR	Restrictions
•REV	Review
#RF	Constant Radius Arc to Fix
•RFC	Regional Forecasting Centre (MET)
RFFS	Rescue and Fire Fighting Services
RHC	Right Hand Circuit
RIF	Reclearance in Flight
RL	Report Leaving
RLA	Relay to
•RLA	Restricted Landing Area
RLLS	Runway Lead-in Lighting System
RMK	Remark
+RNAV	Area Navigation (Navigation Specification Prefix)
•RNC	Radio Navigation Chart
RNG	Radio Range/Range
#RNP	Required Navigation Performance (Navigation Specification Prefix)
+ROBEX	Regional OPMET Bulletin Exchanges
ROC	Rate Of Climb
ROD	Rate Of Descent
#RP	Remote Pilot

#RPA	Remotely Piloted Aircraft
•+RPAS	Remotely Piloted Aircraft System (pronounced "AR-PAZ")
RON	Remain Overnight
RPT	Repeat, I Repeat
RQ	Require, Required
RQMNTS	Requirements
RSCD	Runway Surface Condition
•RSMC	Regional Specialised Meteorological Centre
RSP	Responder Beacon
•RSTD	Restricted
•RSWT	Route Sector Wind and Temperature
•R/T	Radio Telephone/Radio Telephony
RTE	Route
RTF	Radio Telephone
RTHL	Runway Threshold Light(s)
•RTIL	Runway Threshold Identification Lights
RTN	Return, Returned, Returning
RTS	Return to Service
RTZL	Runway Touchdown Zone Light(s)
RV	Rescue Vessel
#RVR	Runway Visual Range
RVSM	Reduced Vertical Separation Minimum
•RWS	Runway Strip
RWY	Runway
•RWYCC	Runway Condition Code
S	South, South Latitude
SA	Sand
#•SA	Special Authorisation
•SA	Saturday
•SA	South Australia
•SAFE-BAR	Safeland Barrier
SALS	Simple Approach Lighting System
SAN	Sanitary
+SAR	Search and Rescue
•SARMC	Search and Rescue Mission Coordinator
•SARO	Search and Rescue Officer
SARPS	Standards and Recommended Practices (ICAO)
•SART	Search and Rescue Transponder
•+SARTIME	Time Search Action Required
SAT	Saturday
+SATCOM	Satellite Communication

+SATVOICE	Satellite Voice Communication
SB	Southbound
+SBAS	Satellite-Based Augmentation System
SC	Stratocumulus
SCT	Scattered
SDBY	Standby
SE	South East
SEA	Sea (used in connection with sea-surface temperature and state of the sea)
•SEC	Second, Secondary
SEC	Seconds
SECT	Sector
+SELCAL	Selective Calling System
SEP	September
SER	Service, Servicing, Served
SEV	Severe (used to qualify icing and turbulence report)
SFC	Surface
•SFL	Sequenced Flashing Lights
SG	Snow Grains
SGL	Signal
SH...	Showers (followed by RA=rain, SN=snow, PL=ice pellets, GR=hail, GS=small hail and/or snow pellets or combinations thereof, e.g., SHRASN=showers of rain and snow)
+SID	Standard Instrument Departure
SIF	Selective Identification Feature
SIGWX	Significant Weather
+SIGMET	Information concerning en route weather phenomena which may affect the safety of aircraft operations
SIMUL	Simultaneous, Simultaneously
•+SIS	Surveillance Information Service
SIWL	Single Isolated Wheel Loading
+SKED	Schedule, Scheduled
SLP	Speed Limiting Point
SLW	Slow
#SMC	Surface Movement Control
•SMCA	Surface Movement Control Apron
•#SMCV	Surface Movement Control Vehicles
•SMO	Supplementary Meteorological Office
SMR	Surface Movement RADAR
SN	Snow
+SNOWTAM R	A special series NOTAM given in a standard format providing a surface condition report notifying the presence or cessation of hazardous conditions due to snow, ice, slush, frost, standing water or water associated with snow, slush, ice or frost on the movement area
•SODPROPS	Simultaneous Opposite Direction Parallel Runway Operations

•SOT	Start of TORA (takeoff)
•SP	Single Pilot
•SPA	Sport Aviation
+SPECI	Aviation Special Weather (in aeronautical meteorological code)
•SPFIB	Specific Preflight Information Bulletin
+SPOT	Spot wind
SQ	Squall
SQL	Squall Line
•SR	Slow Speed Low Altitude Training Routes
SR	Sunrise
•SRE	Surveillance RADAR Element
#SRR	Search and Rescue Region
SRY	Secondary
SS	Sandstorm
SS	Sunset
SSB	Single Sideband
SSE	South South East
SSR	Secondary Surveillance RADAR
SST	Supersonic Transport
SSW	South South West
ST	Stratus
+STAR	Standard Instrument Arrival
STD	Standard
STF	Stratiform
STN	Station
STNR	Stationary
•STODA	Supplementary Take-off Distance
STOL	Short Take-off and Landing
STS	Status
STWL	Stopway Lights
•SU	Sunday
•SUA	Special Use Airspace <i>See also PRD</i>
SUBJ	Subject to
SUN	Sunday
SUP	AIP Supplement
SUPPS	Regional Supplementary Procedures
SVCBL	Serviceable
•SVY	Survey Operations
SW	South West
•SWS	Soft Wet Surface
SWY	Stopway
•SYMBAS	Symbolisation All Series

T	Bearing (true)
T	Temperature
TA	Traffic Advisory
TA	Transition Altitude
•TAA	Technical Airworthiness Authority
•TAAATS	The Advanced Australian Air Traffic System
•TAC	TACAN (IAL only)
•+TAC	Terminal Area Chart
+TACAN	UHF Tactical Air Navigation Aid
+TAF	Aerodrome Forecast
•TAMM	Technical Airworthiness Management Manual
•TAP	Terminal Approach Procedure
•TAPIL	Terminal Charts Information and Legends
TAR	Terminal Area Surveillance RADAR
•TAR	Technical Airworthiness Regulator
#TAS	True Airspeed
•TAST	Terminal Area Severe Turbulence
TAX	Taxiing, Taxi
•TBA	To be advised
•TBN	Test Beacon
TC	Tropical Cyclone
•TCA	Terminal Control Area
•TCAD	Traffic Alert and Collision Alerting Device
+TCAS	(tee-kas) Traffic Alert and Collision Avoidance System
TCH	Threshold Crossing Height
•TCTA	Trans-Continental Control Area
•TCU	Terminal Control Unit
TCU	Towering Cumulus
•TDA	Temporary Danger Area
TDO	Tornado
TDZ	Touchdown Zone
TECR	Technical Reason
TEL	Telephone
+TEMPO	Temporary, Temporarily
TEND	Trend, Tending to
•TERM	Terminal
•TERMA	Terminal Australia
TFC	Traffic
•TFR	Terrain Following RADAR
TGL	Touch and Go Landing
•TH	Thursday
THR	Threshold

THRU	Through
THU	Thursday
•TI	Time Interval
TIBA	Traffic Information Broadcasts by Aircraft
+TIL	Until
TKOF	Takeoff
TL...	Till (followed by time by which weather change is forecast to end)
•TLW	Time Limited WIP (work in progress)
#TMA	Terminal Control Area
•TM...	Temporary Military Operating Area (followed by identification)
TN	Indicator for Minimum Temperature (MET - used in TAF code form)
•TNS	Transitional Surface
TOC	Top of Climb
TODA	Take-off Distance Available
TOP	Cloud Top
•TOPC	Top of Climb
+TORA	Takeoff Run Available
TOX	Toxic
TP	Turning Point
•TP	Tyre Pressure
•TPC	Tactical Pilotage Chart
TR	Track
•#TRA	Temporary Restricted Area
TRANS	Transmits, Transmitter
TRL	Transition Level
•TRNG	Training
TROP	Tropopause
•TRS	Tropical Revolving Storm
TS	Thunderstorm (followed by RA=rain, SN=snow, PE=ice pellets, GR=hail, GS=small hail and/or snow pellets or combinations thereof, e.g. TSRASN=thunderstorm with rain and snow)
•TSO	Technical Standard Order
+TSUNAMI	Tsunami (used in aerodrome warnings)
•TU	Tuesday
TUE	Tuesday
TURB	Turbulence
TVA	T-Vasis
+T-VASIS	"T" Visual Approach Slope Indicator System (pronounced "TEE-VASIS")
TVOR	Terminal VOR
•TW	Tailwind
TWR	Aerodrome Control Tower or Aerodrome Control
TWY	Taxiway
TX	Indicator for Maximum Temperature (MET -used in TAF code form)

TXL	Taxilane
TYP	Type of Aircraft
TYPH	Typhoon
U	Upward (tendency in RVR during previous 10 minutes)
UA	Unmanned Aircraft
UAS	Unmanned Aircraft System
UFN	Until Further Notice
#UHF	Ultra High Frequency (300 to 3,000 MHz)
UIR	Upper Flight Information Region
•UL	Upper Limits
UNA	Unable
UNL	Unlimited
•UNICOM	Universal Communications
UNREL	Unreliable
UP	Unknown Precipitation
U/S	Unserviceable
•USA	United States of America
•USB	Upper Sideband
UTA	Upper Control Area
UTC	Coordinated Universal Time
•UTM	Universal Transverse Mercator
V	Variation from mean wind speed (MET - used in METAR/SPECI code forms)
VA	Volcanic Ash
VAAC	Volcanic Ash Advisory Centre
VAR	Magnetic Variation
+VASIS	Visual Approach Slope Indicator System
VC	Vicinity of the aerodrome (followed by FG=fog, TS=thunderstorm, FC=funnel cloud, PO=dust/ sand whirls, BLDU=blowing dust, BLSA=blowing sand or BLSN=blowing snow, eg, VCFG=vicinity fog)
VCY	Vicinity
•VDP	Visual Descent Point
#VFR	Visual Flight Rules
•VGSi	Visual Glide Slope Indicator
#VHF	Very High Frequency (30 to 300 MHz)
VHZ	Volcanic Hazard Zone
•VIA	By way of...
•VIC	Victoria
#VIP	Very Important Person
VIS	Visibility
VLF	Very Low Frequency (3 to 30 KHz)
#VMC	Visual Meteorological Conditions
#VNAV	Vertical Navigation

•VNC	Visual Navigation Chart
+VOLMET	Meteorological Information for Aircraft in Flight
#VOR	VHF Omni-Directional Radio Range (OMNI)
#VORTAC	Co-located and paired VOR and TACAN
•VR	VFR Military Training Routes
VRB	Variable
VSA	by Visual reference to the ground
•VSB	VHF Survival Beacon
VSP	Vertical Speed
•VTC	Visual Terminal Chart
VTOL	Vertical Take-Off and Landing
W	Monday to Friday
W	West, West Longitude
W	White
•WA	Western Australia
WAC	World Aeronautical Chart - ICAO 1:1,000,000 (followed by name/title)
•WAE	Workers and Equipment
W AFC	World Area Forecast Centre
•WAFS	World Area Forecast System
•WATIR	Weather and Terminal Information Reciter
WB	Westbound
WBAR	Wingbar Lights
WDI	Wind Direction Indicator
WDS PR	Widespread
•WE	Wednesday
WED	Wednesday
WEF	With Effect From, Effective From
WGS84	World Geodetic System 1984
WI	Within
WID	Width
WIE	With Immediate Effect, Effective Immediately
+WILCO	Will Comply
WIP	Work in Progress
WKN	Weaken, Weakening
WNW	West North-West
WO	Without
WPT	Waypoint
WRNG	Warning
•WS	Monday to Saturday
WS	Wind Shear
WSSO	Wing Safety and Standards Officer

WST	Western Standard Time
WSW	West South-West
WT	Weight
•WT	Wireless Telegraphy
WTSPT	Water Spout
WWW	World Wide Web
WX	Weather
WXR	Weather Radar
X	Cross
XNG	Crossing
•XW	Crosswind
XX	Heavy (used to qualify weather phenomena)
Y	Yellow
YCZ	Yellow Caution Zone
•YD	Yard
YR	Your/s
Z	Coordinated Universal Time (in meteorological messages)



GEN 2.3 CHART SYMBOLS

1. Symbols used for Australian aeronautical charts are identified on the legend of individual charts.



GEN 2.4 LOCATION INDICATORS**1. CODE ALLOCATION**

1.1 Australia follows international conventions in the allocation of codes. For locations where a landing area exists (fixed wing or helicopter), a four-letter location indicator is assigned with the first letter being a "Y". This is referred to as the "Y" code. Locations other than those given a "Y" code are identified by two, three, four or five letter codes, but to avoid confusion with location indicators, visual waypoint codes do not begin with the letter "Y". The following table summarises code allocation:

Type	Code	Example
Certified Aerodrome Aircraft Landing Area Helicopter Landing Site	4 letters (first letter "Y")	Renmark (YREN)
Navigation Aid	2 or 3 letters (2 letter codes no longer issued)	Caiguna VOR (CAG)
Visual Waypoint (as depicted on chart)	4 letters (first letter other than "Y") (3 letter codes no longer issued)	Cranbourne (CRAN)
IFR Waypoint	5 letters (3 letter codes no longer issued)	DADOP

2. LIST OF CODES

2.1 Codes are listed in ERSA GEN.



GEN 2.5 RADIO NAVIGATION AIDS

1. Australian radio navigation aids are identified in ERSA for each location under the heading NAVIGATION AIDS. Listings conform to the following sequence:

Aid	Ident	Frequency	Lat/Long	Remarks
------------	--------------	------------------	-----------------	----------------



GEN 2.6 CONVERSION OF UNITS OF MEASUREMENT
1. FUEL WEIGHT TABLES

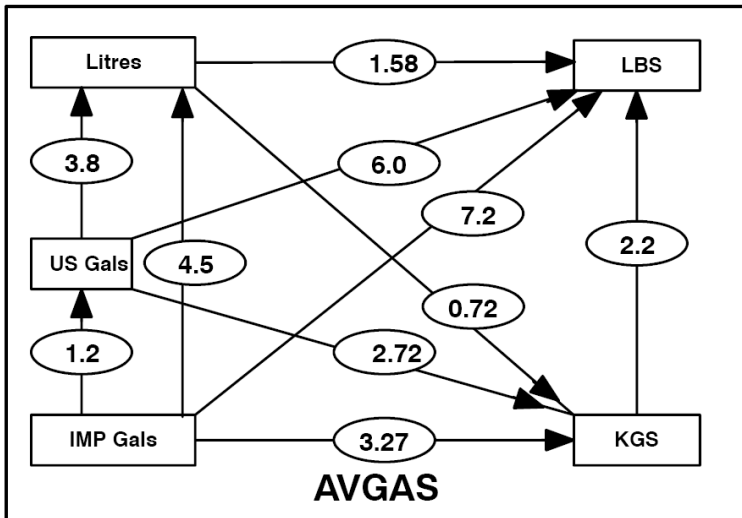
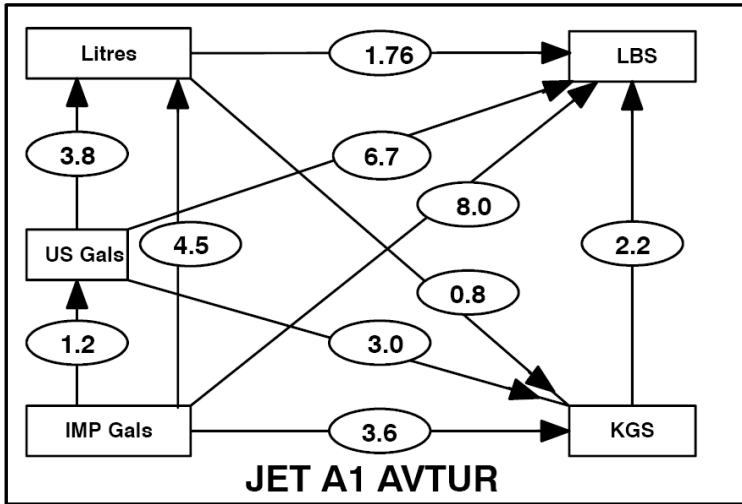

- a. To convert:
multiply by the factor in the "balloon" when moving in the direction of the arrow, or **divide** by that factor if converting in the opposite direction
- b. Fuel SG (0.8 AVTUR and 0.72 AVGAS) is based on ISA temperature at MSL. Therefore, fuel weights will be approximate for other than 15DEG Celsius

2. GENERAL CONVERSIONS

TO CONVERT	INTO	MULTIPLY BY
CELSIUS	Fahrenheit	1.8 and add 32
Centimetres	Inches	0.394
Feet	Metres	0.3048
Fahrenheit	Celsius	Subtract 32 & multiply by 0.555
Imp. Gallons	US Gallons	1.200
Imp Gallons	Litres	4.546
Inches	Centimetres	2.540
Kilograms	Pounds	2.2046
Kilometres	Nautical Miles	0.539
Kilometres	Statute Miles	0.621
Kilopascals	Pound/Square Inch	0.145
Litres	Imp Gallons	0.220
Litres	US Gallons	0.264
Metres	Feet	3.281
Metres	Yards	1.094
Pounds	Kilograms	0.4536
Pounds/Square Inch	Kilopascals	6.895
Nautical Miles	Kilometres	1.852
Nautical Miles	Metres	1852
Nautical Miles	Statute Miles	1.151
Statute Miles	Kilometres	1.609
Statute Miles	Nautical Miles	0.868
US Gallons	Imp Gallons	0.833
US Gallons	Litres	3.79
Yards	Metres	0.914

3. DECIMAL MINUTES OF AN ARC TO SECONDS OF AN ARC

MIN	SEC	MIN	SEC	MIN	SEC	MIN	SEC
0.01	0.6	0.26	15.6	0.51	30.6	0.76	45.6
0.02	1.2	0.27	16.2	0.52	31.2	0.77	46.2
0.03	1.8	0.28	16.8	0.53	31.8	0.78	46.8
0.04	2.4	0.29	17.4	0.54	32.4	0.79	47.4
0.05	3.0	0.30	18.0	0.55	33.0	0.80	48.0
0.06	3.6	0.31	18.6	0.56	33.6	0.81	48.6
0.07	4.2	0.32	19.2	0.57	34.2	0.82	49.2
0.08	4.8	0.33	19.8	0.58	34.8	0.83	49.8
0.09	5.4	0.34	20.4	0.59	35.4	0.84	50.4
0.10	6.0	0.35	21.0	0.60	36.0	0.85	51.0
0.11	6.6	0.36	21.6	0.61	36.6	0.86	51.6
0.12	7.2	0.37	22.2	0.62	37.2	0.87	52.2
0.13	7.8	0.38	22.8	0.63	37.8	0.88	52.8
0.14	8.4	0.39	23.4	0.64	38.4	0.89	53.4
0.15	9.0	0.40	24.0	0.65	39.0	0.90	54.0
0.16	9.6	0.41	24.6	0.66	39.6	0.91	54.6
0.17	10.2	0.42	25.2	0.67	40.2	0.92	55.2
0.18	10.8	0.43	25.8	0.68	40.8	0.93	55.8
0.19	11.4	0.44	26.4	0.69	41.4	0.94	56.4
0.20	12.0	0.45	27.0	0.70	42.0	0.95	57.0
0.21	12.6	0.46	27.6	0.71	42.6	0.96	57.6
0.22	13.2	0.47	28.2	0.72	43.2	0.97	58.2
0.23	13.8	0.48	28.8	0.73	43.8	0.98	58.8
0.24	14.4	0.49	29.4	0.74	44.4	0.99	59.4
0.25	15.00	0.50	30.0	0.75	45.0		

4. SECONDS OF AN ARC TO DECIMAL MINUTES OF AN ARC

SEC	MIN	SEC	MIN	SEC	MIN	SEC	MIN
1	0.02	16	0.27	31	0.52	46	0.77
2	0.03	17	0.28	32	0.53	47	0.78
3	0.05	18	0.30	33	0.55	48	0.80
4	0.07	19	0.32	34	0.57	49	0.82
5	0.08	20	0.33	35	0.58	50	0.83
6	0.10	21	0.35	36	0.60	51	0.85
7	0.12	22	0.37	37	0.62	52	0.87
8	0.13	23	0.38	38	0.63	53	0.88
9	0.15	24	0.40	39	0.65	54	0.90
10	0.17	25	0.42	40	0.67	55	0.92
11	0.18	26	0.43	41	0.68	56	0.93
12	0.20	27	0.45	42	0.70	57	0.95
13	0.22	28	0.47	43	0.72	58	0.97
14	0.23	29	0.48	44	0.73	59	0.98
15	0.25	30	0.50	45	0.75		

Note: Climb/Descent and Altitude Correction versus Temperature tables are published in AIP DAP.

5. WIND COMPONENT

WIND COMPONENT TABLE										
For crosswind component										
Angle Between Wind Direction and Runway Heading										
		10	20	30	40	50	60	70	80	90
W i n d s p e e d k n o t s	5	1	2	2	3	4	4	4	5	5
	10	2	3	5	6	7	8	9	9	10
	15	3	5	7	9	11	13	14	14	15
	20	3	7	10	13	15	17	18	19	20
	25	4	8	12	16	19	22	23	24	25
	30	5	10	15	19	23	26	28	29	30
	35	6	12	17	22	26	30	32	34	35
	40	7	14	20	25	30	35	37	39	40
	45	8	15	22	29	34	39	42	44	45
	50	9	17	25	32	38	43	47	49	50
	55	10	19	27	35	42	48	52	54	55
	60	10	20	30	38	46	52	56	59	60
	65	11	22	32	42	50	56	61	64	65
	70	12	24	35	45	54	60	66	69	70
	75	13	26	37	48	57	64	70	73	75
	80	14	27	40	51	60	69	75	78	80
		80	70	60	50	40	30	20	10	0
For Headwind Component										
Angle Between Wind Direction and Runway Heading										



GEN 2.7 FIRST LIGHT AND LAST LIGHT COMPUTATIONS

1. For all intents and purposes, 'first light' should be construed as the beginning of morning civil twilight, and 'last light' as the end of evening civil twilight.
2. To compute first light and last light using the graphs contained in this section:
 - a) enter the top or bottom of the scale at the appropriate date;
 - b) move vertically up or down to the curve for the latitude of the place concerned (interpolating for intermediate latitudes if necessary);
 - c) move horizontally to the left or right and read local mean time on the vertical scale at the side;
 - d) to convert to UTC, subtract (in E longitudes) from the LMT obtained, the time increment corresponding to the longitude of the place concerned in the "Conversion of Arc to Time" table.
 - e) to convert to EST, add 10 hours to UTC;
 - f) to convert to CST, add 9.5 hours to UTC;
 - g) to convert to WST, add 8 hours to UTC.

Example: To determine last light at Echuca (360900S 1444600E) on 20th November.

Using the graph, enter at 20th November at the top of the page and follow downwards to latitude 36° (by interpolation), then horizontally to the left and read off LMT = 1919. To convert to UTC, enter the "Conversion of Arc to Time" table, at longitude 144° (9 hours 36 minutes). Add the increment corresponding to 46' in the right hand column

$$= 3' 04'' + 0936 = 0939.$$

Subtract this from the LMT found: $1919 - 0939 = 0940$ UTC.

To find EST add 10 hours to UTC=1940 EST.

Users of these graphs should note that the parameters used in compiling the Time of First Light/Last Light Graphs do not include the nature of the terrain surrounding a location, or the presence of other than a cloudless sky and unlimited visibility at that location. Consequently, the presence of cloud cover, poor visibility or high terrain to the west of an aerodrome will result in last light occurring at a time earlier than that extracted from the appropriate graph. Allowance should be made for these factors when planning a flight having an ETA near the time of last light.

3. NAIPS automatically computes first light and last light. This information can be provided through pilot access, as part of a telephone briefing, or from FLIGHTWATCH.
4. Sunrise, sunset and civil twilight times (first and last light) can also be obtained from www.ga.gov.au/geodesy/astro/sunrise.jsp.
5. **Local Time.** Local time in Australia falls into three separate zones:

Time Zone	Local Time	States
Eastern Standard Time (EST)	UTC + 10 hours	New South Wales* (except the Broken Hill area), Queensland, Victoria*, Tasmania* and the Australian Capital Territory*
Central Standard Time (CST)	UTC + 9 ½ hours	South Australia*, the Northern Territory and the Broken Hill area*
Western Standard Time (WST)	UTC + 8 hours	Western Australia

*Note: * Daylight Saving Time applies between October of one year and April of the following year, which adds an additional hour to the local time of that State or area. NOTAM or AIP Supplements will be issued detailing revised hours of operation during Daylight Saving Time where such hours are not already promulgated in AIP.*

6. CONVERSION OF ARC TO TIME

DEGREES				MINUTES			
	Time		Time		Time		Time
Long Deg	Hours Min	Long Deg	Hours Min	Long Min	Min Sec	Long Min	Min Sec
110	7 20	135	9 00	0	0 00	30	2 00
111	7 24	136	9 04	1	0 04	31	2 04
112	7 28	137	9 08	2	0 08	32	2 08
113	7 32	138	9 12	3	0 12	33	2 12
114	7 36	139	9 16	4	0 16	34	2 16
115	7 40	140	9 20	5	0 20	35	2 20
116	7 44	141	9 24	6	0 24	36	2 24
117	7 48	142	9 28	7	0 28	37	2 28
118	7 52	143	9 32	8	0 32	38	2 32
119	7 56	144	9 36	9	0 36	39	2 36
120	8 00	145	9 40	10	0 40	40	2 40
121	8 04	146	9 44	11	0 44	41	2 44
122	8 08	147	9 48	12	0 48	42	2 48
123	8 12	148	9 52	13	0 52	43	2 52
124	8 16	149	9 56	14	0 56	44	2 56
125	8 20	150	10 00	15	1 00	45	3 00
126	8 24	151	10 04	16	1 04	46	3 04
127	8 28	152	10 08	17	1 08	47	3 08
128	8 32	153	10 12	18	1 12	48	3 12
129	8 36	154	10 16	19	1 16	49	3 16
130	8 40	155	10 20	20	1 20	50	3 20
131	8 44	156	10 24	21	1 24	51	3 24
132	8 48	157	10 28	22	1 28	52	3 28
133	8 52	158	10 32	23	1 32	53	3 32
134	8 56	159	10 36	24	1 36	54	3 36
				25	1 40	55	3 40
				26	1 44	56	3 44
				27	1 48	57	3 48
				28	1 52	58	3 52
				29	1 56	59	3 56

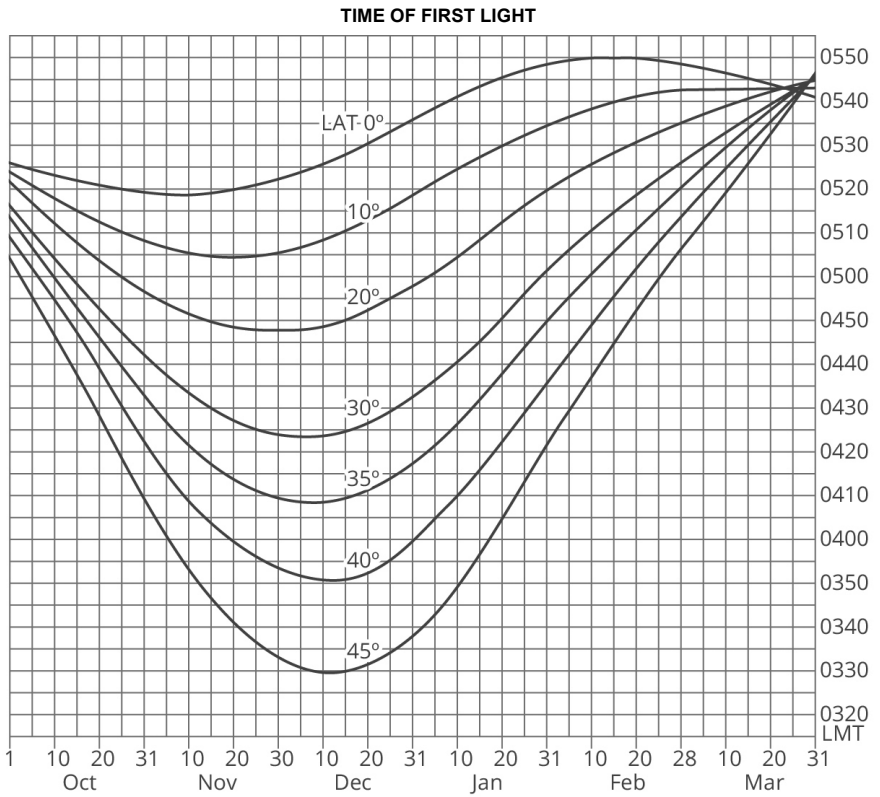

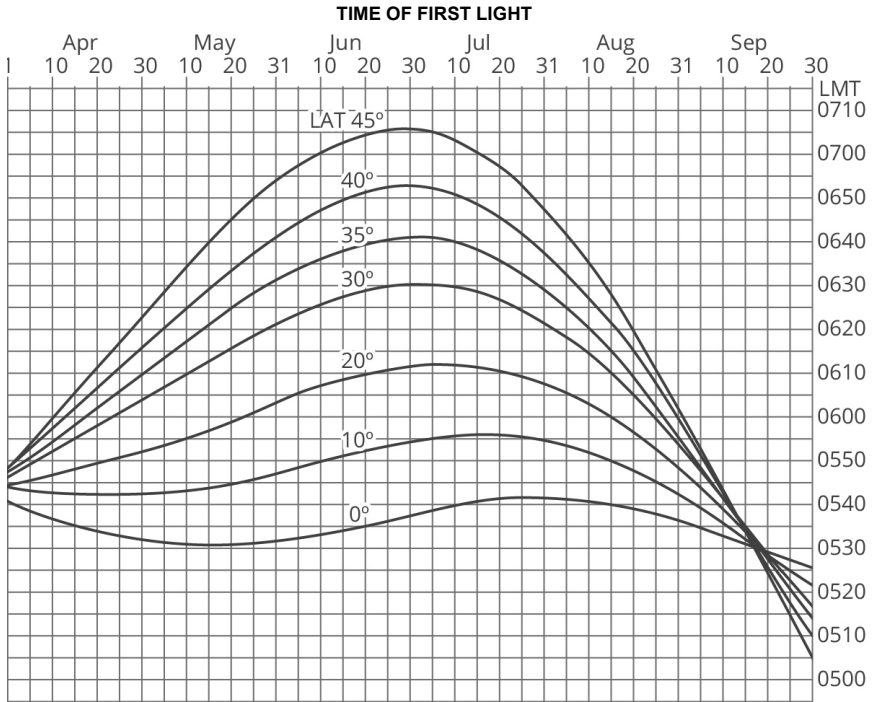

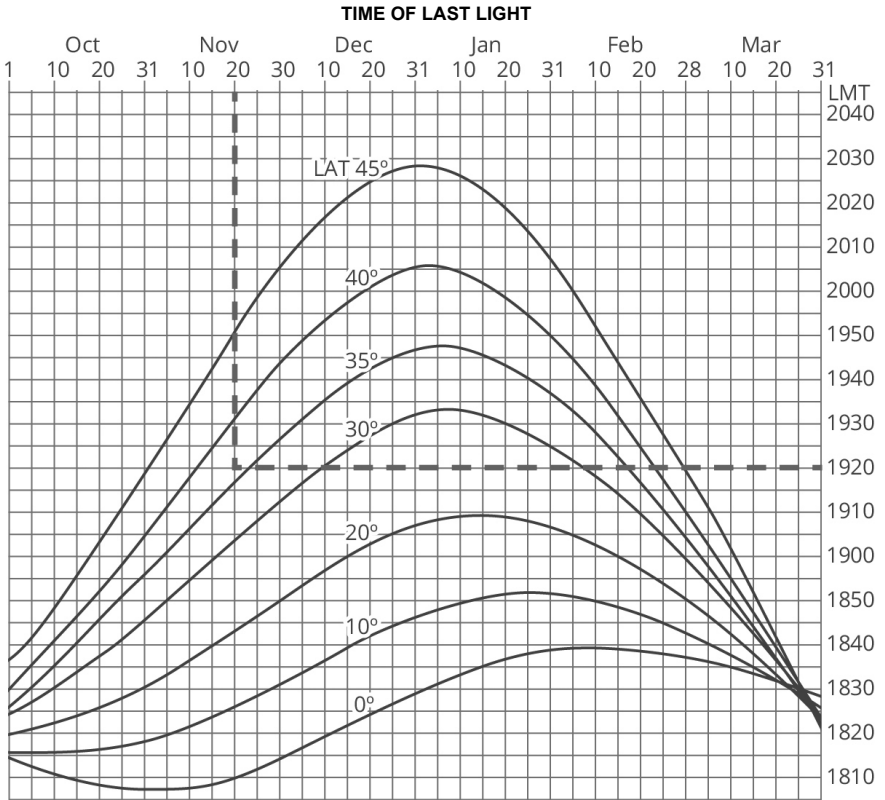

TIME OF LAST LIGHT

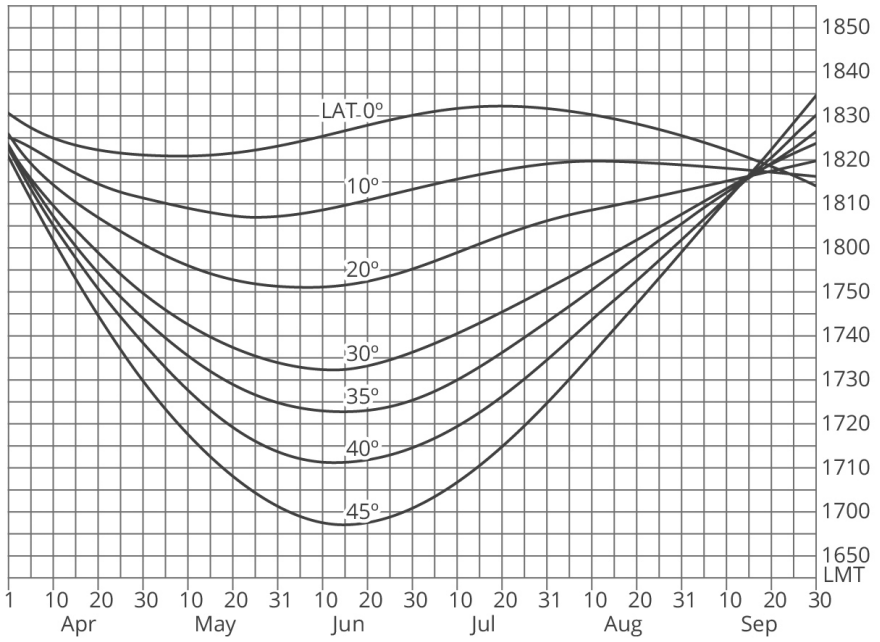

GEN 3.1 AERONAUTICAL INFORMATION SERVICES

1. ADF - AERONAUTICAL AUTHORITY

1.1 The Civil Aviation Safety Authority (CASA) and Airservices Australia are responsible for civil aviation in Australia and its Territories. CASA is responsible for safety regulation of all civil aviation in Australia, including the safety regulation of Airservices Australia provision of support services.

1.2 The AIS-AF contact details are:

Commanding Officer
Aeronautical Information Service - Air Force (AIS-AF)
VBM-M-2
Victoria Barracks
St Kilda Road
SOUTHBANK
VIC 3006
AUSTRALIA
☎: +61 3 9282 6631
FAX: +61 3 9282 6695

2. ADF - AERONAUTICAL INFORMATION SERVICE

2.1 AIS-AF is responsible for the collection, collation and dissemination of aeronautical information and instructions relating to the safety, regularity and efficiency of air operations by the ADF.

2.2 **Area of Responsibility.** AIS-AF is responsible for the provision of aeronautical information to the ADF, for the entire globe. This is achieved through means including, but not limited to, the collection and interpretation of raw data, and the purchase and distribution of domestic and foreign AIP.

3. ADF - PUBLISHED AERONAUTICAL INFORMATION

3.1 General

3.1.1 The ADF AIP provides the primary source of information concerning rules of the air and procedures for the safe and efficient movement of military aircraft in Australian airspace. The ADF AIP may be overridden by appropriately authorised orders and instructions issued by commanders.

3.1.2 AIS-AF publishes a Hazard Log on its website and portal (<http://dmet/raaf/AirForce/AIS-AF/Pages/Aviation%20Safety.aspx>) which identifies hazards associated with the production and distribution of AI and assists users to eliminate risks so far as reasonably practicable (SFARP). This is achieved by communicating any potential hazards resulting from AIS-AF processes to ensure stakeholders are aware of the identified hazards and the residual risk associated with AI that is either 'created by' or 'sourced by' AIS-AF. The characterisation of risk in the AIS-AF Hazard Log is guidance only for stakeholders and is not necessarily the risk level applicable to each platform. AIS-AF is not qualified to quantify risk for any given platform and as such, users should decide whether they generate risks in their own Risk Management Plan (RMP)/Mission Risk Profile (MRP) as a result. The final Risk Level must be determined for each platform after consideration of extant treatments or after additional mitigations are introduced.

3.2 Aeronautical Information Publication (AIP) Australia

3.2.1 The AIP is the basic aviation document intended primarily to satisfy international requirements for the exchange of permanent aeronautical information and long duration temporary changes essential for air navigation. AIP Australia is published in:

- Aeronautical Information Publication (AIP Book);
- Departure and Approach Procedures (DAP);
- En Route Supplement Australia (ERSA);
- Designated Airspace Handbook (DAH) and
- Maps and Charts.

3.2.2 The AIP is published in English only for use in international and domestic operations whether commercial or private.

3.3 Amendment Service to the AIP (AIP AMDT)

3.3.1 Amendments to AIP Book, DAP and ERSA are normally issued quarterly in accordance with AIRAC and include check lists of all current effective pages of the document (excluding ERSA).

3.3.2 Amendments to DAH, Maps and Charts (other than WAC) are normally issued biannually around May and November. New information and changes are identified by a vertical black line (revision bar). Deletions within the AIP Book have a "D" added to the vertical line. Amendments to the Table of Contents are not identified by a revision bar. New or revised information published in DAP charts will be advised in the chart margin.

3.3.3 Amendments to DAH and ERSA are issued as a separate complete product.

3.4 Supplement to the AIP (AIP SUP)

3.4.1 Temporary changes of long duration (three months and longer) and information of short duration which consists of extensive text and/or graphics, supplementing the permanent information contained in the AIP, are published as AIP SUP. Operationally significant temporary changes to the AIP are published in accordance with the AIRAC system and its established effective dates and are identified clearly by the acronym AIRAC AIP SUP. AIP SUP are distributed via the Airservices website with an associated Trigger NOTAM valid for 14 days.

3.4.2 A check list (summary) of current AIP SUP is issued monthly.

3.5 NOTAM

3.5.1 **ADF** - Only authorised individuals, using Defence group mailboxes registered with Airservices Australia, may send a NOTAM request to Airservices Australia. ADF generated NOTAM requests that relate to aerodrome facilities and will effect a permanent change to AIP or ADF FLIP (e.g. ERSA, TERMA, FAP ACG etc.) must be sent to AIS-AF (ais.notam@defence.gov.au) for review and forwarding to the NOTAM Office. Urgent or temporary NOTAM requests may be submitted directly to the NOTAM Office, with an information copy sent to advise AIS-AF.

3.5.2 NOTAM supplements AIP, providing rapid distribution of information of direct operational significance.

Note: For information about date and time used in NOTAM, see GEN 2.1 para 2.2.

In Australian Domestic distribution only, NOTAM series and their respective categories are

- 'B' series for Domestic NOTAM - ATS category only
- 'C' series for Domestic NOTAM - All other categories

3.5.3 In the international environment, Australia issues NOTAM against a series of registers. These registers are:

- individual FIR
- multiple FIR or
- Australia General.

The individual FIRs and multiple FIRs registers are further subdivided by NOTAM category. The series are as follows:

Brisbane FIR - SUA NOTAM category	D
Brisbane FIR - AD NOTAM category	J
Brisbane FIR - ATS NOTAM category	K
Brisbane FIR - all other NOTAM category	N
Melbourne FIR - SUA NOTAM category	E
Melbourne FIR - AD NOTAM category	H
Melbourne FIR - ATS NOTAM category	L
Melbourne FIR - all other NOTAM category	F
Australia General FIR	G
Jakarta FIR - all NOTAM categories for Christmas Island	I
Auckland Oceanic FIR - all NOTAM categories for Norfolk Island	M

3.5.4 **NOTAM and valid AIP element checklist.** A checklist of valid NOTAM is issued monthly (on the 1st of the month) via NAIPS. This NOTAM also identifies the elements of AIP effective on that date, including a list of AIP SUP and AIC.

3.5.5 **ADF - DINS.**Users of the NGA Digital Aeronautical Flight Information File (DAFIF) and AIS-AF's associated AusDAFIF products should check NGA's Defense Internet NOTAM Service (DINS), particularly in regard to coded Instrument Flight Procedures, for notification of errors, omissions or procedures withdrawn from the global DAFIF dataset. This is due to NGA having differing publication update cycles to the National Authorities, thus requiring NGA to amend or withdraw any coded procedures that do not reflect the latest published procedures.

4. AIRAC SYSTEM

4.1 In order to control and regulate the operationally significant changes requiring amendments to aeronautical charts, route listings, etc., such changes will generally be issued on predetermined dates according to the Aeronautical Information Regulation and Control (AIRAC) system. This type of information will normally be published as a planned AIP amendment or an AIRAC Airservices Australia SUP. In circumstances in which AIRAC notification should be given, but a normal AIP amendment or an Airservices Australia SUP cannot be produced due to a lack of time, a non-AIRAC Airservices Australia SUP or NOTAM will be issued.

4.2 The following table indicates AIRAC effective dates for the coming years. AIRAC information will be issued so that the information will be received by the user not later than 28 days before the effective date. In some circumstances of major change, AIRAC notice of 56 days may be given.

4.3 Documents and charts issued in accordance with the AIRAC cycle become effective at 1600 hours UTC on the day prior to the nominated date unless otherwise notified.

4.4 At each AIRAC effective date, a Head Office Trigger NOTAM will be issued which identifies the elements of the AIP effective on that date and their respective 'with effect' dates.

AIRAC Effective Dates			
2025	2026	2027	2028
23 Jan	22 Jan	21 Jan	20 Jan
20 Feb	19 Feb	18 Feb	17 Feb
20 Mar	19 Mar	18 Mar	16 Mar
17 Apr	16 Apr	15 Apr	13 Apr
15 May	14 May	13 May	11 May
12 Jun	11 Jun	10 Jun	08 Jun
10 Jul	09 Jul	08 Jul	06 Jul
07 Aug	06 Aug	05 Aug	03 Aug
04 Sep	03 Sep	02 Sep	31 Aug
02 Oct	01 Oct	30 Sep	28 Sep
30 Oct	29 Oct	28 Oct	26 Oct
27 Nov	26 Nov	25 Nov	23 Nov
25 Dec	24 Dec	23 Dec	21 Dec

5. ADF - PREFLIGHT INFORMATION SERVICE

5.1 A preflight information service is provided from the National Operations Management Centre (NOMC) Pilot Briefing Office, located in Canberra. Detailed information is published in the Preflight Information and Flight Planning Manual, available online:

www.airservicesaustralia.com/aip/aip.asp and
www.airservicesaustralia.com/industry-info/flight-briefing/,

A preflight information service for ADF operations is available on the following numbers:

☎ 1800 249 030 or 02 6268 5062
FAX: 1800 816 089

5.2 A description of the preflight information service available in Australia is contained in ERSA GEN.

6. DIGITAL DATA SETS

6.1 Airservices provides Vertical Obstacle Data (VOD) for:

- a. Area 1 – Australian data collected and maintained as defined in *ICAO Annex 15*, and
- b. Area 2 – All designated international aerodromes (excluding Horn Island), as listed in *GEN 1.2. Section 2*.

6.2 Information on how to order this data is available from the Airservices website: www.airservicesaustralia.com/industry-info/aeronautical-information-management/electronic-data

6.3 Terrain data is available from Geoscience Australia via their online store: elevation.fsdf.org.au

6.4 Obstacle data in the vicinity of aerodromes is collated and provided by the airport operator and is published as ICAO Type A/B charts. Terrain data for precision approach runways is also collected by the airport operator and published as Precision Approach Terrain Charts. The aerodromes where this information is available, and the airport contact details are available on the Airservices website: www.airservicesaustralia.com/aip/aip.asp

6.5 US Digital Vertical Obstruction File (DVOF) is used in various ADF aircraft systems. DVOF does not contain the complete set of Australian VO data, therefore, some Australian VOs may be omitted from aircraft systems.

6.6 VO datasets are compiled from a variety of sources and may not contain every vertical obstruction.

GEN 3.2 AERONAUTICAL CHARTS

1. CHART SERIES

1.1 Aeronautical Chart Series Available

1.1.1 The following series aeronautical charts are produced:

Planning Chart Australia (PCA);
World Aeronautical Chart (WAC);
Visual Terminal Chart (VTC);
Visual Navigation Chart (VNC);
En Route Chart - Low (ERC-Low);
En Route Chart - High (ERC-High);
Terminal Area Chart (TAC);
Aerodrome (AD) chart;
Apron chart;
Noise Abatement Procedures;
Standard Instrument Departure (SID) chart;
Standard Instrument Arrival (STAR) chart;
DME and GNSS Arrival chart;
Instrument Approach and Landing (IAL) chart; and
Aerodrome Obstruction chart (Type A) - available from the aerodrome operator.

1.1.2 The following charts are routinely made available to aircrew by AIS-AF in addition to the Airservices

Australia charts listed above:
Terminal Australia (TERMA)
Tactical Pilotage Charts – TPC
Operational Navigation Charts – ONC
Jet Navigation Charts – JNC
Joint Operations Graphics – Air (JOG – AIR)
Global Navigation Charts
Military Aerodrome Obstruction Charts (Type A)

1.1.3 Maximum Elevation Figures (MEF) depicted on charts (e.g. JOG-A, TPC and ONC) are based on vertical obstructions (VO) existing at the time of production. Newly constructed VOs reported after the production date have not been considered in the MEF calculation. Therefore some MEFs may be incorrect due to the erection of new structures.

1.1.4 Current Australian and international VO data is available through mission planning systems provided on a 28 day cycle.

1.2 General description of each series

1.2.1 PCA

- a. Briefing/Area QNH boundaries,
- b. GAF boundaries,
- c. WAC coverage and chart titles,
- d. location names and abbreviations,
- e. estimated FIS VHF coverage at 5,000FT and 10,000FT, and
- f. HF network boundaries.

1.2.2 **WAC (scale 1:1 000 000)**. designed for preflight planning and pilotage. They are constructed on Lambert Conformal Conic projection. Australian coverage is shown on the front of each chart.

1.2.3 **VNC (scale 1:500 000)**. Designed for operations under the VFR. They contain an aeronautical overlay of controlled airspace over a topographical base, and contain some radio communication and other navigational data appropriate for visual navigation. Map coverage is shown on the front of each chart.

1.2.4 **VTC (scale 1:250 000)**. Designed for visual operations near terminal areas. They contain some topographical detail and appropriate airspace, radio communication and navigation aid information. These charts are intended for use up to and including FL180.

Note: When planning visual navigation outside the coverage of VTC, pilots will need to refer to the appropriate VNC (if available) or IFR chart ERC Low for depiction of controlled airspace and Special Use Airspace.

1.2.5 **ERC Low**. Published in various scales to accommodate significant air traffic routes and shows controlled airspace, Special Use Airspace, air routes, ATS and radio navigation services. Aeronautical information within terminal areas may not be complete and pilots should use a TAC or a VTC.

1.2.6 **ERC High**. Designed for use by aircraft operating on transcontinental and inter-capital routes above FL200.

Note: The civil ERC H charts continue ATS routes beyond the Brisbane and Melbourne FIR boundaries into the adjacent foreign FIR. The airspace information depicted in the adjacent FIR does not include all the types of information presented in the Australian FIRs; importantly, PRD Area boundaries are not depicted.

1.2.7 **TAC**. Designed for use in terminal areas, these charts provide controlled airspace, air routes, prohibited, Special Use Airspace, navigation aids and radio frequencies. They are designed to display aeronautical information at a larger scale for easier use in congested areas. Scale varies for each chart.

1.2.8 Aerodrome charts, Apron charts, Noise Abatement Procedures, SID charts, STAR charts, DME and GNSS Arrival charts, and IAL charts are published in DAP East and DAP West and AIS-AF TERMA.

1.2.9 Obstruction charts (Type A), when required to be produced, are available from respective aerodrome owners/operators and from AIS-AF for military aerodromes.

GEN 3.3 AIR TRAFFIC SERVICES

1. RESPONSIBLE SERVICE

1.1 The responsible authorities for the provision and administration of Air Traffic Services in Australia are:

- a. Airservices Australia
GPO BOX 367
CANBERRA ACT, 2601
Australia
Email: atsintegrity@airservicesaustralia.com
Website: www.airservicesaustralia.com/about-us/ourservices/air-traffic-management/
- b. Department of Defence - Royal Australian Air Force (RAAF)
No. 44 Wing
RAAF Base Williamtown
WILLIAMTOWN NSW, 2314
Australia
Email: hqsrqa7.anspstand@defence.gov.au

1.2 The services are provided in accordance with the following ICAO documents:

- a. Annex 2
- b. Annex 11
- c. Annex 10; Vol II
- d. DOC 4444 (PANS-ATM)
- e. DOC 7030 (Regional Supplementary Procedures)
- f. DOC 8168 (PANS-OPS)
- g. DOC 9426 (ATS Planning Manual)

1.3 Differences from ICAO Standards and Recommended Practices are detailed in *GEN 1.7*.

2. AREA OF RESPONSIBILITY

2.1 Air traffic services are provided as follows:

Authority	Area of Responsibility
Airservices Australia	The territory of Australia, including territorial waters and the airspace over the high seas within the Brisbane FIR and Melbourne FIR, except: Norfolk Island and Christmas Island and associated territorial waters; and Where the Department of Defence provide services as below.
Department of Defence (RAAF)	Aerodrome services at Edinburgh and Richmond. Aerodrome and Approach services at Amberley, Darwin, East Sale, Nowra, Oakey, Pearce, Tindal, Townsville and Williamtown.

3. TYPES OF SERVICE

3.1 General

3.1.1 The following types of services are provided to ensure the safe, orderly and expeditious flow of air traffic:

- a. Air Traffic Control Service:
 - 1) En Route Control (Surveillance and Procedural);
 - 2) Approach Control (Surveillance and Procedural);
 - 3) Aerodrome Control (Tower);
- b. Flight Information Service; and
- c. Alerting Service.

3.1.2 Hours of operation, services provided, and identification of ATS units are published in *ERSA*.

3.2 Air Traffic Control Service

3.2.1 An Air Traffic Control service is provided to:

- a. all IFR flights in classes A, B, C, D and E airspace;
- b. all VFR flights in classes B, C and D airspace;
- c. all Special VFR flights in classes B, C and D airspace; and
- d. all aerodrome traffic at controlled aerodromes.

3.3 Flight Information Service (FIS)

3.3.1 Pilot Responsibility

3.3.1.1 Pilots are responsible for obtaining information necessary to make operational decisions. To ensure that accurate information is obtained in adequate time, pilots must take into consideration that ATC initiated FIS is limited to aircraft within one hours' flight time of the condition or destination at time of receipt of the information by ATC. The only exception to this is SIGMET information, which shall cover a portion of the route up to two hours' flight time ahead of the aircraft.

3.3.2 Preflight Information

3.3.2.1 The Preflight Briefing Service is available online via the NAIPS Internet Service or via telephone to the Aircservices Pilot Briefing Office on 1800 805 150. Detailed information is published in the Preflight Information and Flight Planning Manual, available online: www.airservicesaustralia.com/aip/aip.asp and www.airservicesaustralia.com/industry-info/flight-briefing/

3.3.2.2 Pilots must obtain an appropriate preflight briefing before departure from places where the above facilities are accessible. Where those facilities are not accessible, a briefing may be obtained from FLIGHTWATCH as soon as practicable after the flight commences. The information requested should be confined to data considered essential for the safe conduct of the flight to the first point of intended landing where additional information can be obtained.

3.3.2.3 Preflight briefing will not normally be provided on ATC communications channels.

3.3.3 In-flight Information

3.3.3.1 The in-flight information services consists of three elements:

- a. ATC Initiated FIS;
- b. Automatic Broadcast Services; and
- c. an On-Request Service.

3.3.4 ATC Initiated FIS

3.3.4.1 ATC provides pilots with pertinent information that will affect flight within one hour's flight time (two hours for SIGMET). At the time the information is identified, information will be directed to pilots maintaining continuous communications and broadcast on appropriate ATS frequencies.

3.3.5 Automatic Terminal Information Service (ATIS)

3.3.5.1 Operational information required by aircraft for takeoff or landing is broadcast on a dedicated frequency and/or on the voice channel of radio navigation aids.

3.3.5.2 Outside the hours of tower activation, operational information of an unchanging nature may be broadcast over ATIS.

3.3.6 Aerodrome Flight Information Service (AFIS)

3.3.6.1 An AFIS provides pilots with an alerting service, local traffic and operational information on the CTAF assigned to the particular aerodrome.

3.3.6.2 Essential aerodrome information is provided by an Automatic Aerodrome Information Service (AAIS) broadcast on a dedicated frequency (similar to ATIS) during AFIS HRS.

3.3.7 Surveillance Flight Information Service (SFIS)

3.3.7.1 An SFIS provides a pilot with traffic information within a mandatory broadcast area using the aerodrome's Common Traffic Advisory Frequency (CTAF). The SFIS is not a separation or sequencing service.

3.3.7.2 SFIS is dependent on detection by the ATS surveillance system. This means the service cannot be provided for or about aircraft below ATS surveillance system coverage or not operating transponder or ADS-B OUT equipment.

3.3.7.3 Traffic information may be summarised or limited to generic statements e.g. number of known aircraft in the circuit. The SFIS may not be aware of the position of aircraft within the circuit.

3.3.7.4 SFIS does not relieve pilots of their see-and-avoid, SARWATCH and SARTIME responsibilities.

3.3.8 Traffic Information

3.3.8.1 A traffic information service is provided, depending on higher priority duties of the controller or other limitations; e.g. surveillance limitations, volume of traffic and/or frequency congestion. Additionally, controllers may not be able to provide traffic information concerning all traffic in the aircraft's proximity. Traffic information does not relieve pilots of their responsibility to see and avoid other aircraft.

3.3.8.2 In Class G airspace, a traffic information service is provided to IFR flights about other conflicting IFR and observed VFR flights except:

- a. An IFR flight reporting taxiing or airborne at a non-controlled aerodrome will be advised of conflicting IFR traffic that is not on the CTAF; and
- b. An IFR flight inbound to a non-controlled aerodrome will be advised of conflicting IFR traffic until the pilot reports changing to the CTAF.

3.3.8.3 A Surveillance Information Service (SIS) is available on request, to VFR flights in classes E and G airspace within ATS surveillance system coverage, subject to ATC workload. Pilots receiving a SIS are provided with traffic information, an alerting service and on request position or navigation information.

Note: All information is advisory in nature. The pilot remains responsible for terrain clearance, aircraft-to-aircraft separation and obtaining clearances into controlled airspace.

3.3.8.4 Pilots wishing to receive a SIS must be in direct VHF communications with ATC and equipped with a serviceable SSR transponder or ADS-B transmitter. The pilot must maintain a continuous listening watch with ATC, advise ATC prior to any changes to track or level and advise prior to leaving the frequency.

3.3.8.5 SIS may be terminated at any time by the controller, or by pilot advice.

3.3.9 On-Request Service - ATC and FLIGHTWATCH

3.3.9.1 An On-Request FIS is available to aircraft in all classes of airspace on ATC VHF or HF frequencies.

3.3.9.2 Information derived from BoM weather radar sites is available to pilots on request, subject to ATS workload.

3.4 Alerting service

3.4.1 An Alerting Service will be provided:

- a. for all aircraft provided with ATC service;
- b. in so far as practicable, to all other aircraft having filed a flight plan or otherwise known to the air traffic services; and
- c. to any aircraft known or believed to be the subject of unlawful interference.

3.5 Safety Alerts and Avoiding Action

3.5.1 ATC will issue a Safety Alert to aircraft, in all classes of airspace, when they become aware that an aircraft is in a situation that is considered to place it in unsafe proximity to:

- a. terrain;
- b. obstruction;
- c. active restricted or prohibited areas; or
- d. other aircraft.

3.5.2 When providing an ATS surveillance service, ATC will issue avoiding action advice as a priority, when they become aware that an aircraft is at risk of collision with another aircraft.

4. CALCULATION OF LOWEST SAFE ALTITUDE (LSALT)

4.1 Pilot Responsibilities

4.1.1 A pilot using Grid LSALT for obstacle clearance is responsible for determining the allowance for navigation error that should be applied, considering the limitations of the navigation aids or method of navigation being used for position fixing. This navigation error allowance must be applied to the proposed track. The highest Grid LSALT falling within the area covered by the determined navigation error must be used.

4.1.2 For routes and route segments not shown on Airservices Australia AIP aeronautical charts, the lowest safe altitude must not be less than that calculated in accordance with paragraph 4.1.3 within an area defined in the following paragraph 4.1.6, 4.1.7, 4.1.8 and 4.1.9.

4.1.3 Unreported obstacles up to 360FT may exist in navigation tolerance areas. The LSALT must be calculated using the following method:

- a. where the highest obstacle is more than 360FT above the height determined for terrain, the LSALT must be 1,000FT above the highest obstacle; or
- b. where the highest obstacle is less than 360FT above the terrain, or there is no charted obstacle, the LSALT must be 1,360FT above the elevation determined for terrain; except that
- c. where the elevation of the highest terrain or obstacle in the tolerance area is not above 500FT, the LSALT must not be less than 1,500FT AMSL.
- d. **ADF** - the calculated LSALT is to be rounded up to the nearest hundred feet.

4.1.4 **ADF** - An aircraft must not be flown under the IFR, lower than the published lowest safe altitude or the lowest safe altitude calculated in accordance with this section, unless the operation is specifically approved by the MAO (e.g. use of NVIS).

4.1.5 If the navigation of the aircraft is inaccurate, or the aircraft is deliberately flown off track, or where there is a failure of any radio navigation aid normally available, the area to be considered is a circle centred on the DR position, with a radius of 5NM plus 20% of the air distance flown from the last positive fix.

4.1.6 **For Routes Defined by Radio Navigation Aids or to be Navigated by DR:** the area to be considered must be within an area of 5NM surrounding and including an area defined by lines drawn from the departure point or en route radio aid, 10.3° each side of the nominal track (where track guidance is provided by a radio navigation aid), or 15° each side of the nominal track (where no track guidance is provided) to a limit of 50NM each side of track, thence paralleling track to abeam the destination and then converging by a semicircle of 50NM radius centred on the destination. On shorter routes, where these lines are displaced by less than 50NM abeam the destination, they shall converge by a radius based on that lesser distance. Where the lines thus drawn come at any time within the coverage of an en route or destination radio aid the aircraft is equipped to use, they will converge by straight lines to that aid. The minimum angle of convergence which must be used in this case is 10.3° each side of track.

4.1.7 **For Routes Operated under the RNP 2 Navigation Specification:** the area to be considered must be within an area of 5NM surrounding and including the departure point, the destination and each side of the nominal track.

4.1.8 **For Other Area Navigation Operations:** the area to be considered must be within an area of 5NM surrounding and including an area defined by lines drawn from the departure point not less than 15° each side of the nominal track to a maximum of:

- a. 8NM for a flight under the RNP 4 navigation specification;
- b. 7NM for a flight under an RNAV navigation specification having a GNSS input; or
- c. 30NM for a flight under a non-GNSS area navigation specification.

Thence paralleling track to abeam the destination and converging by a semicircle of the same radius centred on the destination.

4.1.9 **VFR Flights at Night.** The area to be considered must be:

- a. the area specified in *para 4.6, 4.7 or 4.8* for aircraft navigated by means of a radio navigation system; or
- b. within a radius of 10NM from any point along the aircraft's nominal track.

However, the pilot who has positively determined by visual fix that a critical obstruction has been passed may nevertheless descend immediately to a lower altitude, provided that the required obstacle clearance above significant obstructions ahead of the aircraft is maintained.

4.1.10 ADF - An aircraft must not be flown under the VFR at night, lower than the published lowest safe altitude or the lowest safe altitude calculated in accordance with this section unless the operation is specifically approved by the MAO (eg use of NVIS).

4.1.11 **RAN - Commanders of Naval Air Squadrons** may, if it is considered operationally essential in accordance with Naval Aviation Standing Instructions - SI(NA), authorise reduction of these minima requirements as follows:

- a. Where map data is considered unreliable, the minimum altitude tolerance is to be 2,000FT.
- b. For unaided NGT flight an altitude tolerance of not less than 500FT may be used when:
 - 1) approved by the CO;
 - 2) conditions allow a VMC criteria of not less than:
 - i 5,000M visibility,
 - ii 1,500M horizontal separation from cloud, and
 - iii 1,000FT vertical separation from cloud;
 - 3) conditions are conducive to visual navigation;
 - 4) visual reference to the ground or water is maintained at all times; and
 - 5) electronic guidance is available from:
 - i the navaids detailed in AIP, or
 - ii a serviceable Doppler or GPS (TSO-129 approved).

4.2 ADF - Helicopter Destination Safety Height

4.2.1 Helicopter Destination Safety Height (HDSH) is only applicable to ADF helicopters conducting Unaided NGT Flight. The HDSH is used at airfields/landing areas that do not have a surveyed/promulgated circuit height.

4.2.2 The HDSH Effective Area (HDSHEA) is based on a 3 NM radius from the landing area. Where known terrain/obstacles are situated within the HDSHEA, an aircraft captain may reduce the HDSHEA (at the flight planning stage only) by using the figure at [paragraph 4.3.15](#), which modifies the HDSHEA, with a left or right circuit as appropriate.

4.2.3 The HDSH is calculated IAW [Section 4](#) for the obstacles within the HDSHEA, then further reduced by 500FT.

4.2.4 Descent to the HDSH may be commenced when the aircraft is visually or electronically (radio navigation aid or GPS) fixed within the HDSHEA, with the landing area lights in sight and the helicopter can be maintained within the planned HDSHEA.

4.2.5 Descent below the circuit area HDSH may only be commenced when aligned on final approach and established on glide path. The approach should be aborted and a climb commenced if visual contact with the approach aid becomes intermittent or is lost.

4.3 Explanatory Figures

4.3.1 Overlapping navigation aid coverage on route segment with each coverage half length of segment or more.

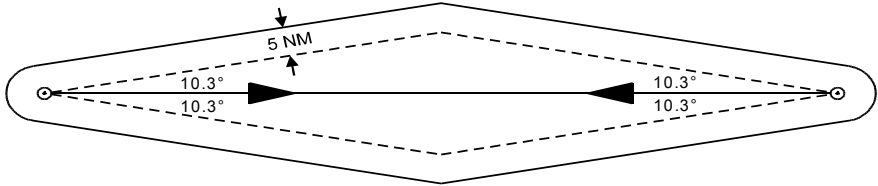

4.3.2 Coverage of destination navigation aid less than half length of segment.

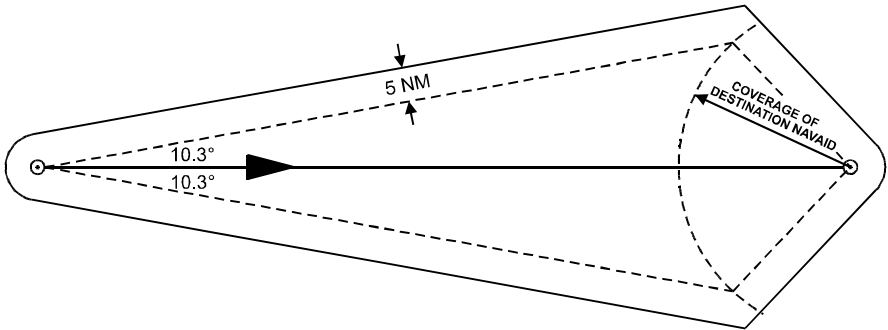

4.3.3 No navigation aid at departure aerodrome, destination navigation aid coverage such that 10.3° line intersect 15° lines from departure aerodrome.

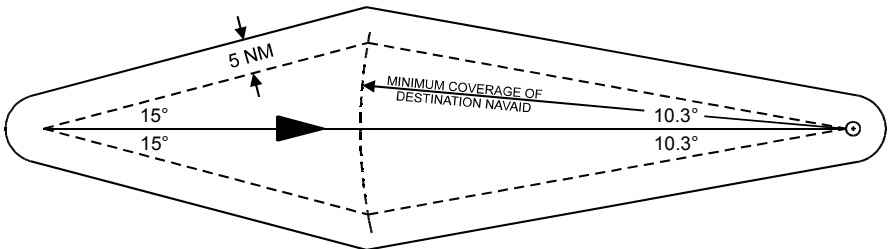

4.3.4 No navigation aid at departure aerodrome, destination navigation aid coverage such that 10.3° lines do not intersect 15° lines from departure aerodrome.

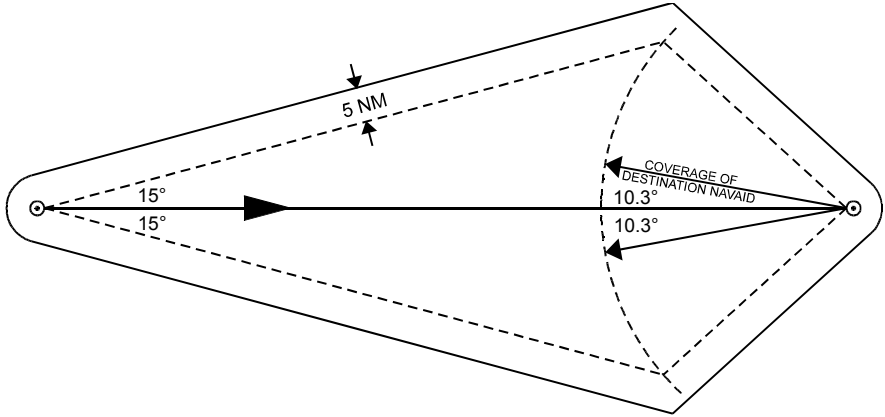

4.3.5 Navigation aid at departure aerodrome, no destination navigation aid. Segment distance not exceeding 275NM (10.3° diverges 50NM from nominal track in 275NM).

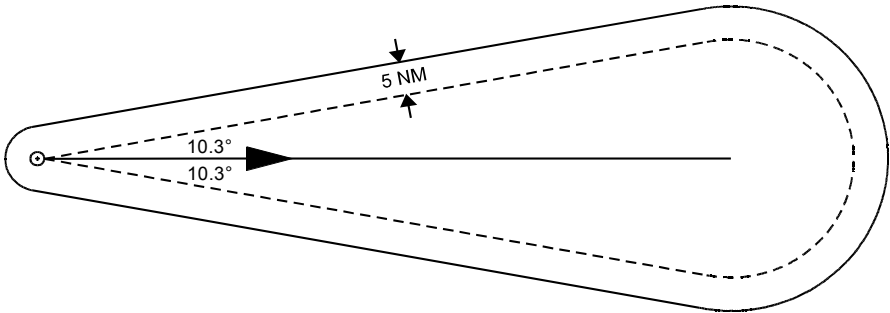

4.3.6 Navigation aid at departure aerodrome, no navigation aid at destination. Segment distance exceeding 275NM.

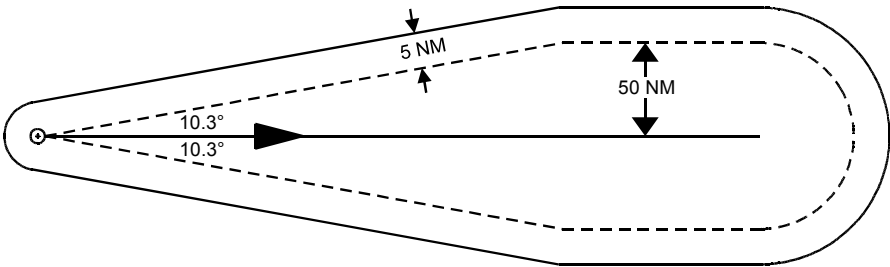

4.3.7 Route segment without navigation aids. Segment distance not exceeding 186NM (15° diverges 50NM from track in 186NM).

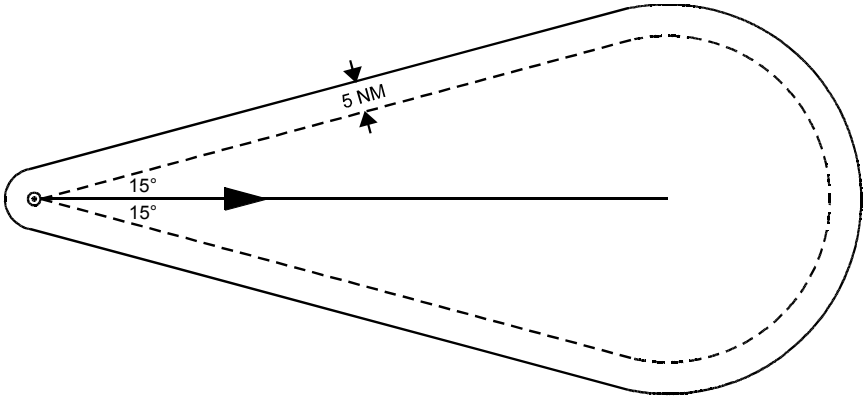

4.3.8 Route segment without navigation aids. Segment distance exceeding 186NM.

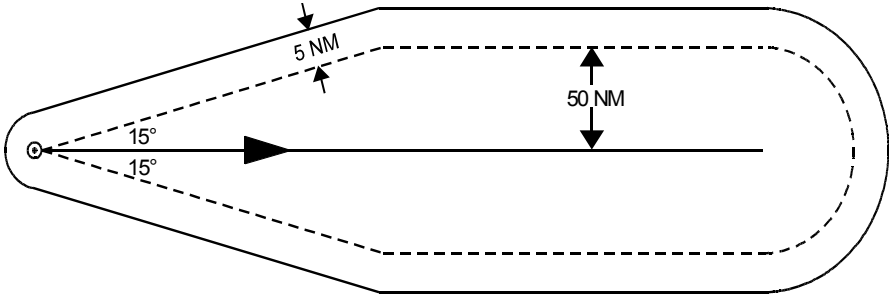

4.3.9 As for paragraph 3.5.2, but 10.3° lines expand to a maximum distance of 50NM either side of track. In no case is the maximum width of the basic area inside the 5NM buffer area greater than 50NM either side of track.

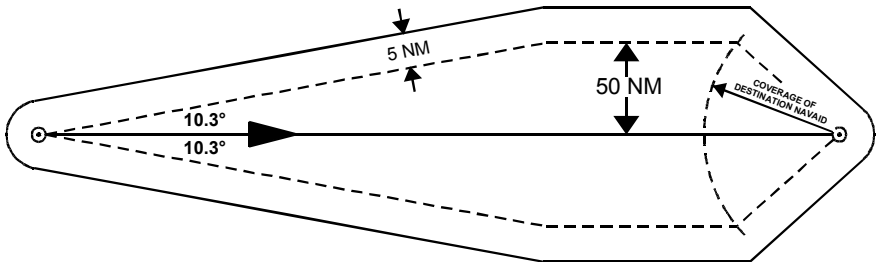

4.3.10 Route segments with intermediate reporting points (no positive fix). Basic area for A-B is ADEF and for B-C is GDCF.

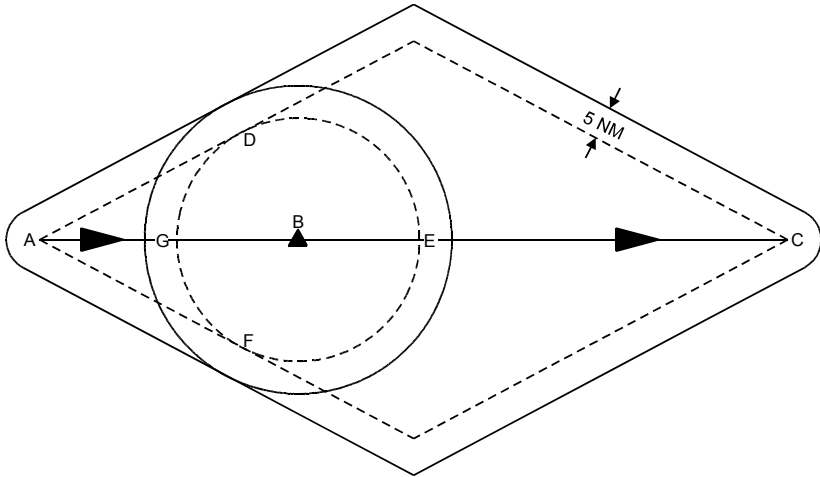

4.3.11 Route segments with change of direction at DR position. Coverage of destination navigation aid not less than length of second sector of route segment.

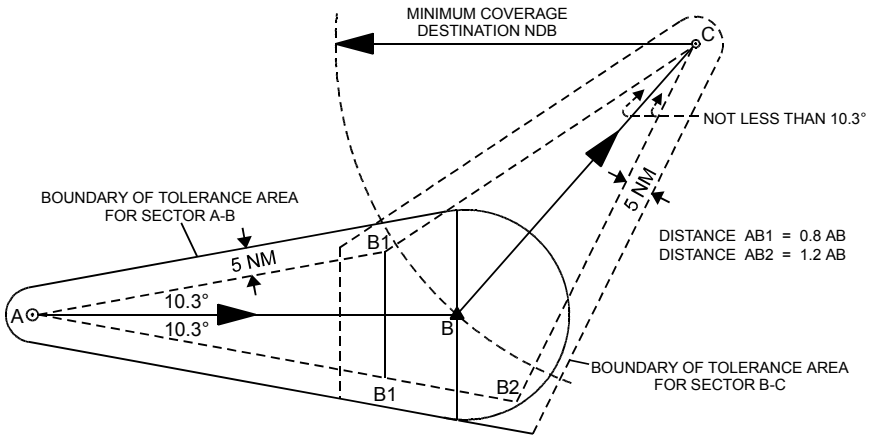

4.3.12 Route segment with change of direction at DR position. Coverage of destination navigation aid less than length of second sector of route segment.

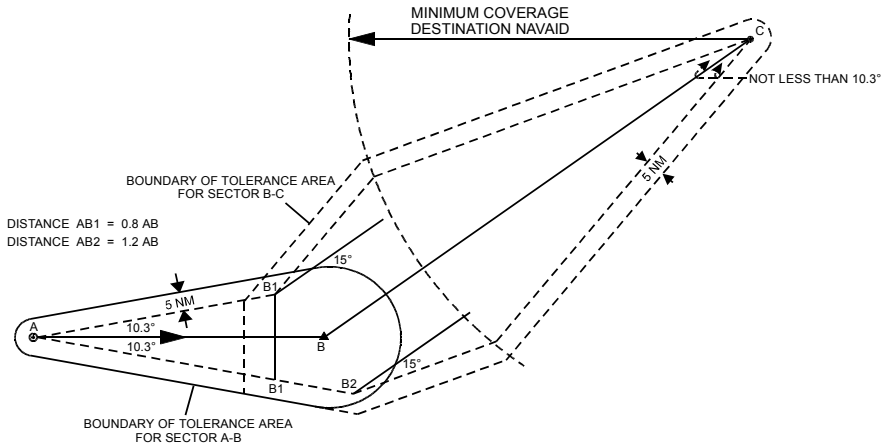

4.3.13 Route segment with change of direction at DME/azimuth aid fix. Coverage of destination navigation aid not less than length of second sector of route segment.

Note: Diagram shows DME at A. DME fix area would be different if DME at another position.

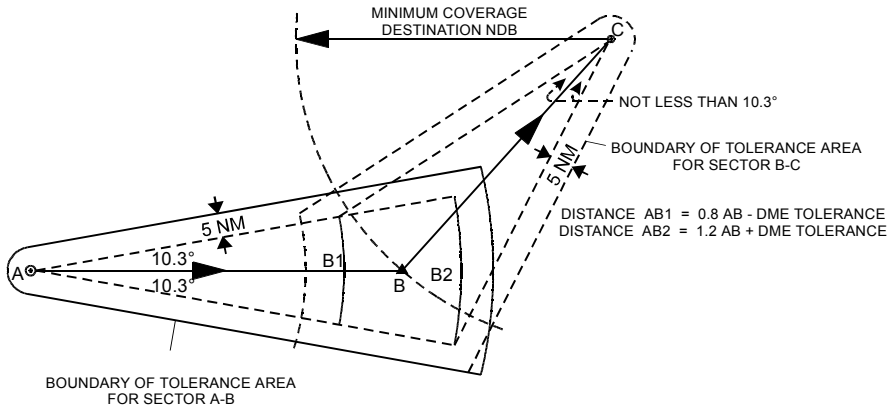

4.3.14 Route segment with change of direction at DME/azimuth aid fix. Coverage of destination navigation aid less than length of second sector of route segment.

Note: Diagram shows DME at A. DME fix area would be different if DME at another position.

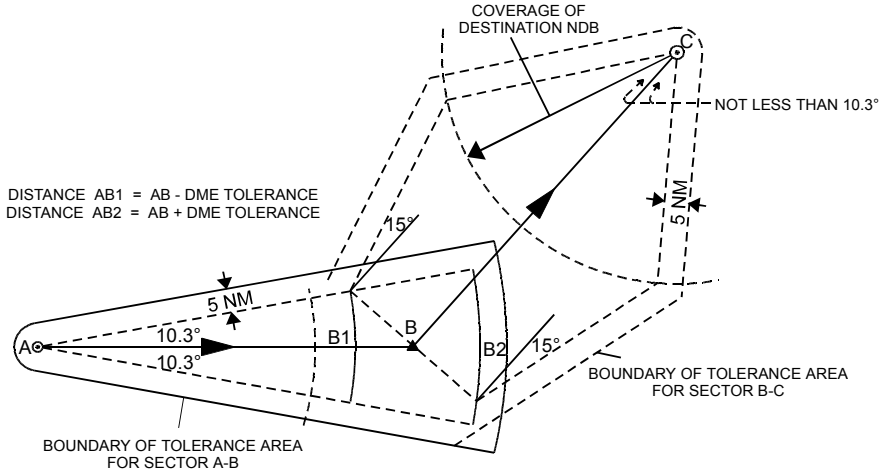

4.3.15 Unaided Night Flying - Modified Destination Safety Height Effective Area.

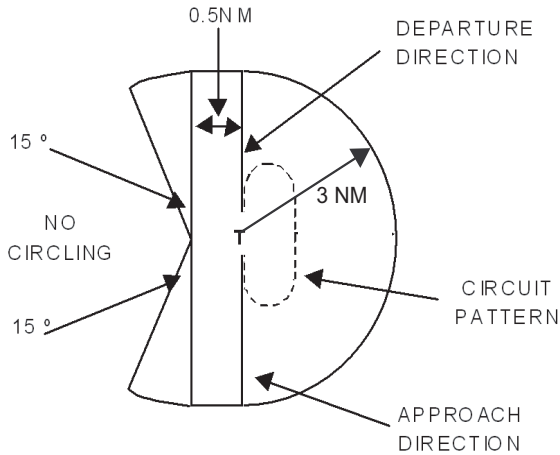

5. CONTINGENCY PROCEDURES - AIR TRAFFIC SERVICES TEMPORARILY NOT AVAILABLE

5.1 Introduction

5.1.1 When Air Traffic Services are temporarily not available traffic management, access control and/or communication procedures enhancing situational awareness and protecting against traffic saturation and frequency congestion within the affected airspace will be promulgated by NOTAM.

Note: Refer to ENR 1.1 for Procedures which may be implemented when ATS is temporarily not available.

6. CONTROL OF VEHICULAR AND PEDESTRIAN MOVEMENT ON AERODROMES

6.1 Drivers of vehicles which need to operate on the manoeuvring area must not seek permission to do so from ATC, unless the driver and vehicle holds the appropriate Driver Authority for Use Airside as issued by the airport operator and/or owner.

6.2 ATC has the authority to issue or to withhold for reasons of traffic, permission for vehicular or pedestrian movement on the manoeuvring area. When it is permitted, such movement will be rigidly controlled.

6.3 All persons, including drivers of vehicles, will be instructed to stop and hold position for radio clearances, or light signal clearances, from the tower before crossing any runway or taxiway, unless they are on a portion of the manoeuvring area marked off by lights, flags or other conventional warning signs. In radio advice to aircraft, ATC will identify as distinctly as possible, persons or vehicles on the manoeuvring area.

6.4 All persons, including drivers of vehicles, on the manoeuvring area must stop and hold at all lighted stop bars and may only proceed further when a clearance to enter or cross the runway has been received and the stop bar lights have been switched off. *(See also ENR 1.1 Section 2.4.3)*

6.5 All persons, including drivers of vehicles, required to hold short of a runway, must hold at the appropriate runway-holding position for that runway, or the runway strip edge.

6.6 All persons, including drivers of vehicles, in receipt of a clearance from ATC to enter a runway, must hold short of an intersecting runway except when an instruction "CROSS RUNWAY (number)" has been issued and the stop bar lights, where fitted, have been switched off. *(See also ENR 1.1 Section 2.4.3)*

GEN 3.4 COMMUNICATION SERVICES

1. RESPONSIBLE SERVICE

1.1 Airservices Australia (Airservices) is responsible for aeronautical communication and navigation services in Australia.

Postal Address: Airservices Australia
 25 Constitution Avenue
 CANBERRA ACT 2600
 AUSTRALIA
 Phone: +61 2 6268 4111
 Fax: +61 2 6268 5693
 Website: www.airservicesaustralia.com

1.2 A small number of assets within the aeronautical communications and navigation systems are owned by entities other than Airservices.

1.3 **Applicable ICAO Documents.** ICAO Standards, Recommended Practices and Procedures described in the following are applied to communication and navigation services provided within Australia, subject to the differences identified at *GEN 1.7*.

- Annex 10 - Aeronautical Telecommunications
- Annex 11 - Air Traffic Services
- Doc 4444 - Procedures for Air Navigation Services - Air Traffic Management (PANS-ATM)
- Doc 7030 - Regional Supplementary Procedures
- Doc 7910 - Location Indicators
- Doc 8400 - ICAO Abbreviations and Codes
- Doc 8585 - Designators for Aircraft Operating Agencies, Aeronautical Authorities and Services
- Doc 9869 - Performance Based Communications and Surveillance (PBCS) Manual
- Doc 10037 - Global Operational Data Link (GOLD) Manual

2. AREA OF RESPONSIBILITY

2.1 **Continental and Oceanic Areas.** Airservices provides communication and navigation services throughout the Brisbane (YBBB) and Melbourne (YMMM) FIR.

2.2 **External Territories.** Airservices provides communication and navigation services beyond the YBBB and YMMM FIR to the Australian external territories of Norfolk Island and Christmas Island.

2.3 **Extra Territorial Services.** Airservices provides communication services in Class A airspace within the Honiara (AGGG) and Nauru (ANAU) FIR.

3. RADIO NAVIGATION SERVICE

3.1 General

3.1.1 The following types of radio aids to navigation operate within Australian FIRs:

- a. MF Non-Directional Beacon (NDB);
- b. VHF Omni-Directional Radio Range (VOR);
- c. Distance Measuring Equipment (DME);
- d. Instrument Landing System (ILS);
- e. Primary Surveillance RADAR (PSR);
- f. Secondary Surveillance Radar (SSR);
- g. Global Navigation Satellite System (GNSS) including Global Positioning System (GPS), GLONASS, Galileo etc;
- h. GBAS Landing System (GLS) - (Polarisation GBAS/H);
- i. Tactical Air Navigation System (TACAN) (military locations);
- j. Automatic Dependent Surveillance - Contract (ADS-C) (FANS-1/A); and
- k. Automatic Dependent Surveillance - Broadcast (ADS-B)(1090 MHZ Extended Squitter).

3.2 Identification

3.2.1 Radio navigation aids serving the same location normally radiate the same identification codes. Further, at ILS/Localiser installations, the normal identification is preceded by the letter "I"; and at private non-accredited NDBs, a four letter identifier is radiated, the first letter being "X".

3.2.2 A GBAS station is identified by the relevant aerodrome's 4 letter ICAO code where the GBAS is installed (e.g. YSSY). Approaches provided from the GBAS station are identified by the Reference Path ID field in the Final Approach Segment (FAS) data blocks. The Reference Path ID is unique to the approach to be used and published on the Approach Plate for the runway. Each Reference Path ID commences with the letter "G".

3.3 Non-Directional Beacon (NDB)

3.3.1 Operate in the frequency band 190KHz - 1750KHz. Due to the frequency range available within Australia, a number of beacons share the same frequency. Where this occurs, the beacons are widely spaced geographically.

3.3.2 Some NDBs have been sited in mountainous country and reflections of the signal can cause bearing fluctuations which may occasionally exceed 10°. Since these fluctuations may tend to obscure the "over the top" indications, other aids should be used as a check. The rated coverage of these NDBs is generally reduced to no more than 30NM.

3.4 VHF Omni-Directional Radio Range (VOR)

3.4.1 These aids operate in the frequency band 112 - 118 MHz. The track radials are designated by their magnetic bearing away from the station.

3.5 Distance Measuring Equipment (DME)

3.5.1 Australia uses the international 1,000 MHz system. The system uses the channels designated in ICAO Annex 10 for operation with the VOR frequency selected for the same site. This "pairing" facilitates compatible airborne equipment to display both the DME and VOR information by the selection of only the VOR frequency.

3.5.2 When specific ICAO requirements are met, collocated DME and VOR are said to be "associated" and are shown in AIP documents as VOR/DME with the VOR frequency. In other cases, a bracket will be used to indicate collocation of navigation aids.

3.5.3 When a DME is not "associated" with the VOR at the same site, it is identified in NOTAM and AIP documents by its channel number and suffix with the VOR frequency in parenthesis - e.g., DME 111X (116.4).

3.6 Tactical Air Navigation Aid (TACAN)

3.6.1 TACAN systems are installed at a number of military/joint-user aerodromes. The DME element of the TACAN can be obtained by using its "paired" VOR frequency.

Note: TACAN and VOR installations at joint-user airfields are never "associated".

3.6.2 TACAN is shown in AIP aeronautical charts by the channel number with the "paired" VOR frequency - e.g., TACAN 88X (114.1).

3.7 Public Broadcasting Stations

3.7.1 Some broadcast stations are shown on visual navigation charts when they may be of value as supplementary aids to navigation.

3.8 Abnormal Operation of Radio Navigation Aids

3.8.1 Users must notify ATS of any abnormal condition in the operation of any radio navigation facility.

3.8.2 **Aids Not Available for Navigation.** Sometimes a facility that is not suitable for navigation has to be operated for test purposes. To provide a warning to pilots in such cases, in addition to NOTAM or verbal advice, the station identifier will either:

- a. be suppressed; or
- b. for ILS:
 - 1) if the Localiser is out of service, the glide path will not be radiated and there will be no identifier; or
 - 2) if the glide path is out of service but radiating test signals, the localiser will not be radiated; or
 - 3) if the glide path is out of service and switched off, the localiser may be radiated together with the station identification; or
- c. for GLS:
 - 1) when required for maintenance or on failure the system will be withdrawn from service; or
 - 2) if the audible Reference Path ID is corrupt or not received, the system will be withdrawn from service.
- d. for newly installed NDBs or experimental facilities, the identifier XP will be used.

Note: When a disabled GLS approach is selected, the Reference Path ID may still be displayed on the Primary Flight Display and the audible IDENT heard. No deviation indications or steering commands will be displayed.

3.9 Remote Facilities

3.9.1 Sometimes circumstances necessitate the introduction of a station identification before the aid is notified as being available for operational use. Whilst use of the aid in these circumstances does not present an operational hazard, navigation by use of the aid must not be planned until its availability is notified by NOTAM.

3.10 Monitoring of Identifier

3.10.1 If a station identification is not received or is corrupt, the aid should not be used as the primary means of navigation except when its serviceability in this condition is confirmed by NOTAM.

3.11 Global Navigation Satellite System (GNSS)

3.11.1 GNSS is a worldwide satellite navigation service comprising of one or more satellite constellations, including GPS, aircraft receivers and integrity monitoring, augmented as necessary to achieve specific navigational performance.

3.12 Global Positioning System (GPS)

3.12.1 GPS is a satellite-based radio navigation system, based on the World Geodetic System - 1984 (WGS-84) datum, which provides highly accurate position and velocity information.

3.12.2 Use of GPS for IFR operations is dependent on the US Department of Defense GPS Standard Positioning Service operating to its defined full operating capability.

4. COMMUNICATION SERVICES

4.1 Radio Frequencies

4.1.1 **General.** Air ground communications in Australian FIRs are conducted by radio telephony in the VHF, UHF and HF bands. Air-to-air communications are normally conducted in the VHF band. The requirements for carriage of radio communications systems are contained in GEN 1.5 [section 1](#). Frequencies are published in ERSA. VHF is the primary frequency band, with HF only being used when outside VHF coverage. Selected VHF frequencies are published in ERSA and are depicted on AIP Aeronautical Navigation Charts. The estimated coverage is shown on Airservices Australia Planning Chart Australia (PCA).

4.1.2 UHF is intended primarily for use with military aircraft. At some locations, re-transmit facilities, which permit UHF and VHF aircraft to copy VHF/UHF transmissions conducted with a common ATS unit, are installed.

4.1.3 **HF.** The appropriate HF frequency for an area of operations is shown on Planning Chart Australia (PCA). In TCTA and OCA, ATS may nominate the appropriate frequency to be used by aircraft. For those operations outside VHF coverage, where the maintenance of a continuous two-way communications watch with an airways operations unit is mandatory, the carriage of suitable HF frequencies is required.

Note 1: ATC will provide the relevant frequencies to IFR flights when transferring from VHF to HF communication, and to other flights on request.

Note 2: SELCAL is available to appropriately equipped aircraft. Frequencies for this service are listed in ERSA.

4.1.4 **Interpilot Air-to-Air Communication.** In accordance with regional agreements, 123.45 MHz is designated as the air-to-air VHF communications channel. Use of this channel will enable aircraft engaged in flights over remote and oceanic areas out of range of VHF ground stations and not in the vicinity of a non-controlled aerodrome depicted on an aeronautical chart to exchange necessary operational information and to facilitate the resolution of operational problems.

4.1.5 **SELCAL** is available to appropriately equipped aircraft. Frequencies for this service are listed in ERSA.

4.2 Certified Air/Ground Radio Service (CA/GRS)

4.2.1 A Certified Air/Ground Radio Service (CA/GRS) is an aerodrome-based radio information service, which may operate at non-controlled aerodromes. The service is a safety enhancement facility which provides pilots with operational information relevant to the particular aerodrome. The service is operated by or for the aerodrome operator to published hours, on the CTAF assigned to the particular aerodrome. It is not an Airservices or RAAF-provided air traffic service.

4.2.2 The CA/GRS does not provide any separation service.

4.2.3 The callsign of the service is the aerodrome location followed by 'Radio'; e.g. 'Ayers Rock Radio'. The radio operators of the service have been certified to meet a CASA standard of communication technique and aviation knowledge appropriate to the service being provided.

4.2.4 The CA/GRS is provided to all aircraft operating within the designated broadcast area for the specific location. Refer to ERSA for the location specific designated broadcast areas.

4.2.5 When a CA/GRS is operating, pilot procedures are unchanged from the standard non-controlled aerodrome operating and communication procedures. ERSA includes location specific information relating to procedures.

4.2.6 The operational information provided by a CA/GRS assists pilots in making informed operational decisions. Pilots retain authority and responsibility for the acceptance and use of the information provided.

4.2.7 Aircraft making the normal inbound or taxiing broadcast receive a responding broadcast from the CA/GRS operator, conveying the following information:

- a. Confirmation of the correct CTAF.
- b. Current, known, relevant traffic in the vicinity of the aerodrome and on the manoeuvring area of the aerodrome. Traffic information may include some or all of the following:
 - 1) aircraft type, callsign, position and intention; or
 - 2) where circuit flying is in operation, general advice on the number of aircraft in the circuit, and position in the circuit if relevant.

Note: This information is provided as an advisory to pilots in VMC and to assist pilots in arranging self-separation in IMC.

- c. Weather conditions and operational information for the aerodrome. The information which may be advised includes:
 - 1) runway favoured by wind or noise abatement;
 - 2) runway surface conditions;
 - 3) wind direction and speed;
 - 4) visibility and present weather;
 - 5) estimated cloud base;
 - 6) aerodrome surface temperature; and
 - 7) aerodrome QNH.

Note: This information will be provided by means of an Automatic Aerodrome Information Service (AAIS) broadcast on a discrete frequency (similar to ATIS) when the CA/GRS is operating or on request to the CA/GRS operator. Pilots should monitor the published AAIS frequency before making the taxiing or inbound

broadcast, and indicate that the AAIS information has been received when making the inbound or taxiing broadcast.

- d. Other operational information of a local nature, relevant to the safety of operations at the aerodrome.

4.2.8 The CA/GRS will provide emergency services call-out if requested by the pilot in an emergency or, if in the opinion of the operator, a call-out is warranted.

4.2.9 The weather information provided by the service is derived from approved measuring equipment, which meets BoM aeronautical precision standards. QNH provided by a CA/GRS or AAIS may be used to reduce landing, circling and alternate minima in accordance with FIHA ENR 1.5, [sub-section 5.3](#) (QNH sources).

4.2.10 The CA/GRS operator may act as a representative of an air operator (where formal agreement with the operator has been established) for the purposes of holding SARWATCH.

4.3 UNICOM

4.3.1 UNICOM (Universal Communications) is a non-ATS communications service provided to enhance the value of information normally available about a non-controlled aerodrome.

4.3.2 The primary function of the frequency used for UNICOM services where the UNICOM is the CTAF is to provide pilots with the means to make standard positional broadcasts when operating in the vicinity of an aerodrome. Participation in UNICOM services must not inhibit the transmission of standard positional broadcasts.

4.3.3 Participation in UNICOM services relates to the exchange of information concerning:

- a. fuel requirements;
- b. estimated times of arrival and departure;
- c. aerodrome information;
- d. maintenance and servicing of aircraft including the ordering of parts and materials urgently required;
- e. passenger requirements;
- f. unscheduled landings to be made by aircraft;
- g. general weather reports; and
- h. basic information on traffic.

4.3.4 This information is available to all aircraft during the times that the UNICOM is operating.

4.3.5 Weather reports, other than simple factual statements about the weather, may not be provided by UNICOM operators unless they hold an aviation weather observer qualification issued by the Bureau of Meteorology.

4.3.6 The UNICOM operator is solely responsible for the accuracy of any information passed to an aircraft, while the use of information obtained from a UNICOM is at the discretion of the aircraft captain.

4.3.7 Stations providing a UNICOM service are required to be licensed by the Australian Communications and Media Authority (ACMA). Detailed information regarding the licensing and use of equipment may be obtained by contacting the ACMA in the appropriate State or Territory capital city.

4.4 Aerodrome Frequency Response Unit

4.4.1 To assist pilots' awareness of inadvertent selection of an incorrect VHF frequency when operating into non-controlled aerodromes, a device known as an Aerodrome Frequency Response Unit (AFRU) may be installed. An AFRU will provide an automatic response when pilots transmit on the CTAF for the aerodrome at which it is installed.

4.4.2 The features of the AFRU are as follows:

- a. When the aerodrome traffic frequency has not been used for the past five minutes, the next transmission over two (2) seconds long will cause a voice identification to be transmitted in response, e.g., "GOULBURN CTAF".
- b. When the aerodrome traffic frequency has been used within the previous five minutes, a 300 millisecond tone will be generated after each transmission over two seconds long.

4.4.3 A series of three microphone clicks within a period of five seconds will also cause the AFRU to transmit a voice identification for the particular aerodrome.

4.4.4 In the event that the transmitter in the AFRU becomes jammed for a period of greater than one minute, the unit will automatically shutdown.

4.4.5 The operation of the AFRU provides additional safety enhancements by confirming the operation of the aircraft's transmitter and receiver, the volume setting, and that the pilot has selected the correct frequency for use at that aerodrome.

4.5 Aeronautical Fixed Telecommunication Network

4.5.1 The AFTN is established primarily for ATS unit intercommunication. However, subject to certain provisos, the AFTN may be used to transmit messages concerning flight safety, flight regularity, reservation and general operating agency aspects. Details are available from ATS units.

4.5.2 A matrix of the Australian AFTN circuitry is contained at [Appendix 1](#).

4.6 Special Broadcast Services

4.6.1 **ATIS** is a continuous transmission, on a discrete frequency or on the IDENT channel of a VOR or NDB, of the operational information. Details are in *GEN 3.3 Section 3.3* and frequencies in *ERSA*.

4.6.2 **VOLMET** broadcasts contain selected meteorological information on discrete frequencies. Details are in *GEN 3.5 section 7*, and frequencies in *ERSA*.

4.6.3 **AWIS** broadcasts actual weather conditions on navigation aids from AWS sites which use Bureau of Meteorology AWS equipment. Details are in *GEN 3.5, section 9*, and frequencies in *ERSA*.

4.7 Aeronautical Codes

4.7.1 Aeronautical codes, including location indicators for Australian aerodromes, are published in *ERSA* and *Airservices Australia AIP MAP (Charts)*.

5. RADIO TELEPHONY PROCEDURES

5.1 Introduction

5.1.1 The communication procedures, phraseologies and requirements contained in this section have been selected to harmonise with ICAO and international practices where applicable. Additional phrases to supplement where ICAO is silent have been included.

5.1.2 Primary reference documents on radio telephony are ICAO Doc 4444, Doc 9432, and Annex 10. ATS and pilots should refer to these documents to obtain additional information as necessary. Only procedures appropriate to Australia and commonly used phrases are contained in this section.

5.1.3 Use of standard phrases for radio telephony communication between aircraft and ground stations is essential to avoid misunderstanding the intent of messages and to reduce the time required for communication.

5.1.4 Where circumstances warrant, and no phraseology is available, clear and concise plain language should be used to indicate intentions.

5.1.5 Phraseologies contained in this section are generic and, although primarily reflecting a controlled airspace environment, pilots operating in Class G airspace should use these generic phrases unless specific Class G phrases are shown.

5.2 General

5.2.1 **Symbols and Parentheses.** Words in parentheses “()” indicate that specific information, such as a level, a place, or a time, etc., must be inserted to complete the phrase, or alternatively, that optional phrases may be used. Words in square parentheses “[]” indicate optional additional words or information that may be necessary in specific instances.

5.2.2 This paragraph from *Airservices Australia AIP* not applicable to ADF.

5.2.3 Phraseologies show the text of message components without callsigns. They are not intended to be exhaustive, and when circumstances differ, pilots, ATS and Air Defence personnel, and other ground personnel will be expected to use appropriate subsidiary phraseologies which should be clear, concise, and designed to avoid any possible confusion.

5.2.4 For convenience, the phraseologies are grouped according to types of air traffic service. However, users should be familiar with, and use, as necessary, phraseologies from groups other than those referring specifically to the type of air traffic service being provided. All phraseologies must be used in conjunction with callsigns (aircraft, ground vehicle, ATC or other) as appropriate.

5.2.5 Phraseologies for the movement of vehicles are not listed separately as the phraseology associated with the movement of aircraft is applicable. The exception is for taxi instructions, in which case the word "PROCEED" will be substituted for the word "TAXI" when ATC communicates with vehicles.

5.3 Transmission Format

5.3.1 When initiating a transmission to ATS, pilots will commence the transmission with the callsign of the unit being addressed followed by the aircraft callsign.

5.3.2 For aircraft in the Super or Heavy wake turbulence categories, the word 'SUPER' or 'HEAVY' respectively must be included immediately after the aircraft callsign in the initial radiotelephony contact between such aircraft and each approach, departures, director, ground and tower controller.

5.3.3 The ATS unit will respond using the station's callsign followed by their callsign. In the absence of an instruction to "STAND BY", this response by the ATS unit is an invitation for the aircraft calling to pass their message.

Note: The use of the words "GO AHEAD" is no longer considered appropriate due to the possibility of misconstruing "GO AHEAD" as an authorisation for an aircraft to proceed.

5.3.4 A readback of an ATS message will be terminated with the aircraft's callsign.

5.4 Readback Requirements

5.4.1 Pilots must transmit a correct readback of ATC clearances, instructions and information which are transmitted by voice. For other than [Item a](#), only key elements of the following clearances, instructions or information must be readback ensuring sufficient detail is included to indicate compliance:

- a. an ATC route clearance in its entirety, and any amendments;
- Note: "Rest of clearance unchanged" is not required to be readback.*
- b. en route holding instructions;
- c. any route and runway-holding point specified in a taxi clearance;
- d. any clearances, conditional clearances or instructions to hold short of, enter, land on, line-up on, wait, takeoff from, cross, taxi or backtrack on, any runway or HLS;
- e. any approach clearance;
- f. assigned runway, or HLS;
- g. altimeter settings directed to specific aircraft, radio and radio navigation aid frequency instructions;

Note: An "expectation" of the runway to be used is not to be readback.

- h. SSR codes, data link logon addresses;
- i. level instructions (including 'VIA SID/STAR TO' when this is part of the instruction), direction of turn, heading and speed instructions.

5.4.2 The controller will listen to the readback to ascertain that the clearance or instruction has been correctly acknowledged and will take immediate action to correct any discrepancies revealed by the readback.

5.4.3 Reported level figures of an aircraft must be preceded by the words "FLIGHT LEVEL" when related to standard pressure and may be followed by the word "FEET" when related to QNH.

5.5 Conditional Clearances

5.5.1 In all cases, a conditional clearance will be given in the following order and consist of:

- a. identification (callsign);
- b. the condition (including position of the subject of the condition);
- c. the clearance; and
- d. brief reiteration of the condition.

5.6 Route Terminology

5.6.1 The phrase “FLIGHT PLANNED ROUTE” may be used to describe any route or portion thereof that is identical to that filed in the flight notification and sufficient routing details are given to definitely establish the aircraft on its route.

5.7 Amended Route or Level

5.7.1 When ATS provide an initial airways clearance that is not in accordance with the details currently held by ATC system, ATS will prefix the route and/or level details with the word “AMENDED”.

5.7.2 When an issued airways clearance needs to be changed ATS will prefix the new route and/or level details with the word “RECLEARED”. The level will be stated in all clearance changes regardless of whether a change to the cleared level is made or not.

5.7.3 The prefixes “AMENDED” and “RECLEARED” will not be used:

- a. for SID or STAR clearances; or
- b. during normal progressive climb/descent instructions.

5.8 Language

5.8.1 English language must be used for all air-ground RTF communications within Australian FIRs unless use of an alternative language has been arranged with ATS prior to any specific flight.

5.9 Phonetic Alphabet

5.9.1 When proper names, service abbreviations and words of which the spelling is doubtful are spelled out in radiotelephony, the alphabet shall be used as follows:

Letter	Word	Pronunciation	Letter	Word	Pronunciation
A	ALFA	AL fah	N	NOVEMBER	no VEM ber
B	BRAVO	BRAH voh	O	OSCAR	OSS cah
C	CHARLIE	CHAR lee or SHAR lee	P	PAPA	pah PAH
D	DELTA	DELL tah	Q	QUEBEC	keh BECK
E	ECHO	ECK ho	R	ROMEO	ROW me oh
F	FOXTROT	FOKS trot	S	SIERRA	see AIR rah
G	GOLF	GOLF	T	TANGO	TANG go
H	HOTEL	ho TELL	U	UNIFORM	YOU nee form or OO nee form
I	INDIA	IN dee A	V	VICTOR	VIK tah
J	JULIETT	JEW lee ETT	W	WHISKEY	WISS key
K	KILO	KEY loh	X	X-RAY	ECKS ray
L	LIMA	LEE mah	Y	YANKEE	YANG key
M	MIKE	MIKE	Z	ZULU	ZOO loo

Note: For pronunciation, syllables to be emphasised are in all capitals.

5.10 Pronunciation of numbers

5.10.1 Radio telephony pronunciation of numbers shall be as follows:

0	ZE-RO	5	FIFE	Decimal	DAY-SEE-MAL
1	WUN	6	SIX	Hundred	HUN-dred
2	TOO	7	SEV-en	Thousand	TOU-SAND
3	TREE	8	AIT		
4	FOW-er	9	NIN-er		

Note: The syllables printed in capital letters in the above list are to be stressed.

5.11 Transmission of Numbers

Note: See section 4.10 for pronunciation.

5.11.1 All numbers, other than those described in 5.11.2 - 5.11.8, should be transmitted by pronouncing each digit separately.

Element	Transmission format
<i>Heading</i>	
100 degrees	HEADING ONE ZERO ZERO
080 degrees	HEADING ZERO EIGHT ZERO
<i>Wind direction and speed</i>	
200 degrees 70 knots	WIND TWO ZERO ZERO DEGREES SEVEN ZERO KNOTS
160 degrees 18 knots gusting 30 knots	WIND ONE SIX ZERO DEGREES ONE EIGHT KNOTS GUSTING THREE ZERO KNOTS
<i>Runway</i>	
27	RUNWAY TWO SEVEN
30	RUNWAY THREE ZERO

5.11.2 Flight levels should be transmitted by pronouncing each digit separately except for the case of flight levels in whole hundreds, which should be transmitted by pronouncing the digit of the whole hundred followed by the word HUNDRED.

Flight levels	Transmission format
FL 180	FLIGHT LEVEL ONE EIGHT ZERO
FL 200	FLIGHT LEVEL TWO HUNDRED

5.11.3 The altimeter setting should be transmitted by pronouncing each digit separately except for the case of a setting of 1,000HPA which must be transmitted as ONE THOUSAND.

Altimeter setting	Transmission format
1,010	QNH ONE ZERO ONE ZERO
1,000	QNH ONE THOUSAND
993	QNH NINE NINE THREE

5.11.4 All numbers used in the transmission of transponder codes should be transmitted by pronouncing each digit separately except that transponder code containing whole thousands should be transmitted by pronouncing the digit in the number of thousands followed by the word THOUSAND.

Transponder codes	Transmission format
2,400	SQUAWK TWO FOUR ZERO ZERO
1,000	SQUAWK ONE THOUSAND
2,000	SQUAWK TWO THOUSAND

5.11.5 All numbers used in the transmission of altitude, cloud height, visibility and RVR, which contain whole hundreds and whole thousands, should be transmitted by pronouncing each digit in the number of hundreds or thousands followed by the word HUNDRED or THOUSAND as appropriate. Combinations of thousands and whole hundreds should be transmitted by pronouncing each digit in the number of thousands followed by the word THOUSAND followed by the number of hundreds followed by the word HUNDRED.

Element	Transmission format
<i>Altitude</i>	
800	EIGHT HUNDRED
3,400	THREE THOUSAND FOUR HUNDRED
12,000	ONE TWO THOUSAND
<i>Cloud height</i>	
2,200	TWO THOUSAND TWO HUNDRED
4,300	FOUR THOUSAND THREE HUNDRED
<i>Visibility</i>	
1,000	VISIBILITY ONE THOUSAND
700	VISIBILITY SEVEN HUNDRED
<i>RVR</i>	
600	RVR SIX HUNDRED
1,700	RVR ONE THOUSAND SEVEN HUNDRED

5.11.6 When providing information regarding relative bearing in terms of the 12-hour clock, the information should be transmitted by pronouncing the double digits as TEN, ELEVEN, or TWELVE [O'CLOCK].

5.11.7 Numbers containing a decimal point should be transmitted with the decimal point in appropriate sequence being indicated by the word DECIMAL.

Number	Transmitted as
100.3	ONE ZERO ZERO DECIMAL THREE
38,143.9	THREE EIGHT ONE FOUR THREE DECIMAL NINE
29.93 (<i>inches QNH</i>)	QNH TWO NINE DECIMAL NINE THREE
M0.84 (Mach)	MACH DECIMAL EIGHT FOUR

5.11.8 When transmitting time, only the minutes of the hour should normally be required. Each digit should be pronounced separately. However, the hour should be included when any possibility of confusion is likely to result.

Element	Transmitted as
<i>Time</i>	
0920	TIME TWO ZERO or ZERO NINE TWO ZERO
1643	TIME FOUR THREE or ONE SIX FOUR THREE
<i>Accurate time check (nearest half minute)</i>	
0945 and 25 seconds	TIME FOUR FIVE AND A HALF or ZERO NINE FOUR FIVE AND A HALF

5.12 Ground Station Callsigns

5.12.1 **ATS Callsigns** - ATS units are identified by the name of the location followed by the service available as follows:

En route area control, SIS and FIS.	CENTRE
Approach control where provided as a separate function.	APPROACH
Departure control where provided as a separate function.	DEPARTURES
Surveillance control providing vectors onto final approach.	FINAL/DIRECTOR
Aerodrome control or aerodrome and approach control where these services are provided from an aerodrome control tower, e.g. Coffs Harbour.	TOWER
Surface movement control.	GROUND
Clearance delivery to departing aircraft.	DELIVERY
Flight Information Service.	FLIGHTWATCH
Aerodrome or Surveillance Flight Information Service.	INFORMATION
HF	RADIO

5.12.2 The name of the location or the service may be omitted provided that satisfactory communication has been established and no risk of misidentification exists.

5.13 Aircraft Callsigns

5.13.1 Improper use of callsigns can result in pilots executing a clearance intended for another aircraft. Callsigns should never be abbreviated on an initial contact or at any time when other aircraft callsigns have similar numbers/sounds or identical letters/numbers, e.g. CHARLIE WHISKEY ZULU - WHISKEY CHARLIE ZULU.

5.13.2 Pilots must be certain that aircraft identification is complete and clearly identified before taking action on an ATC clearance. ATS will use full or abbreviated callsigns in accordance with [section 5.19](#). The pilot may only use an abbreviated callsign when initiated by ATS. When aware of similar/identical callsigns, ATS will take action to minimise errors by:

- a. emphasising certain numbers/letters,
- b. repeating the entire callsign, e.g. QANTAS451 QANTAS451, or
- c. repeating the prefix, e.g. QANTAS451 QANTAS, or
- d. asking pilots to use a different callsign, either temporarily or for the duration of the flight.

5.13.2.1 Pilots should use the phrase “VERIFY CLEARANCE FOR (complete callsign)” if doubt exists concerning proper identity.

5.13.3 **ADF** - Military aircraft callsigns are not to be abbreviated.

5.13.4 **ADF** - Approved military callsigns are detailed in MATS.

5.14 Flight Number Callsigns - Using Group Form

5.14.1 Within Australian airspace “group form” is the preferred means of transmitting callsign/flight number. Group form should also be used with military and other aircraft using a rootword callsign with numeric suffix.

5.14.2 Group form is the grouping of numbers into pairs, or where a number ending in “00” is spoken in hundreds (refer [section 5.15](#)). For three digit numbers, the second and third numbers are grouped. Examples are as follows:

QLINK 122	“QLINK ONE TWENTY TWO”
QANTAS 1220	“QANTAS TWELVE TWENTY”
CAR 21	“CAR TWENTY ONE”
CLASSIC 12	“CLASSIC TWELVE”
VIRGIN 702	“VIRGIN SEVEN ZERO TWO”
BIRDOG 021	“BIRDOG ZERO TWENTY ONE”

5.14.3 Pilots and ATS should be aware that the preference to use “group form” does not invalidate any transmissions made in conventional formats. However, to retain the integrity in the communication between ATS and operators, the identification format used should be consistent.

5.14.4 A pilot not using “group form” in establishing communication, but subsequently addressed by ATS in this format, should adopt the use of group form” for the remainder of the flight in Australian airspace.

5.14.5 There is no additional abbreviated form when using Flight Number callsigns. The airline designator and all digits of the callsign, including leading zeros, must be pronounced.

5.14.6 **ADF** - Formations should use a formation callsign available for their operating squadron or unit as detailed in MATS. When a formation splits, individual aircraft callsigns should contain the initial formation callsign followed by a number representing their mission/task number (if applicable) and relative position in the formation e.g. formation callsign CANN contains individual elements CANN11, CANN12, CANN13, etc. Aircraft split from a formation are not required to use group form radio telephony e.g. CANN11 would be pronounced “CANNON ONE ONE”.

5.15 Selection of Aircraft Identification Numbers and Suffixes

5.15.1 When selecting an aircraft identification number or callsign suffix, operators should avoid using numbers that correlate with:

- ending in “zero or “five”, to avoid confusion with headings;
- potential level utilisation (e.g. 3000, 500, 350 etc.);
- emergency codes (e.g. 7600, 7700 etc.); and
- numerical aircraft types (e.g. 767, 330 etc.).

5.15.2 Flight numbers and callsign suffix numbers should be limited to 2 or 3 characters and take into account flight numbers already in use by the operator and other agencies in the intended control environment, operational area or nearby.

5.15.3 Operators with approval to use a two-letter designator (e.g. AN) must use a numerical suffix of at least 2 numbers.

5.16 Ground Vehicles

5.16.1 Ground vehicles shall be identified by the type of vehicle; e.g., car, truck, tractor, tug, etc., or an ATS approved format, followed by the assigned vehicle number spoken in group form, e.g.:

TRUCK 12 “TRUCK TWELVE”
CAR 23 “CAR TWENTY THREE”.

5.17 Interchange and Leased Aircraft

5.17.1 This section from Airservices Australia AIP not applicable to ADF.

5.18 Unmanned Aerial Vehicles

5.18.1 Unmanned Aerial Vehicles (UAV) should select identification based on the aircraft manufacturer or model using a maximum of three syllables. Numbers may be added. UAV flight plan identification is detailed in ENR 1.10 Appendix 2

5.18.2 Communications on any frequency must use the prefix "UNMANNED" before the callsign. When the UAV operation is conducted in controlled airspace ATC may vary this requirement after initial contact.

5.19 Callsigns - Full and Abbreviated Formats

5.19.1 When establishing two-way communications and for subsequent communications on any frequency, Australian registered aircraft on domestic flights (i.e. within Australian FIR) must use one of the following callsigns:

- a. for VH-registered aircraft, the last 3 characters of the registration marking (e.g. VH-TQK "TANGO QUEBEC KILO"); or
- b. the approved telephony designator of the aircraft operating agency, followed by the last 3 characters of a VH registration marking (e.g. "QLINK TANGO QUEBEC KILO"); or
- c. the approved telephony designator of the aircraft operating agency, followed by the flight identification (e.g. "VELOCITY EIGHT FIFTY SIX DELTA"); or
- d. for recreation-category aircraft, the aircraft type followed by the last 4 characters of the aircraft's registration number (e.g. "JABIRU THIRTEEN FORTY SIX"); or
- e. for certain special task operations - see paragraph 5.21

5.19.2 When establishing two-way communications on any frequency, Australian registered aircraft on international flights and foreign registered aircraft must use one of the following callsigns:

- a. the characters corresponding to the registration marking of the aircraft (e.g. N35826 "NOVEMBER THREE FIFTY EIGHT TWENTY SIX"); or
- b. the approved telephony designator of the aircraft operating agency, followed by the last 4 characters of the registration marking of the aircraft (e.g. "UNITED FIFTY EIGHT TWENTY SIX"); or VH-TQK "VICTOR HOTEL TANGO QUEBEC KILO"); or
- c. the approved telephony designator of the aircraft operating agency, followed by the flight identification (e.g. "SPEEDBIRD FIFTY FIVE").

Note: The name of the aircraft manufacturer or aircraft model may be used as a radiotelephony prefix to the callsign type mentioned in sub-para 4.19.1a. and 4.19.2a.

5.19.3 After establishing two-way communications, ATS may initiate abbreviated callsigns for the type stated in 5.19.2a. and 5.19.2b. These callsigns may be abbreviated to:

- a. the first character of the registration and at least the last 2 characters of the registration marking (e.g. N35826 "NOVEMBER EIGHT TWENTY SIX") or VH-TQK "VICTOR QUEBEC KILO");
- b. the telephony designator of the aircraft operating agency, followed by at least the last 2 characters of the registration marking (e.g. "UNITED TWENTY SIX").

Note: For flight planning, all callsigns are limited to 7 characters.

5.19.4 In addition to the requirements of 4.19.1 to 4.19.3, the prefix "HELICOPTER" must be used by rotary wing aircraft when first establishing two way communications on any frequency (e.g. VH-WSO "HELICOPTER WHISKEY SIERRA OSCAR").

5.19.5 Civil formation flights of Australian registered aircraft may use the suffix "FORMATION" after one of the following callsigns:

- a. the registration of the formation leader e.g. "ALPHA BRAVO CHARLIE FORMATION"; or
- b. the approved telephony designator of the formation leader, with or without an alpha or numeric, e.g. "JETSPEED FORMATION" or "JETSPEED ONE FORMATION" or "JETSPEED BRAVO FORMATION".

5.19.6 **ADF** - When two or more military aircraft (single or formation) of a different mission/operation join in formation, the lead aircraft may append COMBINE to their callsign to simplify communication. The lead will advise ATC of the composition of the new formation and the new operating callsign; e.g. "WARLOCK22 and MAGPIE12 ADOPTING CALLSIGN WARLOCK22 COMBINE, CLOSE FORMATION".

Note: This does not preclude the use of two-word formation callsigns if desired; e.g. "HIPSHOT HOODOO".

5.20 Registration of Radiotelephony Designators

5.20.1 This section from Airservices Australia AIP not applicable to ADF.

5.21 Callsigns - Special Task Operations

5.21.1 Aircraft engaged in special task operations, and with the agreement of ATS, may use a callsign indicative of the nature of the task with a numerical suffix (if applicable), (see [paragraph 5.15](#)), e.g.

Type of Operation	Radio Telephony Designator (Callsign)	Flight Plan Designator
Ambulance	AMBULANCE	AM
Coordination of Firebombing Aircraft	BIRDOG	BDOG
Fire Bombing	BOMBER	BMBR
Powerline and pipeline survey and construction	ENERGY	ENRG
Federal Police	FEDPOL	FPL
Federal Police (Priority)	FEDPOL RED	FPLR
Night-time NVIS fire fighting operations	FIREAIR	FYRA
General Fire Support Tasks (light rotary)	FIREBIRD	FBIR
Remote Sensing Fire Operations	FIRESKAN	FSCN
Fire Intelligence Gathering	FIRESPTTR	SPTR
General Fire Support Tasks (medium rotary)	HELITAK	HLTK
Gliding operations	GLIDER	GLDR
Lifesaver Operations	LIFESAVER	LIFE
Validation of instrument procedures	NAVCHECK	NVCK
Media Operations	MEDIA	MDIA
Validation of Instrument Procedures	NAVCHECK	NVCK
Parks and Wildlife Service	PARKAIR	PKAR
Police	POLAIR	POL
Police (Priority)	POLAIR RED	POLR
Aerial Survey (mapping, geographical, etc)	SURVEY	SVY
Rescue Mission	RESCUE	RSCU
Aerial Survey	SURVEY	SVY

GEN 3.4

- 5.21.2 Callsign suffix numbers are allocated as follows:
NSW/ACT - commencing with 2 (e.g. 201, 214, 223);
VIC - commencing with 3;
QLD - commencing with 4;
SA - commencing with 5;
WA - commencing with 6;
TAS - commencing with 7;
NT - commencing with 8;
Defence - commencing with 9; and
Gliding operations - alphanumeric characters.

5.21.3 Use of these numbers will ensure aircraft transiting state borders utilising the same callsign prefix do not duplicate an existing callsign suffix number or flight plan.

6. PHRASEOLOGIES

6.1 Standard Words and Phrases

6.1.1 The following words and phrases are to be used in radio telephony communications, as appropriate, and have the meaning given:

Word/Phrase	Meaning
ACKNOWLEDGE	Let me know that you have received and understood this message.
AFFIRM	Yes.
APPROVED	Permission for proposed action granted.
BREAK	I hereby indicate the separation between portions of the message (to be used where there is no clear distinction between the text and other portions of the message).
BREAK BREAK	I hereby indicate separation between messages transmitted to different aircraft in a very busy environment.
CANCEL	Annul the previously transmitted clearance.
CHECK	Examine a system or procedure (no answer is normally expected).
CLEARED	Authorised to proceed under the conditions specified.
CONFIRM	I request verification of: (clearance, instruction, action, information).
CONTACT	Establish communication with...
CORRECT	True <i>or</i> Accurate.
CORRECTION	An error has been made in this transmission (or message indicated) the correct version is...
DISREGARD	Ignore.
HOW DO YOU READ	What is the readability of my transmission? The readability scale is: 1. Unreadable 2. Readable now and then 3. Readable but with difficulty 4. Readable 5. Perfectly readable.
I SAY AGAIN	I repeat for clarity or emphasis.
MAYDAY	My aircraft and its occupants are threatened by grave and imminent danger and/ or I require immediate assistance.
MAINTAIN	Continue in accordance with the condition(s) specified or in its literal sense, e.g. "Maintain VFR".

Word/Phrase	Meaning
MONITOR	Listen out on (frequency).
NEGATIVE	No or Permission is not granted or That is not correct or Not capable.
OUT	This exchange of transmissions is ended and I expect no response from you (<i>not normally used in VHF or satellite communication</i>).
OVER	My transmission is ended and I expect no response from you (<i>not normally used in VHF or satellite communication</i>).
PAN PAN	I have an urgent message to transmit concerning the safety of my aircraft or other vehicle or of some person on board or within sight but I do not require immediate assistance.
READBACK	Repeat all, or the specified part, of this message back to me exactly as received.
RECLEARED	A change has been made to your last clearance and this new clearance supersedes your previous clearance or part thereof.
REPORT	Pass me the following information.
REQUEST	I should like to know or I wish to obtain.
ROGER	I have received all of your last transmission (<i>under NO circumstances to be used in reply to a question requiring READBACK or a direct answer in the affirmative or negative</i>).
SAY AGAIN	Repeat all or the following part of your last transmission.
SPEAK SLOWER	Reduce your rate of speech.
STANDBY	Wait and I will call you.
UNABLE	I cannot comply with your request, instruction or clearance (<i>normally followed by a reason</i>).
VERIFY	Check and confirm with originator.
WILCO	I understand your message and will comply with it.
WORDS TWICE	As a request: Communication is difficult. Please send every word or group of words twice. As information: Since communication is difficult every word or group of words in this message will be sent twice.

6.2 Emergency

Circumstances	Phraseologies * Denotes pilot transmission
<p>1. Distress message</p>	<p>a. *MAYDAY [MAYDAY, MAYDAY] followed as necessary by:</p> <ul style="list-style-type: none"> (i) (station addressed) (ii) (aircraft identification) (iii) (nature of distress condition e.g. FUEL or EMERGENCY DESCENT) (iv) (intentions) (v) (position, level and heading) (vi) (any other useful information)
<p>2. Acknowledgement of distress message</p> <p>ATC acknowledgement of MAYDAY call</p> <p>ATC acknowledgement of MAYDAY on frequency transfer</p> <p>Imposition of radio silence</p> <p>ATC broadcast for emergency descent traffic</p> <p>Cancellation of distress condition</p> <p>Termination of distress and radio silence</p>	<p>a. ROGER MAYDAY</p> <p>b. MAYDAY [(type of emergency)] ACKNOWLEDGED</p> <p>c. STOP TRANSMITTING. MAYDAY</p> <p>d. EMERGENCY DESCENT AT (significant point or location) ALL AIRCRAFT BELOW (level) WITHIN (distance) OF (significant point or navigation aid) [LEAVE IMMEDIATELY] [(specific instructions as to direction, heading or track, etc)]</p> <p>e. *CANCEL DISTRESS (information)</p> <p>f. DISTRESS TRAFFIC ENDED</p>
<p>3. Urgency message</p> <p>ATC acknowledgement of PAN call</p> <p>ATC acknowledgement of PAN on frequency transfer</p>	<p>a. *PAN PAN [PAN PAN, PAN PAN] followed as necessary by:</p> <ul style="list-style-type: none"> (i) (station addressed) (ii) (aircraft identification) (iii) (nature of urgency condition e.g. MEDICAL PRIORITY REQUIRED or WEATHER DEVIATION REQUIRED) (iv) (intentions) (v) (position, level and heading) (vi) (any other useful information) <p>b. ROGER PAN</p> <p>c. PAN [(type of emergency)] ACKNOWLEDGED</p>

**6.3 Traffic Alert and Collision Avoidance System (TCAS),
Safety Alerts and Avoiding Action and Wind Shear Escape**

<i>Circumstances</i>	<i>Phraseologies</i> * Denotes pilot transmission
<p>1. Level Changes, Reports/Rates</p> <p>a flight crew starts to deviate from any ATC clearance or instruction to comply with an ACAS resolution advisory (RA) (Pilot and controller interchange)</p> <p>after the response to an ACAS RA is completed and a return to the ATC clearance or instruction is initiated (Pilot and controller interchange)</p> <p>after the response to an ACAS RA is completed and the assigned ATC clearance or instruction has been resumed (Pilot and controller interchange)</p> <p>after an ATC clearance or instruction contradictory to the ACAS RA is received, the flight crew will follow the RA and inform ATC directly (Pilot and controller interchange)</p>	<p>a. *TCAS RA</p> <p>b. ROGER</p> <p>c. *CLEAR OF CONFLICT RETURNING TO <i>(assigned clearance)</i></p> <p>d. ROGER <i>(or alternative instructions)</i></p> <p>e. *CLEAR OF CONFLICT <i>(assigned clearance)</i> RESUMED</p> <p>f. ROGER <i>(or alternative instructions)</i></p> <p>g. *UNABLE, TCAS RA</p> <p>h. ROGER</p> <p><i>Note: Pilots are required to comply with any TCAS RA manoeuvre irrespective of ATC traffic advisories or instructions.</i></p>
<p>2. Safety Alert and Avoiding Action</p> <p>low altitude warning</p> <p>terrain alert</p> <p>traffic alert</p> <p>unauthorised entry into active Restricted Area or Military Operating Area has occurred or is imminent</p> <p>when unauthorised deviation into Restricted Area or Military Operating Area is unavoidable</p>	<p>a. SAFETY ALERT, <i>followed as necessary by:</i></p> <p>(i) LOW ALTITUDE WARNING, CHECK YOUR ALTITUDE IMMEDIATELY, QNH IS <i>(number)</i> [<i>(units)</i>], [THE MINIMUM SAFE ALTITUDE IS <i>(altitude)</i>].</p> <p>(ii) TERRAIN, CHECK YOUR ALTITUDE IMMEDIATELY <i>(suggested pilot action, if possible)</i>.</p> <p>(iii) TRAFFIC <i>(number)</i> MILES OPPOSITE DIRECTION/ CROSSING LEFT TO RIGHT/ RIGHT TO LEFT <i>(level information)</i>.</p> <p>(iv) RESTRICTED AIRSPACE <i>(or MILITARY OPERATING AREA)</i> ACTIVE. [SUGGEST] TURN LEFT/RIGHT IMMEDIATELY HEADING <i>(three digits)</i></p> <p>(v) RESTRICTED AIRSPACE <i>(or MILITARY OPERATING AREA)</i> ACTIVE. [SUGGEST] CLIMB/ DESCEND IMMEDIATELY TO <i>(level)</i></p> <p>(vi) UNABLE TO ISSUE CLEARANCE. PROCEED AT YOUR OWN RISK, SQUAWK 7700.</p>

Circumstances	Phraseologies * Denotes pilot transmission
avoiding action	<p>b. AVOIDING ACTION, <i>followed as necessary</i> by:</p> <p>(i) [SUGGEST] TURN LEFT/RIGHT IMMEDIATELY HEADING (<i>three digits</i>), TRAFFIC [LEFT/RIGHT] (<i>number</i>) O'CLOCK (<i>distance</i>) MILES, OPPOSITE DIRECTION/CROSSING LEFT TO RIGHT/ RIGHT TO LEFT (<i>level information</i>).</p> <p>(ii) [SUGGEST] CLIMB/DESCEND IMMEDIATELY TO (<i>level</i>) TRAFFIC [LEFT/RIGHT] (<i>number</i>) O'CLOCK (<i>distance</i>) MILES OPPOSITE DIRECTION/CROSSING LEFT TO RIGHT/RIGHT TO LEFT (<i>level information</i>).</p> <p><i>Note 1: Where clock codes are used to provide the relative bearing, the prefix left/right is optional.</i></p> <p><i>Note 2: In high density traffic scenarios it may be impractical for ATC to use the full phraseologies for safety alerts and avoiding action. ATC will provide information that conveys the immediacy of the situation and relevant instructions to allow pilots the best opportunity to avoid a collision.</i></p> <p><i>Note 3: Pilots are required to comply with any TCAS RA manoeuvre irrespective of ATC traffic advisories or instructions.</i></p>
<p>3. Wind Shear Escape Manoeuvre</p> <p>ATC acknowledge</p> <p>Mutual traffic information</p> <p>Wind Shear Escape Manoeuvre complete</p> <p>ATC acknowledgement</p> <p>Wind shear prevents compliance with an ATC clearance or instruction</p>	<p>a. *WIND SHEAR ESCAPE</p> <p>b. ROGER [SAFETY ALERT] [TRAFFIC (<i>distance</i>) MILES (<i>relevant information</i>)]</p> <p>c. [SAFETY ALERT] TRAFFIC (<i>distance</i>) MILES (<i>relevant information</i>) EXPERIENCING WIND SHEAR</p> <p>d. *CLEAR OF WIND SHEAR RETURNING TO (<i>assigned clearance, instruction and/or procedure etc</i>)</p> <p>e. ROGER [<i>alternative instructions</i>]</p> <p>f. *UNABLE, WIND SHEAR ESCAPE</p>
<p>4. Wind Shear or Microburst Alert</p>	<p>a. RUNWAY (<i>number</i>) ARRIVAL (<i>or</i>) DEPARTURE) WIND SHEAR (<i>or</i>) MICROBURST) ALERT (<i>windspeed</i>) KNOT GAIN (<i>or</i>) LOSS (<i>location</i>)</p>

6.4 Status of Restricted Areas and Military Operating Areas

<i>Circumstances</i>	<i>Phraseologies</i> * Denotes pilot transmission
When active:	a. RESTRICTED AREA (or MILITARY OPERATING AREA) (number) ACTIVE, followed as necessary by: <ul style="list-style-type: none"> (i) CLEARANCE REQUIRED (ii) AVAILABLE FOR TRANSIT (iii) AVAILABLE UNTIL TIME (time) (iv) CLEARANCE NOT AVAILABLE (v) ...(other qualification as appropriate)
Released to civil ATC	b. RESTRICTED AREA (or MILITARY OPERATING AREA) (number) RELEASED TO (civil ATS unit), followed as necessary by: <ul style="list-style-type: none"> (i) CLEARANCE NOT AVAILABLE (ii) (clearance) (iii) APPROVED TO OPERATE IN RESTRICTED AREA (or MILITARY OPERATING AREA) (number) [CLASS (airspace category) PROCEDURES APPLY]

6.5 SARWATCH

6.5.1 SARTIME

<i>Circumstances</i>	<i>Phraseologies</i> * Denotes pilot transmission
1. SARTIME nomination	a. *SARTIME details b. STANDBY or (callsign) c. *SARTIME FOR DEPARTURE (or ARRIVAL) [location] (time)
2. SARTIME cancellation	a. *SARTIME details b. STAND BY or (callsign) c. *(position/location) CANCEL SARTIME
3. SARTIME amendment	a. *SARTIME details b. STAND BY or (callsign) c. As required, including specific phrases nominated above, if applicable

6.5.2 SARWATCH Other Than SARTIME

Circumstances	Phraseologies * Denotes pilot transmission
<p>1. Departure Reports to initiate a SARWATCH when communication on the ground is not available.</p>	<p>a. *AIRBORNE (<i>location</i>)</p>
<p>2. Flight & Arrival Reports</p> <p>form of acknowledgment to CANCEL SARWATCH</p> <p>when the ATS unit accepting the arrival report is other than the unit addressed</p>	<p>a. * (<i>position</i>) CANCEL SARWATCH [ADVISE (<i>unit</i>) if appropriate]</p> <p>b. SARWATCH CANCELLED [WILCO (<i>unit</i>)]</p> <p>c. [<i>location</i>] SARWATCH TERMINATED</p> <p>d. ROGER (<i>identity of unit acknowledging</i>)</p>

6.6 General Phrases

Circumstances	Phraseologies * Denotes pilot transmission
<p>1. Description of levels (subsequently referred to as “<i>level</i>”)</p>	<p>a. FLIGHT LEVEL (<i>number</i>) or</p> <p>b. (<i>number</i>) FEET</p>
<p>2. Level Instructions</p> <p>when there is an expectation that the aircraft will maintain the level or to eliminate confusion, the instruction “AND MAINTAIN” shall be included</p> <p>when rate is required to be in accordance with “STANDARD RATE” specifications</p> <p>when advising expectation of a level restriction</p>	<p>a. CLIMB (or DESCEND) followed as necessary by:</p> <ul style="list-style-type: none"> (i) TO (<i>level</i>) (ii) TO AND MAINTAIN (<i>level</i>) (iii) TO REACH (<i>level</i>) AT (or BY) (<i>time or significant point</i>) (iv) TO (<i>level</i>) REPORT LEAVING (or REACHING or PASSING or APPROACHING) (<i>level</i>) (v) AT (<i>number</i>) FEET PER MINUTE [MINIMUM (or MAXIMUM)] (vi) AT STANDARD RATE <p>b. EXPECT A RESTRICTION TO REACH (<i>level</i>) BY (<i>time or position</i>) followed as necessary by (a)</p> <p>c. STEP CLIMB (or DESCENT) (<i>aircraft identification</i>) ABOVE (or BENEATH) YOU</p> <p>d. REQUEST LEVEL CHANGE FROM (<i>name of unit</i>) AT (<i>time or significant point</i>)</p> <p>e. STOP CLIMB (or DESCENT) AT (<i>level</i>)</p> <p>f. CONTINUE CLIMB (or DESCENT) TO [AND MAINTAIN] (<i>level</i>)</p>

Circumstances	Phraseologies * Denotes pilot transmission
<p>pilot requesting a change of level</p> <p>to require action at a specific time or place</p> <p>to require action when convenient</p> <p>when a pilot is unable to comply with a clearance or instruction</p> <p>when a descent clearance is issued in relation to the DME (or GNSS) steps</p> <p>when a pilot is assigned and required to maintain separation with a sighted aircraft</p> <p>ATC requesting confirmation of equipment, capability or approval e.g. RVSM, ADS-B, PRM.</p> <p>Pilot report of equipment, capability or approval status</p> <p>Pilot of an IFR flight requests to climb/descend VFR</p> <p>IFR separation is available for part of the climb/descent</p>	<p>g. EXPEDITE CLIMB (or DESCENT) [UNTIL PASSING (level)]</p> <p>h. EXPECT CLIMB (or DESCENT) AT (time or location)</p> <p>i. * REQUEST CLIMB (or DESCENT) [AT (time or location)] [TO (level)]</p> <p>j. IMMEDIATELY</p> <p>k. AFTER PASSING (significant point)</p> <p>l. AT (time or significant point)</p> <p>m. WHEN READY (instruction)</p> <p>n. *UNABLE TO COMPLY</p> <p>o. DESCEND TO (level) NOT BELOW DME (or GNSS) STEPS</p> <p>p. FOLLOW (or MAINTAIN OWN SEPARATION WITH [AND PASS BEHIND]) (aircraft type or identification) [instructions or restriction]</p> <p>q. *CONFIRM (equipment, capability or approval) APPROVED (or EQUIPPED)</p> <p>r. *AFFIRM (or NEGATIVE) (equipment, capability or approval) (reason if applicable)</p> <p>s. * REQUEST VFR CLIMB (or DESCENT) [TO (level)]</p> <p>t. *CLIMB (or DESCEND) VFR to (level)</p> <p>u. CLIMB (or DESCEND) [TO (assigned level)] followed as necessary by:</p> <p style="padding-left: 40px;">(1) CLIMB (or DESCEND) VFR BETWEEN (level) AND (level)</p> <p style="padding-left: 40px;">(2) CLIMB (or DESCEND) VFR BELOW (or ABOVE) (level)</p>
<p>3. NVIS Operations</p> <p>ADF - Military pilots who have flight planned for operations or request to operate below LSALT in IMC or in VMC at night:</p> <p>ADF - Request to operate below LSALT in IMC or VMC at night without NVIS</p> <p>ADF - Request to operate below LSALT in VMC at night with NVIS</p> <p>ADF - When assigning levels to military pilots for operations below LSALT in IMC or VMC at night</p>	<p>a. *REQUEST (level) MILITARY TERRAIN CLEARANCE</p> <p>b. *REQUEST [NOT ABOVE] (level) NVIS</p> <p>c. Climb (or DESCEND) TO (or OPERATE NOT ABOVE) (level) MILITARY TERRAIN CLEARANCE / NVIS</p>

Circumstances	Phraseologies * Denotes pilot transmission
When climbing to regain LSALT/MSA other than in accordance with assigned airways clearance.	d. *CLIMBING TO (<i>level</i>), (<i>reason e.g. NVG failure or inadvertent IMC</i>)
4. Maintenance of Specified Levels <i>Note: The term "MAINTAIN" must not to be used in lieu of "DESCEND" or "CLIMB" when instructing an aircraft to change level</i>	a. MAINTAIN (<i>level</i>) [TO (<i>significant point</i>)] [<i>condition</i>]
5. Use of Block Levels established in the level range cancelling block level clearance	a. *REQUEST BLOCK LEVEL (<i>level</i>) TO (<i>level</i>) b. CLIMB (<i>or DESCEND</i>) TO AND MAINTAIN BLOCK (<i>level</i>) TO (<i>level</i>) c. MAINTAIN BLOCK (<i>level</i>) TO (<i>level</i>) d. CANCEL BLOCK CLEARANCE. CLIMB (<i>or DESCEND</i>) TO AND MAINTAIN (<i>level</i>)
6. Pilots without NVIS requesting operations below the published LSALT at night or in IMC.	a. REQUEST (<i>DESCEND or CLIMB or OPERATIONS</i>) [AT (<i>NOT ABOVE</i>)] (<i>altitude</i>) OWN TERRAIN CLEARANCE. b. CLIMB TO (<i>or DESCEND TO or OPERATE</i>) [AT (<i>NOT ABOVE</i>)] (<i>altitude</i>) MAINTAIN OWN TERRAIN CLEARANCE.
7. Specification of Cruising Levels reply to cruise climb request	a. CROSS (<i>significant point</i>) AT (<i>or ABOVE, or BELOW</i>) (<i>level</i>) b. CROSS (<i>significant point</i>) AT (<i>time</i>) OR LATER (<i>or BEFORE</i>) AT (<i>level</i>) c. CRUISE CLIMB NOT AVAILABLE (<i>reason</i>)
8. Where an aircraft operation requires random climb and descent at and below (or at and above) a specified level.	a. OPERATE NOT ABOVE (<i>or BELOW</i>) (<i>level</i>)
9. Termination of Identification and Control Services or Control Services only	a. [IDENTIFICATION AND] CONTROL SERVICE TERMINATED followed as necessary by: (i) [DUE (<i>reason</i>)] (ii) (<i>instructions</i>) (iii) FREQUENCY CHANGE APPROVED
10. When instructing an aircraft to turn 180° or more when tracking instructions follow	a. TURN LEFT (<i>or RIGHT</i>) - I SAY AGAIN - LEFT (<i>or RIGHT</i>) [<i>tracking instructions</i>]

6.7 Frequency Management

Circumstances	Phraseologies * Denotes pilot transmission
<p>1. Transfer of Control and/or Frequency Change</p> <p>pilot requesting to maintain radio silence for a specific time or event (e.g. fuel dump)</p> <p>nominating scheduled reporting times</p> <p><i>Note: An aircraft may be requested to "STANDBY" on a frequency when the intention is that the ATS unit will initiate communications, and to "MONITOR" a frequency when information is being broadcast thereon.</i></p> <p>an IFR pilot changing to the CTAF</p> <p>a pilot contacting next frequency when on a heading</p> <p>when a pilot/ATC broadcasts general information</p> <p>when a pilot broadcasts location specific general information</p> <p>notifying wake turbulence category to approach, departures, director or the aerodrome control tower</p> <p>ATC acknowledgment.</p>	<p>a. CONTACT (<i>unit callsign</i>) (<i>frequency</i>)</p> <p>b. *(<i>frequency</i>)</p> <p>c. AT (<i>or OVER</i>) (<i>time or place</i>) CONTACT (<i>unit callsign</i>) (<i>frequency</i>)</p> <p>d. IF NO CONTACT (<i>instructions</i>)</p> <p>e. *REQUEST CHANGE TO (<i>frequency</i>) (<i>service</i>)</p> <p>f. FREQUENCY CHANGE APPROVED</p> <p>g. *REQUEST TO MAINTAIN RADIO SILENCE DUE (<i>reason</i>) [UNTIL (<i>time</i>)]</p> <p>h. MONITOR (<i>unit callsign</i>) (<i>frequency</i>)</p> <p>i. *MONITORING (<i>frequency</i>)</p> <p>j. REMAIN THIS FREQUENCY</p> <p>k. REPORT followed as necessary by: (i) (<i>situation</i>) (ii) AT (iii) BY (iv) TIME (<i>time</i>)</p> <p>l. STANDBY FOR (<i>unit callsign</i>) (<i>frequency</i>)</p> <p>m. *CHANGING TO (<i>location</i>) CTAF (<i>frequency</i>)</p> <p>n. *HEADING (<i>as previously assigned</i>)</p> <p>o. *ALL STATIONS (<i>appropriate information</i>)</p> <p>p. *(<i>location</i>) TRAFFIC (<i>appropriate information</i>) (<i>location</i>)</p> <p>q. *SUPER (<i>or HEAVY</i>)</p> <p>r. *SUPER (<i>or HEAVY</i>)</p>

Circumstances	Phraseologies * Denotes pilot transmission
2. Flights Contacting Approach Control not identified or procedural tower	a. *(i) (<i>distance</i>) MILES (GNSS or DME) [FROM] (<i>aerodrome</i>) (ii) (<i>GNSS track</i>) TRACK ((or (VOR <i>radial</i>) RADIAL) or (STAR designator) or (<i>compass quadrant from aerodrome</i>) (iii) MAINTAINING (or DESCENDING TO) (<i>level</i>) (iv) VISUAL (<i>if visual approach can be made</i>) (v) INFORMATION (ATIS identification)
3. Change of Callsign to instruct an aircraft to change callsign to advise an aircraft to revert to the callsign indicated in the flight notification to ATS	a. CHANGE YOUR CALLSIGN TO (<i>new callsign</i>) [UNTIL FURTHER ADVISED] b. REVERT TO FLIGHT PLAN CALLSIGN (<i>callsign</i>) [AT (<i>significant point</i>)]
4. After Landing	a. CONTACT GROUND [frequency] b. WHEN VACATED CONTACT GROUND [frequency]
5. To request a station relay a clearance or information to a third party	a. FOR [RELAY TO] (<i>third party callsign</i>) (<i>clearance or information</i>)

6.8 Traffic Information

Circumstances	Phraseologies * Denotes pilot transmission
1. Traffic Information pilot request for traffic information to pass traffic information to acknowledge traffic information interception of relevant traffic information transmitted by other aircraft or ATS facility	a. *REQUEST TRAFFIC b. NO REPORTED [IFR] TRAFFIC c. [IFR] TRAFFIC (<i>relevant information</i>) [REPORT SIGHTING] d. [ADDITIONAL] [IFR] TRAFFIC (<i>direction</i>) BOUND (<i>type of aircraft</i>) (<i>level</i>) ESTIMATED (or OVER) (<i>significant point</i>) AT (<i>time</i>) e. *LOOKING f. *TRAFFIC IN SIGHT g. *NEGATIVE CONTACT [reasons] h. *COPIED (<i>callsign of traffic intercepted</i>)
2. Advice of Military Aircraft Conducting Abrupt Vertical Manoeuvres	a. ABRUPT VERTICAL MANOEUVRES AT (<i>position</i>) UP TO (<i>level</i>)
3. Advice of Military Low Jet Operations Known to be Taking Place	a. MILITARY LOW JET OPERATIONS (<i>relevant information</i>)

6.9 Meteorological Information

Circumstances	Phraseologies * Denotes pilot transmission
<p>1. Meteorological Conditions</p> <p><i>Note: Wind is always expressed by giving the mean direction and speed and any significant variations</i></p> <p>During RVR/RV operations where an assessment is not available or not reported</p> <p>Where multiple RVR/RV observations are made</p> <p><i>Note 1: Multiple RVR/RV observations are always representative of the touchdown zone, midpoint zone and the roll-out/stop end zone, respectively.</i></p> <p><i>Note 2: Where reports for three locations are given, the indication of these locations may be omitted, provided that the reports are passed in the order of touchdown zone, followed by the midpoint zone and ending with the roll-out/stop end zone report.</i></p> <p>When RVR/RV information on any one position is not available this information will be included in the appropriate sequence</p> <p>unless responding to a request for turbulence or icing information</p>	<p>a. [THRESHOLD] WIND (number) DEGREES (number) KNOTS</p> <p>b. WIND AT (height/altitude/flight level) (number) DEGREES (number) KNOTS</p> <p>c. WIND AT UP WIND END (number) DEGREES (number) KNOTS</p> <p>d. VISIBILITY (distance) [direction]</p> <p>e. RUNWAY VISUAL RANGE (RVR) or RUNWAY VISIBILITY (RV) [RUNWAY (number)] (distance) (for RV assessments - ASSESSED AT TIME (minutes))</p> <p>f. RUNWAY VISUAL RANGE (RVR) or RUNWAY VISIBILITY (RV) [RUNWAY (number)] NOT AVAILABLE (or NOT REPORTED)</p> <p>g. RUNWAY VISUAL RANGE (RVR) or RUNWAY VISIBILITY (RV) RUNWAY (number) (first position) (distance) (units), (second position) (distance) (units), (third position) (distance) (units) (for RV assessments - ASSESSED AT TIME (minutes))</p> <p>h. RUNWAY VISUAL RANGE (RVR) or RUNWAY VISIBILITY (RV) RUNWAY (number) (first position) (distance) (units), (second position) NOT AVAILABLE, (third position) (distance) (units) (for RV assessments - ASSESSED AT TIME (minutes))</p> <p>i. PRESENT WEATHER (details)</p> <p>j. CLOUD (amount, [type] and height of base) (or SKY CLEAR)</p> <p>k. CAVOK</p> <p>l. TEMPERATURE [MINUS] (number) (and/or DEWPOINT [MINUS] (number))</p> <p>m. QNH (number) [units]</p> <p>n. MODERATE (or SEVERE) ICING (or TURBULENCE) [IN CLOUD] (area)</p> <p>o. REPORT FLIGHT CONDITIONS</p> <p>p. *IMC (or VMC)</p>

6.10 Reports and Information

Circumstances	Phraseologies * Denotes pilot transmission
1. Position Reporting <i>Note: Phrases for use in en route position and MET reports are listed in ENR 1.1 APPENDIX 1.</i>	a. NEXT REPORT AT (<i>significant point</i>)
2. Additional Reports to request a report at a specified place or distance to request a report of present position when descending a non-DME equipped aircraft to LSALT above CTA steps the pilot will give this only when satisfied that the CTA step has been passed, allowing for navigational tolerances	a. REPORT PASSING (<i>significant point</i>) b. REPORT (<i>distance</i>) MILES [GNSS (<i>or</i>) DME]] FROM (<i>significant point</i>) c. REPORT PASSING (<i>three digits</i>) RADIAL (<i>name of VOR</i>) VOR d. REPORT [GNSS (<i>or</i>) DME]] DISTANCE FROM (<i>significant point</i>) e. REPORT PASSING CONTROL AREA STEPS FOR FURTHER DESCENT f. *INSIDE (<i>distance of a CTA step</i>) MILES
3. GNSS Tracking	a. CONFIRM (<i>or</i>) REPORT ESTABLISHED ON THE [(<i>three digits</i>)] GNSS TRACK [BETWEEN (<i>significant point</i>) AND (<i>significant point</i>)] b. MAINTAIN TRACK BETWEEN (<i>significant point</i>) AND (<i>significant point</i>). REPORT ESTABLISHED ON THE TRACK. c. *ESTABLISHED ON THE [(<i>three digits</i>)] TRACK [BETWEEN (<i>significant point</i>) AND (<i>significant point</i>)]
4. GNSS navigation GNSS unavailable Resuming GNSS operation	a. CONFIRM GNSS NAVIGATION b. *AFFIRM GNSS NAVIGATION c. *GNSS UNAVAILABLE [DUE TO (<i>reason e.g. LOSS OF RAIM or RAIM ALERT</i>)] d. *GNSS AVAILABLE [DUE TO (<i>reason</i>)]

<p align="center">Circumstances</p>	<p align="center">Phraseologies * Denotes pilot transmission</p>
<p>5. Aerodrome Information</p> <p><i>Note 1: See FIHA AD 1.2 Section 3 for information about runway condition reports.</i></p> <p><i>Note: Additional surface descriptors may apply in countries with polar weather conditions.</i></p> <p>Only for contaminants</p> <p>Taxiway conditions only reported if operationally significant. Apron conditions only reported if operationally significant. Where appropriate, any additional significant operational information about the surface conditions</p>	<p>a. RUNWAY (number) SURFACE CONDITION [CODE (three-digit number)] followed as necessary by:</p> <ul style="list-style-type: none"> (i) ISSUED AT (<i>date and time UTC</i>) (ii) WET [<i>or DRY, or SLIPPERY WET, or STANDING WATER, or FROST, or DRY SNOW, or WET SNOW or SLUSH</i>] (iii) DEPTH (<i>depth of deposit</i>) MILLIMETERS <i>or</i> NOT REPORTED) (iv) COVERAGE (<i>number</i>) PER CENT <i>or</i> NOT REPORTED) (v) TAXIWAY (<i>identification of taxiway</i>) POOR (vi) APRON (<i>identification of apron</i>) POOR (vii) Plain language remarks <p>b. [<i>location</i>] RUNWAY SURFACE CONDITION RUNWAY (<i>number</i>) NOT CURRENT</p> <p>c. LANDING SURFACE (<i>condition</i>)</p> <p>d. CAUTION (WORK IN PROGRESS) (OBSTRUCTION) (<i>position and any necessary advice</i>)</p> <p>e. BRAKING ACTION REPORTED BY (<i>aircraft type</i>) AT (<i>time</i>) GOOD (<i>or</i> GOOD TO MEDIUM, <i>or</i> MEDIUM, <i>or</i> MEDIUM TO POOR <i>or</i> POOR, <i>or</i> LESS THAN POOR)</p> <p>f. TAXIWAY WET [<i>or</i> STANDING WATER, FROST, <i>or</i> DRY SNOW, <i>or</i> WET SNOW <i>or</i> SLUSH]</p> <p>g. TOWER OBSERVES (<i>weather information</i>)</p> <p>h. PILOT REPORTS (<i>weather information</i>)</p>
<p>6. Information to Aircraft</p> <p>wake turbulence</p> <p>jet blast on apron or taxiway</p> <p>propeller-driven aircraft slipstream</p> <p>helicopter downwash</p>	<p>a. CAUTION</p> <ul style="list-style-type: none"> (i) WAKE TURBULENCE (ii) JET BLAST (iii) SLIPSTREAM (iv) DOWNWASH
<p>7. Pilot Initiated Waiver of Wake Turbulence Separation Standards</p>	<p>a. *ACCEPT WAIVER</p>
<p>8. ATS relay of information from aircraft operator to flight crew</p>	<p>a. YOUR COMPANY ADVISES (<i>information</i>)</p>

6.11 Clearances

<i>Circumstances</i>	<i>Phraseologies</i> * Denotes pilot transmission
1. Clearances	
	a. *REQUEST CLEARANCE
	b. CLEARED TO
If the route and/or level issued in the initial airways clearance is not in accordance with the Flight Plan	c. CLEARED TO (<i>destination</i>) [AMENDED ROUTE] (route clearance details) [AMENDED LEVEL] (level)
If an airways clearance is amended en route	d. RECLEARED (<i>amended clearance details</i>) [REST OF CLEARANCE UNCHANGED] (<i>level</i>)
	e. RECLEARED (<i>amended route portion</i>) TO (<i>significant point of original route</i>) [REST OF CLEARANCE UNCHANGED] (<i>level</i>)
when the clearance is relayed by a third party; e.g. pilot/FLIGHTWATCH (ATC excepted)	f. (<i>name of unit</i>) CLEARS (<i>aircraft identification</i>)
when clearance will be issued subject to a delay	g. REMAIN OUTSIDE CLASS (<i>airspace class</i>) (<i>or restricted</i>) [AND CLASS (<i>airspace class</i>)] AIRSPACE AND STANDBY
when clearance will be issued at a specified time or place	h. REMAIN OUTSIDE CLASS (<i>airspace class</i>) (<i>or restricted</i>) [AND CLASS (<i>airspace class</i>)] AIRSPACE, EXPECT CLEARANCE AT (<i>time/place</i>)
when a clearance will not be available	i. CLEARANCE NOT AVAILABLE, REMAIN OUTSIDE CLASS (<i>airspace class</i>) (<i>or restricted</i>) [AND CLASS (<i>airspace class</i>)] AIRSPACE
when requesting a deviation from cleared route	j. *REQUEST TO DEVIATE UP TO (<i>distance</i>) MILES LEFT (<i>or RIGHT</i>) OF ROUTE DUE (<i>reason</i>)
when requesting a deviation from cleared track	k. *REQUEST TO DEVIATE UP TO (<i>distance</i>) MILES LEFT (<i>or RIGHT</i>) OF TRACK DUE (<i>reason</i>)
when a deviation from cleared route or track is requested	l. DEVIATE UP TO (<i>distance</i>) MILES LEFT (<i>or RIGHT</i>) OF ROUTE (<i>or TRACK</i>)
when clearance for deviation cannot be issued	m. UNABLE, TRAFFIC (<i>direction</i>) BOUND (<i>type of aircraft</i>) (<i>level</i>) ESTIMATED (<i>or OVER</i>) (<i>significant point</i>) AT (<i>time</i>) CALLSIGN (<i>callsign</i>) ADVISE INTENTIONS
when a weather deviation has been completed and onwards clearance is requested	n. *CLEAR OF WEATHER [REQUEST (<i>route clearance</i>)]
when a weather deviation has been completed and the aircraft has returned to its cleared route	o. *BACK ON ROUTE (<i>or TRACK</i>)

Circumstances	Phraseologies * Denotes pilot transmission
<p>when subsequent restrictions/requirements are imposed in addition to previous restrictions to be complied with</p>	<p>p. FURTHER RESTRICTION</p> <p>q. [RE] ENTER CONTROLLED AIRSPACE (or CONTROL ZONE) [VIA (significant point)] AT (level) [AT (time)]</p> <p>r. LEAVE CONTROLLED AIRSPACE (or CONTROL ZONE) AT (level) (or CLIMBING, or DESCENDING)</p> <p>s. LEAVE AND RE-ENTER CONTROLLED AIRSPACE AT (level) (or CLIMBING TO (level), or DESCENDING TO (level) or ON (type of approach))</p> <p>t. JOIN (specify) AT (significant point) AT (level) [AT (time)]</p>
<p>2. Indication of Route and Clearance Limit</p> <p>issuing a specific clearance limit</p> <p>when a pilot requests, or ATC issues a visual departure in lieu of a SID</p>	<p>a. FROM (location) TO (location)</p> <p>b. TO (location) followed as necessary by: (i) DIRECT (ii) VIA (route and/or significant points) (iii) FLIGHT PLANNED ROUTE (iv) VIA (distance) DME ARC (direction) OF (name of DME station)</p> <p>c. (level or route) NOT AVAILABLE DUE (reason) ALTERNATIVE[S] IS/ARE (levels or routes) ADVISE</p> <p>d. CLEARANCE LIMIT (place/aid)</p> <p>e. [clearance details] VISUAL DEPARTURE</p>
<p>3. When a Clearance has been cancelled</p>	<p>a. CANCEL CLEARANCE</p> <p>b. *CANCEL CLEARANCE</p>
<p>4. Change of Flight Rules cancelling IFR (to be initiated only by the pilot)</p> <p>changing from VFR to IFR</p>	<p>a. *CANCEL IFR, [REQUEST] (intention)</p> <p>b. IFR CANCELLED OPERATE, OPERATE VFR (instruction or clearance)</p> <p>c. *CHANGE OF FLIGHT RULES, REQUEST IFR [CLEARANCE] [AT (time or place)] (IFR level)</p> <p>d. [AT (time or place)] OPERATE IFR, [CLEARED] (clearance or instructions)</p>

Circumstances	Phraseologies * Denotes pilot transmission
<p>5. Requesting Clearance</p> <p>when notification of flight details has not been submitted to ATS</p> <p>flight details to be passed after ATS response</p> <p>if clearance cannot be issued immediately upon request</p> <p>if giving warning of clearance requirement</p> <p>when requesting IFR Pick-up</p>	<p>a. *FLIGHT DETAILS [INBOUND or FOR (DEPARTURE or TRANSIT)]</p> <p>b. *(Aircraft type) (position) (route in controlled airspace and next estimate) (preferred level)</p> <p>c. EXPECT CLEARANCE AT (time or place)</p> <p>d. *EXPECT CLEARANCE REQUEST (aircraft type) VFR (if appropriate) FOR (destination) VIA (point outside controlled airspace at which clearance will be requested) ESTIMATE (estimate at destination) AT (altitude proposed for entry to controlled airspace)</p> <p>e. *REQUEST IFR PICK-UP</p>
<p>6. Pilot of IFR flight requests to climb to VFR-On-Top</p> <p>Pilot of an IFR flight is established VFR-On-Top</p> <p>Where vertical restrictions apply</p> <p>Pilot request to cancel VFR-On-Top</p> <p><i>Note: Full IFR separation is applied when ATC re-clears the aircraft to maintain an IFR level</i></p>	<p>a. *REQUEST VFR-ON-TOP</p> <p>b. CLIMB TO [(level)] AND REPORT REACHING VFR-ON-TOP, TOPS REPORTED (level), or NO TOPS REPORTS</p> <p>c. *VFR-ON-TOP</p> <p>d. MAINTAIN VFR-ON-TOP</p> <p>e. MAINTAIN VFR-ON-TOP AT OR BELOW/ABOVE/BETWEEN (level(s))</p> <p>f. *REQUEST (IFR level)</p> <p>g. MAINTAIN (IFR level)</p>
<p>7. VFR Departure</p> <p>Pilot of IFR flight requests VFR departure</p> <p>Pilot of IFR flight approved to depart VFR wishing to revert to IFR</p> <p><i>Note: The pilot is responsible for separation until IFR separation can be applied by ATC</i></p>	<p>a. *REQUEST VFR DEPARTURE</p> <p>b. VFR DEPARTURE APPROVED</p> <p>c. *REQUEST IFR CLEARANCE [AT (time or place)] (IFR level)</p>

Circumstances	Phraseologies * Denotes pilot transmission
Pilot of IFR flight having departed VFR, on first contact with ATC entering Class G airspace <i>Note: Pilots wishing to continue VFR should CANCEL IFR (refer sub-paragraph 4 above)</i>	d. *RESUMING IFR
8. Parachute Operations Clearance for parachutists to exit the aircraft and transit Restricted Area(s), Military Operating Area(s) or Classes A,C or D airspace	a. CLEAR TO DROP

6.12 SID

Circumstances	Phraseologies * Denotes pilot transmission
1. Issuing a SID	a. CLEARED (<i>SID designator</i>) DEPARTURE (<i>level instruction</i>)
2. Clearance to climb on a SID a. comply with published level restrictions b. follow the lateral profile of the SID c. comply with published speed restrictions and ATC-issued speed control instructions	a. CLIMB VIA SID TO (<i>level</i>)
3. During a SID climb: a. published level restrictions are cancelled b. follow the lateral profile of the SID c. comply with published speed restrictions and ATC-issued speed control instructions	a. [CLIMB VIA SID TO (<i>level</i>)], CANCEL LEVEL RESTRICTION(S)
4. During a SID climb: a. published level restrictions at the specified point(s) are cancelled b. follow the lateral profile of the SID c. comply with published speed restrictions and ATC-issued speed control instructions	a. [CLIMB VIA SID TO (<i>level</i>)], CANCEL LEVEL RESTRICTION(S) AT (<i>point(s)</i>)
5. During a SID climb: a. comply with published level restrictions b. follow the lateral profile of the SID c. published speed restrictions and ATC-issued speed control instructions are cancelled	a. [CLIMB VIA SID TO (<i>level</i>)], CANCEL SPEED RESTRICTION(S)

Circumstances	Phraseologies * Denotes pilot transmission
<p>6. During a SID climb:</p> <p>a. comply with published level restrictions b. follow the lateral profile of the SID c. published speed restriction are cancelled at the specific point(s) d. comply with ATC-issued speed control instructions</p>	<p>a. [CLIMB VIA SID TO <i>(level)</i>], CANCEL SPEED RESTRICTION(S) AT <i>(point(s))</i></p>
<p>7. During a SID climb:</p> <p>a. published level restrictions are cancelled b. follow the lateral profile of the SID c. published speed restrictions and ATC-issued speed control instructions are cancelled</p> <p><i>Note: the phrase 'CLIMB UNRESTRICTED TO...' is not used</i></p>	<p>a. [CLIMB TO <i>(level)</i>], CANCEL LEVEL AND SPEED RESTRICTIONS</p>
<p>8. Clearance to proceed direct during a SID:</p> <p>a. track direct to the specified waypoint and then follow the lateral profile of the SID b. published level and speed restrictions for bypassed waypoints are cancelled c. comply with published speed and level restrictions at and after the specified waypoint</p> <p><i>Note: direct tracking on a SID does not require a rejoin instruction</i></p>	<p>a. CLEARED DIRECT <i>(waypoint)</i></p>
<p>9. Initiation of vectoring during SID</p> <p>Clearance to proceed direct to a waypoint that is not on a SID</p>	<p>a. TURN LEFT <i>(or RIGHT)</i> HEADING <i>(three digits)</i> [<i>(reason)</i>], <i>(level instruction)</i>, [EXPECT TO REJOIN SID] [AT <i>(waypoint)</i>]</p> <p>b. CLEARED DIRECT <i>(waypoint)</i> <i>(level instruction)</i></p>
<p>10. Rejoining a SID</p>	<p>a. REJOIN SID <i>(or (SID designator))</i> [AT <i>(waypoint)</i>] [<i>(transition restrictions)</i>]</p>
<p>11. When a SID has been cancelled</p>	<p>a. CANCEL SID <i>(instructions)</i></p>

6.13 STAR

Circumstances	Phraseologies * Denotes pilot transmission
<p>1. Notification of STAR</p> <p>Clearance availability (on first contact) when associated with a frequency transfer</p> <p>Notification of STAR clearance availability when NOT associated with a frequency transfer</p>	<p>a. EXPECT STAR CLEARANCE</p> <p>b. STAR CLEARANCE AVAILABLE</p>
<p>2. Issuing a STAR clearance</p>	<p>a. CLEARED (<i>STAR designator</i>) ARRIVAL [(<i>name</i>) TRANSITION] [RUNWAY (<i>number</i>)] (<i>level instruction</i>)</p>
<p>3. Descend to the cleared level:</p> <p>a. comply with published level restrictions</p> <p>b. follow the lateral profile of the STAR</p> <p>c. comply with published speed restrictions and ATC-issued speed control instructions</p>	<p>a. DESCEND VIA STAR TO (<i>level</i>)</p>
<p>4. During a STAR descent:</p> <p>a. published level restrictions are cancelled</p> <p>b. follow the lateral profile of the STAR</p> <p>c. comply with published speed restrictions and ATC-issued speed control instructions</p>	<p>a. [DESCEND VIA STAR TO (<i>level</i>)], CANCEL LEVEL RESTRICTION(S)</p>
<p>5. During a STAR descent:</p> <p>a. published level restrictions at the specified point(s) are cancelled</p> <p>b. follow the lateral profile of the STAR</p> <p>c. comply with published speed restrictions and ATC-issued speed control instructions</p>	<p>a. [DESCEND VIA STAR TO (<i>level</i>)], CANCEL LEVEL RESTRICTION(S) AT (<i>point</i>(s))</p>
<p>6. During a STAR descent:</p> <p>a. comply with published level restrictions</p> <p>b. follow the lateral profile of the STAR</p> <p>c. published speed restrictions and ATC-issued speed control instructions are cancelled</p>	<p>a. [DESCEND VIA STAR TO (<i>level</i>)], CANCEL SPEED RESTRICTION(S)</p>
<p>7. During a STAR descent:</p> <p>a. comply with published level restrictions</p> <p>b. follow the lateral profile of the STAR</p> <p>c. published speed restrictions are cancelled at the specific point(s)</p> <p>d. comply with ATC-issued speed control instructions</p>	<p>a. [DESCEND VIA STAR TO (<i>level</i>)], CANCEL SPEED RESTRICTION(S) AT (<i>point</i>(s))</p>
<p>8. During a STAR descent:</p> <p>a. published level restrictions are cancelled</p> <p>b. follow the lateral profile of the STAR</p> <p>c. published speed restrictions and ATC-issued speed control instructions are cancelled</p> <p><i>Note: the phrase 'DESCEND UNRESTRICTED TO...' is not used</i></p>	<p>a. DESCEND TO (<i>level</i>), CANCEL LEVEL AND SPEED RESTRICTIONS</p>

Circumstances	Phraseologies * Denotes pilot transmission
<p>9. Clearance to proceed direct during a STAR:</p> <p>a. track direct to the specified waypoint and then follow the lateral profile of the STAR</p> <p>b. published level and speed restrictions for bypassed waypoints are cancelled</p> <p>c. comply with published speed and level restrictions at and after the specified waypoint</p> <p><i>Note: direct tracking on a STAR does not require a rejoin instruction</i></p>	<p>a. CLEARED DIRECT (<i>waypoint</i>)</p>
<p>10. Initiation of vectoring after STAR has been issued</p> <p>Clearance to proceed direct to a waypoint that is not on a STAR</p>	<p>a. TURN LEFT (<i>or RIGHT</i>) HEADING (<i>three digits</i>) [(<i>reason</i>)], (<i>level instruction</i>), [EXPECT TO REJOIN STAR] [AT (<i>waypoint</i>)]</p> <p>b. CLEARED DIRECT (<i>waypoint</i>) (<i>level instruction</i>)</p>
<p>11. Rejoining a STAR</p>	<p>a. REJOIN STAR (<i>or (STAR designator)</i>) [AT (<i>waypoint</i>)] [(<i>transition restrictions</i>)]</p>
<p>12. When a STAR clearance is cancelled</p>	<p>a. CANCEL STAR (<i>instructions</i>)</p>

6.14 Approach and Area Control Services

Circumstances	Phraseologies * Denotes pilot transmission
<p>1. Departures Instructions</p>	<p>a. TRACK (<i>three digits</i>) DEGREES [MAGNETIC] TO (<i>or FROM</i>) (<i>significant point</i>) [UNTIL (<i>time</i>) (<i>or REACHING</i>) (<i>fix or significant point or level</i>)]</p>
<p>2. Approach Instructions</p> <p><i>Note: See ENR 1.1 para 2.11.2.5 for further approach phraseology information.</i></p> <p>RNAV (GNSS) (or RNP APCH) approach via an IAF or IF</p> <p>RNAV (RNP) (or RNP AR APCH) approach where an aircraft has been subject to vectoring or random tracking and is subsequently re-cleared direct to the IAF.</p>	<p>a. CLEARED DME (<i>or GNSS</i>) ARRIVAL [SECTOR (<i>identifying letter of the sector</i>)]</p> <p>b. CLEARED (<i>type of approach</i>) APPROACH [RUNWAY (<i>number</i>)]</p> <p>c. * REQUEST [STRAIGHT-IN] [(<i>type of approach</i>)] APPROACH [RUNWAY (<i>number</i>)]</p> <p>d. CLEARED [STRAIGHT-IN] [(<i>type of approach</i>)] APPROACH [RUNWAY (<i>number</i>)]</p> <p>e. CLEARED (<i>type of approach</i>) APPROACH RUNWAY (<i>number</i>) FOLLOWED BY CIRCLING TO RUNWAY (<i>number</i>)</p> <p>f. * REQUEST (<i>type of approach</i>) APPROACH VIA (<i>last two letters of the IAF or IF designator</i>) [RUNWAY (<i>number</i>)]</p> <p>g. RECLEARED DIRECT (<i>last two letters of the IAF or IF designator</i>) CLEARED (<i>type of approach</i>) APPROACH [RUNWAY (<i>number</i>)]</p> <p>h. COMMENCE APPROACH AT (<i>time</i>)</p> <p>i. RECLEARED DIRECT (<i>IAF/Latest Intercept Point designator</i>) followed as necessary by:</p> <p>(i) TRACK VIA (<i>type of approach</i>) APPROACH [RUNWAY (<i>number</i>)] MAINTAIN (<i>or DESCEND TO</i>) (<i>level</i>)</p> <p>(ii) WHEN ESTABLISHED, CLEARED (<i>type of approach</i>) APPROACH [RUNWAY (<i>number</i>)]</p>
<p>3. Degradation of aircraft navigation performance</p>	<p>a. UNABLE RNP (<i>or RNAV</i>) (<i>specify type</i>) [DUE TO (<i>reason, e.g. LOSS OF RAIM or RAIM ALERT</i>)].</p>
<p>4. Temporary Level Restriction</p> <p>Where a temporary level restriction is to be imposed. (Applicable to civil aircraft during practice approaches in VMC; or MIL aircraft NPA, or precision if clearance will allow descent in accordance with procedure)</p>	<p>a. TRACK VIA (<i>type of approach</i>) APPROACH [RUNWAY (<i>number</i>)] NOT BELOW (<i>level</i>)</p>

GEN 3.4

Circumstances	Phraseologies * Denotes pilot transmission
<p>pilot to advise when able to conduct a visual approach</p> <p>visual approach (by day or night)</p> <p>visual approaches by night</p> <p>when including a VFR climb/descent instruction:</p> <ul style="list-style-type: none"> - when VFR descent clearance applies for the entire approach - when VFR descent clearance applies for a portion of the approach 	<p>b. REPORT VISUAL</p> <p>c. REPORT RUNWAY [LIGHTS] IN SIGHT</p> <p>d. REPORT (<i>significant point</i>) [OUTBOUND or INBOUND]</p> <p>e. CLEARED VISUAL APPROACH [RUNWAY (<i>number</i>)] [TRACKING VIA THE STAR]</p> <p>f. WHEN ESTABLISHED (<i>position</i>) CLEARED VISUAL APPROACH [RUNWAY (<i>number</i>)]</p> <p>g. DESCEND VFR, CLEARED (<i>type of approach</i>) APPROACH [RUNWAY (<i>number</i>)]</p> <p>h. CLEARED (<i>type of approach</i>) APPROACH [RUNWAY (<i>number</i>)] DESCEND VFR ABOVE (or BETWEEN) (<i>level/s</i>)</p>
<p>5. Holding Instructions</p> <p>visual</p> <p>published holding procedure over a waypoint, facility or fix</p> <p>when pilot requires an oral description of holding procedure based on a facility</p>	<p>a. HOLD VISUAL [OVER] (<i>position</i>)</p> <p>b. HOLD AT (<i>waypoint, facility or fix</i>) (<i>level</i>) EXPECT APPROACH (or FURTHER CLEARANCE) AT (<i>time</i>)</p> <p>c. *REQUEST HOLDING INSTRUCTIONS</p> <p>d. HOLD AT (<i>waypoint, facility or fix</i>) (<i>callsign and frequency, if necessary</i>) (<i>level</i>) INBOUND TRACK (<i>three digits</i>) DEGREES RIGHT (or LEFT) HAND PATTERN, OUTBOUND TIME (<i>number</i>) MINUTES (<i>additional instructions, if necessary</i>)</p> <p>e. HOLD ON THE (<i>three digits</i>) RADIAL OF THE (<i>name</i>) VOR/TACAN (<i>callsign and frequency, if necessary</i>) AT (<i>distance</i>) DME (or BETWEEN (<i>distance</i>) AND (<i>distance</i>) DME) (<i>level</i>) INBOUND TRACK (<i>three digits</i>) DEGREES RIGHT (or LEFT) HAND PATTERN (<i>additional instructions, if necessary</i>)</p>
<p>6. To advise ATC of Minimum Fuel Status</p> <p>ATC acknowledgment of Minimum Fuel status</p> <p><i>Note: Advice of fuel status must be made to each subsequent ATC sector on frequency transfer and ATC will acknowledge the status</i></p>	<p>a. *MINIMUM FUEL</p> <p>b. MINIMUM FUEL ACKNOWLEDGED [NO DELAY EXPECTED or EXPECT (<i>delay information</i>)]</p>
<p>7. Expected Approach Time</p>	<p>a. NO DELAY EXPECTED</p> <p>b. EXPECTED APPROACH TIME (<i>time</i>)</p>

6.15 Phraseologies to be used related to CPDLC

Circumstances	Phraseologies * Denotes pilot transmission
<p>1. Operational Status</p> <p>failure of CPDLC</p> <p>failure of a single CPDLC message</p> <p>to correct CPDLC clearances, instructions, information or requests</p> <p>to instruct all stations or a specific flight to avoid sending CPDLC requests for a limited period of time</p> <p>to instruct the flight crew to manually initiate a logon to the subsequent ATSU</p> <p>to advise the flight crew prior to the commencement of a CPDLC shutdown and instruct them to continue on voice</p> <p>to resume normal use of CPDLC</p>	<p>a. [ALL STATIONS] CPDLC FAILURE (<i>instructions</i>)</p> <p>b. CPDLC MESSAGE FAILURE (<i>appropriate clearance, instruction, information or request</i>)</p> <p>c. DISREGARD CPDLC (<i>message type</i>) MESSAGE, BREAK (<i>correct clearance, instruction, information or request</i>)</p> <p>d. [ALL STATIONS] STOP SENDING CPDLC REQUESTS [UNTIL ADVISED] [(REASON)]</p> <p>e. DISCONNECT CPDLC THEN LOGON TO [<i>facility designation</i>]</p> <p>f. CPDLC WILL BE SHUT DOWN, DISCONNECT CPDLC, CONTINUE ON VOICE</p> <p>g. [ALL STATIONS] RESUME NORMAL CPDLC OPERATIONS</p>

6.16 Vicinity of Aerodrome

6.16.1 Visual Identification

Circumstances	Phraseologies * Denotes pilot transmission
1. Identification of Aircraft	a. SHOW LANDING LIGHT
2. Acknowledgment by Visual Means	<p>a. ACKNOWLEDGE BY MOVING AILERONS (<i>or</i> RUDDER)</p> <p>b. ACKNOWLEDGE BY ROCKING WINGS</p> <p>c. ACKNOWLEDGE BY FLASHING LANDING LIGHTS</p>
3. ADF - Aircraft enters the ATZ with incorrect anti-collision lighting	a. CHECK STROBES

6.16.2 Starting and Initial Clearance Issue

Circumstances	Phraseologies * Denotes pilot transmission
<p>1. Starting Procedures</p> <p>to request permission to start engines</p> <p>ATC response</p>	<p>a. *[<i>aircraft location</i>] REQUEST START</p> <p>b. *[<i>aircraft location</i>] REQUEST START INFORMATION (<i>ATIS identification</i>)</p> <p>c. START APPROVED</p>

GEN 3.4

Circumstances	Phraseologies * Denotes pilot transmission
	d. START AT (<i>time</i>) e. EXPECT START AT (<i>time</i>) f. EXPECT DEPARTURE (<i>time</i>) START AT OWN DISCRETION
2. When clearance delivery is in operation if runway other than runway nominated is required	a. *(<i>flight number, if any</i>) TO (<i>aerodrome of first intended landing</i>) REQUEST CLEARANCE b. *REQUIRE RUNWAY (<i>number</i>)

6.16.3 Pushbacks

Circumstances	Phraseologies * Denotes pilot transmission
1. Pushback Procedures for Aircraft <i>Note: Where a pushback does not enter the manoeuvring area, ERSA will specify the frequency on which apron service is provided.</i>	a. *[<i>aircraft location</i>] REQUEST PUSHBACK b. PUSHBACK APPROVED [TAIL (<i>direction e.g. North or Right</i>)] c. PUSHBACK AT OWN DISCRETION [TAIL (<i>direction e.g. Left or West</i>)] d. EXPECT (<i>number</i>) MINUTES DELAY DUE (<i>reason</i>)
2. Towing Procedures ATC response	a. #REQUEST TOW [<i>company name</i>] (<i>aircraft type</i>) FROM (<i>location</i>) TO (<i>location</i>) b. TOW APPROVED VIA (<i>specific routing to be followed</i>) #Denotes transmission from aircraft/tow vehicle combination
3. To Request time check and/or aerodrome data for departure when no ATIS broadcast is available <i>Note: If multiple visibility, RVR or RV observations are available, those that represent the roll-out/stop end zone should be used for take-off.</i>	a. *REQUEST TIME CHECK b. TIME (<i>time</i>) c. *REQUEST DEPARTURE INFORMATION d. RUNWAY (<i>number</i>), WIND (<i>direction and speed</i>)(<i>units</i>) QNH (<i>number</i>)(<i>units</i>) TEMPERATURE [MINUS (<i>number</i>), [VISIBILITY (or RUNWAY VISUAL RANGE or RVR or RUNWAY VISIBILITY) (<i>distance</i>)(<i>units</i>)], [TIME(<i>time</i>)]

6.16.4 Taxi Procedure

<p style="text-align: center;">Circumstances</p>	<p style="text-align: center;">Phraseologies * Denotes pilot transmission</p>
<p>1. Taxi Procedures</p> <p>for departure at a controlled aerodrome</p> <p>for departure at a non-controlled aerodrome</p> <p>military pilots on local sorties when ready to taxi (include details of flight if not already notified)</p> <p>where detailed taxi instructions are required</p> <p>where aerodrome information is not available from an alternative source such as ATIS</p> <p>for arrival at a controlled aerodrome</p>	<p>a. *[flight number] [aircraft type] [wake turbulence category if SUPER or HEAVY] [POB (number)] [DUAL (or SOLO)] INFORMATION (ATIS identification) [SQUAWK (SSR code)] [aircraft location] [flight rules, if IFR] [TO (aerodrome of destination)] REQUEST TAXI [intentions]</p> <p>b. *(aircraft type) [POB (number)] [IFR (if operating IFR)] TAXIING (location) FOR (destination or intentions) RUNWAY (number)</p> <p>c. *(number of aircraft) FOR (area of operation) POB (number) [DANGEROUS CARGO] INFORMATION (ATIS identification) REQUEST TAXI</p> <p>d. TAXI TO (HOLDING POINT [identifier] or intermediate point) RUNWAY (number) [TIME (minutes)]</p> <p>e. *([HOLDING POINT] (identifier) or intermediate point), RUNWAY (number)</p> <p>f. *[aircraft type] REQUEST DETAILED TAXI INSTRUCTIONS</p> <p>g. TAXI VIA (specific routing to be followed) TO HOLDING POINT (identifier) [RUNWAY (number)] [TIME (minutes)]</p> <p>h. *[HOLDING POINT] (identifier), RUNWAY (number)</p> <p>i. TAXI TO HOLDING POINT (identifier) (followed by aerodrome information as applicable) [TIME (minutes)]</p> <p>j. *[HOLDING POINT] (identifier)</p> <p>k. *(aircraft callsign) [parking area or bay number]</p> <p>l. TAXI TO [TERMINAL or other location; e.g., GENERAL AVIATION AREA] [STAND (number)]</p>
<p>2. Intersection Departures</p> <p>when a pilot requests an intersection departure</p> <p>when a pilot is offered an intersection departure</p> <p>when a pilot accepts an intersection departure</p>	<p>a. *REQUEST INTERSECTION DEPARTURE FROM (taxiway identifier)</p> <p>b. TAXI TO HOLDING POINT (taxiway identifier) [RUNWAY (number)]</p> <p>c. INTERSECTION DEPARTURE AVAILABLE FROM (taxiway identifier) (distance) REMAINING (if this information is not readily available to the pilot)</p> <p>d. TAXI TO HOLDING POINT (taxiway identifier) [RUNWAY (number)]</p>

Circumstances	Phraseologies * Denotes pilot transmission
3. Specific Routing	a. TAKE (or TURN) FIRST (or SECOND) LEFT (or RIGHT) b. TAXI VIA (identification of taxiway) c. TAXI VIA RUNWAY (number)
4. Manoeuvring on Aerodrome general <i>Note: The pilot must, when requested, report "RUNWAY VACATED" when the aircraft is well clear of the runway.</i>	a. *REQUEST BACKTRACK b. BACKTRACK APPROVED c. BACKTRACK RUNWAY (number) d. *[aircraft location] REQUEST TAXI TO (destination on aerodrome) e. TAXI STRAIGHT AHEAD f. TAXI WITH CAUTION (reason) g. GIVE WAY TO (description and position of other aircraft) h. *GIVING WAY TO (traffic) i. TAXI INTO HOLDING BAY j. FOLLOW (description of other aircraft or vehicle) k. VACATE RUNWAY l. *RUNWAY VACATED m. EXPEDITE TAXI [reason] n. *EXPEDITING
5. ATFM Ground Delay Program Calculated Off Block Time (COBT) non-compliance - early request for taxi clearance	a. PUSH BACK (or TAXI) CLEARANCE NOT AVAILABLE DUE FLOW MANAGEMENT, EXPECT CLEARANCE AT TIME (COBT minus 5 minutes)

6.16.5 Aerodrome Movements

<p style="text-align: center;">Circumstances</p>	<p style="text-align: center;">Phraseologies * Denotes pilot transmission</p>
<p>1. Holding</p> <p><i>Note: The procedure words ROGER and WILCO are insufficient acknowledgment of the instructions HOLD, HOLD POSITION and HOLD SHORT OF (position). In each case, the acknowledgment must be by the phraseology HOLDING or HOLDING SHORT, as appropriate.</i></p>	<ul style="list-style-type: none"> a. HOLD (direction) OF (position, runway number, etc.) b. HOLD POSITION c. HOLD SHORT OF (position) d. *HOLDING e. *HOLDING SHORT
<p>2. To Cross a Runway</p> <p><i>Note: If the control tower is unable to see the crossing aircraft (e.g., night, low visibility, etc.), the instruction should always be accompanied by a request to report when the aircraft has vacated and is clear of the runway.</i></p>	<ul style="list-style-type: none"> a. *AT (or ON) (location) REQUEST CROSS RUNWAY (number) b. AT (or ON) (location) CROSS RUNWAY (number) [REPORT VACATED] c. *AT (or ON) (location) CROSSING RUNWAY (number) d. EXPEDITE CROSSING RUNWAY (number) TRAFFIC (aircraft type) (distance) MILES FINAL
<p>3. To Enter a Runway (not used in conjunction with clearance to line-up or enter the Operational Readiness Platform)</p> <p><i>Note: If the control tower is unable to see the relevant aircraft (e.g. night, low visibility, etc.), the instruction should always be accompanied by a request to report when the aircraft has vacated and is clear of the runway.</i></p>	<ul style="list-style-type: none"> a. *[AT (or ON) (location)] REQUEST ENTER RUNWAY (number) b. AT (or ON) (location) ENTER RUNWAY (number) [REPORT VACATED] c. *AT (or ON) (location) ENTER RUNWAY (number)

6.16.6 Runway Operations

Note: During multiple runway operations where the possibility of confusion exists, the runway number will be stated. The runway number may be stated if the caller wishes to emphasise the runway to be used. For parallel runway operations on discrete frequencies, at Class D aerodromes, the runway number may be omitted.

Circumstances	Phraseologies * Denotes pilot transmission
<p>1. Preparation for Take-off</p> <p>at Class D aerodromes when reporting ready and parallel runway operations are in progress</p> <p>when reporting ready for operations wholly within Class D CTR or departure from Class D CTR not in receipt of airways clearance for operations</p> <p>outside Class D airspace.</p>	<p>a. REPORT WHEN READY [FOR DEPARTURE]</p> <p>b. READY, RUNWAY (<i>runway</i>)</p> <p>c. *READY [intentions] [(<i>circuit operations, tracking details, departure procedures, etc.</i>)]</p> <p>d. ARE YOU READY FOR IMMEDIATE DEPARTURE?</p> <p>e. *READY</p>
<p>2. Clearance to Enter Runway and Await Take-off</p> <p>when the pilot desires to enter the runway and assume take-off position for checks before departure</p> <p>conditional clearances</p> <p>acknowledgment of a conditional clearance</p> <p>when stop bar contingency procedures are in force</p>	<p>a. *REQUEST LINE-UP [REQUIRE (<i>required number of seconds delay in lined-up position before departure</i>) SECONDS ON RUNWAY]</p> <p>b. LINE UP [RUNWAY (<i>number</i>)] [AND WAIT] [BE READY FOR IMMEDIATE DEPARTURE]</p> <p>c. (<i>condition</i>) LINE UP [RUNWAY (<i>number</i>)](brief reiteration of condition)</p> <p>d. *(<i>condition</i>) LINE UP [RUNWAY (<i>number</i>)] [AND WAIT]</p> <p>e. AT (<i>holding point</i>), CROSS THE ILLUMINATED STOP BAR, LINE UP (<i>or</i>) CLEARED FOR TAKE-OFF <i>or</i> ENTER <i>or</i> CROSS) RUNWAY (<i>number</i>)</p> <p>f. *AT (<i>holding point</i>), CROSS THE ILLUMINATED STOP BAR, LINE UP (<i>or</i>) CLEARED FOR TAKE-OFF <i>or</i> ENTER <i>or</i> CROSS) RUNWAY (<i>number</i>)</p>
<p>3. Take-off Clearance</p> <p>multiple runway operations, other than Class D aerodromes where aircraft are operating on parallel runways using discrete frequencies</p> <p>when takeoff clearance has not been complied with</p>	<p>a. CLEARED FOR TAKE-OFF [REPORT AIRBORNE]</p> <p>b. RUNWAY (<i>number</i>) CLEARED FOR TAKE-OFF</p> <p>c. TAKE OFF IMMEDIATELY OR VACATE RUNWAY</p> <p>d. TAKE OFF IMMEDIATELY OR HOLD SHORT OF THE RUNWAY</p>

Circumstances	Phraseologies * Denotes pilot transmission
<p>when LAHSO are in use</p> <p>when a RADAR SID has been issued</p> <p>when an IFR aircraft is cleared for a visual departure to a level at or above the MVA or MSA/LSALT</p> <p>when a VFR aircraft, or an IFR aircraft cleared for a visual departure is issued RADAR heading instructions</p> <p>when an IFR aircraft cleared for a visual departure is assigned a level below the MVA or MSA/LSALT in the departure instructions</p> <p>when the airways clearance issued to an IFR aircraft includes a visual departure and a level below the MVA or MSA/LSALT and no turn on departure required</p>	<p>e. (aircraft type) LANDING ON CROSSING RUNWAY WILL HOLD SHORT - RUNWAY (number) CLEARED FOR TAKE-OFF</p> <p>f. ASSIGNED HEADING [LEFT (or RIGHT)] (three digits) [(altitude restriction)] [RUNWAY (number)] CLEARED FOR TAKE-OFF</p> <p>g. *HEADING (or LEFT or RIGHT) (three digits) [(any altitude restriction)] [RUNWAY (number)] CLEARED FOR TAKE-OFF</p> <p>h. TRACK EXTENDED CENTRE LINE (three digits) DEGREES [(altitude restriction)] [RUNWAY (number)] CLEARED FOR TAKE-OFF</p> <p>i. (instructions) [RUNWAY (number)] CLEARED FOR TAKE-OFF, [MAKE LEFT (or RIGHT) TURN]</p> <p>j. *(instructions) [RUNWAY (number)] CLEARED FOR TAKE-OFF, [LEFT (or RIGHT) TURN]</p> <p>k. (instructions) MAINTAIN RUNWAY HEADING (or TURN LEFT (or RIGHT) HEADING (three digits)) VISUAL, [(altitude restriction)] [RUNWAY (number)] CLEARED FOR TAKE-OFF</p> <p>l. *(instructions) RUNWAY HEADING (or LEFT (or RIGHT) HEADING (three digits)) VISUAL, [(altitude restriction)] [RUNWAY (number)] CLEARED FOR TAKE-OFF</p> <p>m. (instructions) CLIMB TO (level) VISUAL, [RUNWAY (number)] CLEARED FOR TAKE-OFF</p> <p>n. *(instructions) (level) VISUAL, [RUNWAY (number)] CLEARED FOR TAKE-OFF</p> <p>o. [RUNWAY (number)] CLEARED FOR TAKE-OFF, VISUAL</p>
<p>4. Take-off Clearance Cancellation</p> <p>to stop a takeoff in emergency conditions NOTE: Used only when an aircraft is in imminent danger.</p>	<p>a. HOLD POSITION, CANCEL, I SAY AGAIN CANCEL TAKE-OFF (reasons)</p> <p>b. *HOLDING</p> <p>c. STOP IMMEDIATELY (repeat aircraft call/sign) STOP IMMEDIATELY (reason)</p> <p>d. *STOPPING RUNWAY (number)</p>

6.16.7 Helicopter Operations

Circumstances	Phraseologies * Denotes pilot transmission
1. Helicopter Operations air taxi or air transit for departure and arrival	a. *REQUEST AIR TAXI (or AIR TRANSIT or GROUND TAXI) FROM (or VIA) TO (location or routing as appropriate) b. AIR TAXI (or AIR TRANSIT or GROUND TAXI) TO (or VIA) (location, parking position, stand, or routing as appropriate) [CAUTION (dust, loose debris, taxiing light aircraft, personnel, wake turbulence, etc.)] c. AIR TAXI (or AIR TRANSIT or GROUND TAXI) VIA (direct, as requested, or specified route) TO (location, heliport, parking position, stand, operating or movement area, or runway) AVOID (aircraft or vehicles or personnel)
2. Departure from: a RWY, or HLS visible to the tower and located on a manoeuvring area subject to ATC departure other than above	a. (instructions as appropriate, position or runway) CLEARED FOR TAKE-OFF b. (instructions as appropriate) [DEPARTURE APPROVED] REPORT AIRBORNE
3. Arrival to: a RWY, or HLS visible to the tower and located within a manoeuvring area subject to ATC Arrival other than above	a. (instructions as appropriate, position or runway) CLEARED TO LAND b. CLEARED VISUAL APPROACH (instructions as appropriate), REPORT ON THE GROUND

6.16.8 After Take-off

Note: ALL "level" reports within ATS surveillance system coverage must be to the nearest 100FT.

<p>Circumstances</p>	<p>Phraseologies * Denotes pilot transmission</p>
<p>1. Tracking After Take-Off</p> <p>when instructing an aircraft to 180° or more after take-off</p> <p>heading to be followed</p> <p>when a specific track is to be followed</p>	<p>a. *REQUEST RIGHT (or LEFT) TURN [WHEN AIRBORNE]</p> <p>b. LEFT (or RIGHT) TURN APPROVED</p> <p>c. AFTER PASSING (level) (instructions)</p> <p>d. MAKE LEFT (or RIGHT) - I SAY AGAIN - LEFT (or RIGHT) TURN</p> <p>e. CONTINUE ON (magnetic direction of runway) (instructions)</p> <p>f. TRACK (magnetic direction of runway) (instructions)</p> <p>g. CLIMB STRAIGHT AHEAD (instructions)</p>
<p>2. Airborne Report</p> <p>where an ATS surveillance service is provided; an unrestricted turn to track (including SID)</p> <p>heading specified by ATC</p> <p>confirmation of an assigned RADAR SID heading when establishing contact with ATC and unable to execute turn immediately due procedural requirements</p> <p>when assigned heading approximates runway bearing</p>	<p>a. *PASSING (level) CLIMBING TO (level)</p> <p>b. *TURNING LEFT (or RIGHT) (three digits) PASSING (level) CLIMBING TO (level) or</p> <p>c. *MAINTAINING RUNWAY HEADING PASSING (level) CLIMBING TO (level)</p> <p>d. *ASSIGNED HEADING LEFT (or RIGHT) (three digits) PASSING (level) CLIMBING TO (level)</p> <p>e. *HEADING (three digits) PASSING (level) CLIMBING TO (level)</p>
<p>3. Departure Report</p> <p>when notifying departure report to a Class D control tower</p> <p>non-controlled aerodromes - no ATS surveillance</p> <p>non-controlled aerodromes - ATS surveillance when notifying departure, and identification is expected with the departure report</p>	<p>a. *TRACKING (track being flown) FROM (reference aid used to establish track) or VIA (SID identifier) CLIMBING TO (level)</p> <p>b. *DEPARTED (location) (time in minutes) TRACKING [TO INTERCEPT] (track) CLIMBING TO (intended level) ESTIMATING (first reporting point) AT (time)</p> <p>c. *(location reference departure aerodrome) PASSING (current level) CLIMBING TO (intended level) ESTIMATING (first reporting point) AT (time)</p>

6.16.9 Arrival At Aerodrome

<p>Circumstances</p>	<p>Phraseologies * Denotes pilot transmission</p>
<p>1. Entering an Aerodrome Traffic Circuit when ATIS information is available</p>	<p>a. *[aircraft type] (position) (level) (intentions) b. *[aircraft type] (position) (level) INFORMATION (ATIS identification) (intentions) c. JOIN (instruction) RUNWAY (number) [(level)] [QNH (detail)] [TRAFFIC (detail)] [TRACK (requirements)] d. OVERFLY [(circuit direction)] RUNWAY (number) [(level)] [QNH (detail)] [TRAFFIC (detail)] [TRACK (requirements)]</p>
<p>2. In the Circuit when advising or requesting a non-standard circuit</p> <p>nearing position at which approach must be aborted if not cleared to land</p> <p><u>Abnormal Operations/Doubt Exists</u> - (additional phrases) For a civil aircraft, when doubt exists as to whether the gear is fully extended, or when a general aviation aircraft with retractable undercarriage has experienced abnormal operations</p> <p><u>Military Pilots</u> - (additional phrases) routine circuit reports must be made as and when arranged</p> <p>to sequence for downwind</p> <p>base call and wheel check (on reaching the base leg of a circuit, each aircraft, whether in stream landing or single, is to call tower and advise undercarriage down)</p> <p>ATC wheels check will include hook check for all hook cable operations</p>	<p>a. *(position in circuit, e.g. DOWNWIND/FINAL) b. *(position in circuit, e.g. DOWNWIND/FINAL) [GLIDE APPROACH, FLAPLESS APPROACH] c. [NUMBER (sequence number)] FOLLOW (aircraft type and position) [additional instructions if required] d. *BASE (or CROSSWIND) e. *FINAL (or LONG FINAL) f. *SHORT FINAL g. CHECK GEAR DOWN [AND LOCKED] h. *GEAR DOWN [AND LOCKED] i. *LEFT (or RIGHT) INITIAL j. PITCH LONG (or SHORT) k. *BASE GEAR GREEN (or THREE GREENS or THREE WHEELS) l. (instruction) CHECK WHEELS m. *(readback) (activate beeper) or n. *(readback) GEAR GREEN (or THREE GREENS or THREE WHEELS) o. APPROACH/DEPARTURE END CABLE UP (instruction) CHECK WHEELS AND HOOK p. *(readback) HOOK DOWN (activate beeper)</p>
<p>3. Arriving at an Aerodrome - Military Formations Circuit Area</p>	<p>a. * (formation callsign), BASE THREE GREENS (or GEAR GREEN or THREE WHEELS) b. (formation callsign) (instruction) CHECK WHEELS</p>

Circumstances	Phraseologies * Denotes pilot transmission
<p>Lead aircraft undercarriage status report</p> <p>Subsequent formation aircraft undercarriage status report</p> <p>Pairs Landing</p> <p>In-trail Landing</p>	<p>c. * (individual callsign) (activate beeper) or</p> <p>d. * THREE GREENS (or GEAR GREEN or THREE WHEELS) (individual callsign)</p> <p>e. * (individual callsign), THREE GREENS (or GEAR GREEN or THREE WHEELS) (activate beeper if fitted)</p> <p>f. CALLSIGN</p> <p>g. * (formation callsign), OUTER MARKER (or FINAL APPROACH FIX) SIX GREENS (or GEAR GREEN or SIX WHEELS)</p> <p>h. (formation callsign) CLEARED TO LAND, CHECK WHEELS</p> <p>i. * LAND (individual callsign) (activate beeper if fitted)</p> <p>j. * (individual callsign) (activate beeper if fitted)</p> <p>k. * (formation callsign)</p> <p>l. * (formation callsign) IN TRAIL, OUTER MARKER (or FINAL APPROACH FIX) THREE GREENS (or GEAR GREEN or THREE WHEELS)</p> <p>m. (formation callsign) IN TRAIL CLEARED TO LAND, CHECK WHEELS</p> <p>n. * LAND (callsign) 1 (activate beeper if fitted)</p> <p>o. * (callsign) 2 OUTER MARKER (or FINAL APPROACH FIX) THREE GREENS (or GEAR GREEN or THREE WHEELS) (activate beeper if fitted)</p> <p>p. * (callsign) 3 OUTER MARKER (or FINAL APPROACH FIX) THREE GREENS (or GEAR GREEN or THREE WHEELS) (activate beeper if fitted)</p> <p>q. CALLSIGN</p>
<p>4. Speed Adjustments - Military Aircraft military ATC instruction</p>	<p>a. REDUCE TO CIRCUIT SPEED</p> <p>b. REDUCE TO APPROACH SPEED</p> <p>c. REDUCE TO MINIMUM SAFE SPEED</p>
<p>5. Approach Instructions</p> <p><i>Note: The report "LONG FINAL" is made when aircraft turn on to final approach at a distance greater than 4NM from touchdown or when an aircraft on a straight-in approach is 8NM from touchdown. In both cases, a report "FINAL" is required at 4NM from touchdown.</i></p>	<p>a. MAKE SHORT APPROACH</p> <p>b. MAKE LONG APPROACH (or EXTEND DOWNWIND)</p> <p>c. REPORT BASE (or FINAL or LONG FINAL)</p> <p>d. CONTINUE APPROACH</p>
<p>6. Landing</p>	<p>a. CLEARED TO LAND (or TOUCH AND GO) (or STOP AND GO)</p>

Circumstances	Phraseologies * Denotes pilot transmission
<p>multiple runway operations, other than Class D aerodromes where aircraft are operating on parallel runways using discrete frequencies.</p> <p>where the aircraft cannot be sighted by ATC</p> <p>pilot requesting option for touch and go, full stop, stop and go, or go around</p> <p>advising the pilot the option to touch and go, full stop, stop and go, or go around</p> <p>where ATC require the aircraft to make a full stop landing during the conduct of circuit operations</p> <p>when runway is occupied and ATC assessment is that the runway will not become available.</p>	<p>b. RUNWAY (number) CLEARED TO LAND (or TOUCH AND GO) (or STOP AND GO)</p> <p>c. [RUNWAY (number)] NOT IN SIGHT - CLEARED TO LAND</p> <p>d. *(position in circuit) REQUEST THE OPTION</p> <p>e. [RUNWAY (number)] CLEARED FOR THE OPTION</p> <p>f. MAKE FULL STOP (reason) CLEARED TO LAND</p> <p>g. AT THE MINIMA GO AROUND</p>
<p>7. When Landing Approved and LAHSO Are in Use</p> <p>required readback</p> <p>When the full length of the landing runway subsequently becomes available</p> <p>Where an aircraft operating on a flight number callsign cannot participate in LAHSO</p>	<p>a. (aircraft type) DEPARTING (or LANDING) ON CROSSING RUNWAY, HOLD SHORT RUNWAY (number) CLEARED TO LAND RUNWAY (number)</p> <p>b. *HOLD SHORT RUNWAY (number) CLEARED TO LAND RUNWAY (number)</p> <p>c. FULL RUNWAY LENGTH NOW AVAILABLE</p> <p><i>Note: The 'hold short' lights will remain illuminated even though the full length of the runway is available.</i></p> <p>d. *NEGATIVE ACTIVE (or PASSIVE or ACTIVE AND PASSIVE) LAHSO</p>
<p>8. When a Pilot advises that an "Autoland", "Coupled" or similar approach is being made and the ILS Critical Area is Not Protected</p> <p><i>Note: Not applicable for GLS</i></p>	<p>a. ILS CRITICAL AREA NOT PROTECTED</p>
<p>9. Delaying Aircraft</p>	<p>a. ORBIT RIGHT (or LEFT) [FROM PRESENT POSITION]</p>
<p>10. Pilot Request for Low Approach or Pass to make an approach along a runway descending to an agreed minimum level</p> <p>to fly past the control tower or other observation point for the purpose of visual inspection by persons on the ground</p>	<p>a. *REQUEST LOW APPROACH (reasons) CLEARED LOW APPROACH [RUNWAY (number)] [(altitude restriction)] [(go around instructions)]</p> <p>b. *REQUEST LOW PASS (reasons) CLEARED LOW PASS [RUNWAY (number)] [(altitude restriction)] [(go around instructions)]</p>
<p>11. Missed Approach to discontinue an approach</p> <p>multiple runway operations</p>	<p>a. GO AROUND [TRACK EXTENDED CENTRE LINE (three digits) DEGREES (or instructions)]</p> <p>b. *GOING AROUND</p> <p>c. *GOING AROUND RUNWAY (number)</p>

6.17 ATS Surveillance Service Phraseologies

6.17.1 General Phrases

Circumstances	Phraseologies * Denotes pilot transmission
1. Identification of Aircraft	a. REPORT HEADING [AND FLIGHT LEVEL (or ALTITUDE)] b. FOR IDENTIFICATION TURN LEFT (or RIGHT) HEADING (<i>three digits</i>) c. IDENTIFIED [<i>position</i>] d. NOT IDENTIFIED [<i>reason</i>], [RESUME (or CONTINUE) OWN NAVIGATION]
2. Termination of ATS Surveillance Service	a. IDENTIFICATION TERMINATED [DUE (<i>reason</i>)](<i>instructions</i>) [FREQUENCY CHANGE APPROVED] b. WILL SHORTLY LOSE IDENTIFICATION (<i>appropriate instructions or information</i>) c. IDENTIFICATION LOST [<i>reasons</i>] (<i>instructions</i>)
3. ATS Surveillance System to request traffic, position, and/or navigation information to provide position information	a. *REQUEST (i) ATS SURVEILLANCE ASSISTANCE (<i>reason</i>) (ii) POSITION [WITH REFERENCE TO (<i>aid or location</i>)] (iii) TRAFFIC (or POSITION or NAVIGATION) ADVISORY [BY SURVEILLANCE] b. POSITION (distance) (direction) OF (significant point) (or OVER or ABEAM (significant point))
4. To request initiation or continuation of an ongoing SIS to terminate an ongoing SIS where ongoing service is not available	a. *REQUEST [HAND-OFF FOR] FLIGHT FOLLOWING b. *CANCEL FLIGHT FOLLOWING c. SURVEILLANCE SERVICE NOT AVAILABLE
5. ATS surveillance system ground equipment unavailability	a. SURVEILLANCE SYSTEM OUT OF SERVICE (or DEGRADED) (<i>appropriate information as necessary</i>)
6. To request the aircraft's SSR or ADS-B capability	a. ADVISE TRANSPONDER CAPABILITY b. ADVISE ADS-B CAPABILITY
7. To advise the aircraft's SSR or ADS-B capability	a. *TRANSPONDER (ALPHA, CHARLIE or SIERRA as shown in the flight plan) b. *ADS-B TRANSMITTER (TEN NINETY DATALINK) c. ADS-B RECEIVER (TEN NINETY DATALINK) d. *NEGATIVE TRANSPONDER

GEN 3.4

6.17.2 ATS Surveillance Service Communication and Navigation

Circumstances	Phraseologies * Denotes pilot transmission
<p>1. Communications</p> <p>if loss of communication is suspected</p>	<p>a. [IF] RADIO CONTACT LOST (<i>instructions</i>)</p> <p>b. IF NO TRANSMISSIONS RECEIVED FOR (<i>number</i>) MINUTES (<i>or SECONDS</i>) (<i>instructions</i>)</p> <p>c. REPLY NOT RECEIVED (<i>instructions</i>)</p> <p>d. IF YOU READ [<i>manoeuvre instructions or SQUAWK (code or IDENT)</i>]</p> <p>e. (<i>manoeuvre or SQUAWK</i>) OBSERVED, POSITION (<i>position of aircraft</i>), WILL CONTINUE TO PASS INSTRUCTIONS</p>
<p>2. Aircraft Directional Indicator Failure notify pilot of intention to use directional indicator failure procedures</p> <p>when suspected by ATC</p> <p>if heading response appears at variance with the track of the ATS Surveillance symbol</p> <p>turn instructions</p>	<p>a. ATS SURVEILLANCE SERVICE WILL CONTINUE, MAKE ALL TURNS RATE ONE (<i>or RATE HALF or (number) DEGREES PER SECOND</i>), EXECUTE INSTRUCTIONS IMMEDIATELY UPON RECEIPT</p> <p>b. CONFIRM HEADING</p> <p>c. SUSPECT YOUR DIRECTION INDICATOR HAS FAILED</p> <p>d. TURN LEFT (<i>or RIGHT</i>) NOW</p> <p>e. STOP TURN NOW</p>

6.17.3 ATS Surveillance System Manoeuvres

Circumstances	Phraseologies * Denotes pilot transmission
<p>1. General Manoeuvres</p> <p>when an ACFT is assigned a level below the MVA or MSA/LSALT</p> <p>when an ACFT is issued a heading instruction below the MVA or MSA/LSALT (Note: Where both heading and altitude instructions are issued, VISUAL need only be appended to the second part of the instruction.)</p>	<p>a. LEAVE (<i>significant point</i>) HEADING (<i>three digits</i>) [INBOUND] [AT (<i>time</i>)]</p> <p>b. CONTINUE HEADING (<i>three digits</i>)</p> <p>c. CONTINUE PRESENT HEADING</p> <p>d. FLY HEADING (<i>three digits</i>)</p> <p>e. TURN LEFT (<i>or RIGHT</i>) (<i>number</i>) DEGREES (<i>or HEADING (three digits)</i>) [<i>reason</i>]</p> <p>f. ORBIT LEFT (<i>or RIGHT</i>) [<i>reason</i>]</p> <p>g. CLIMB (<i>or DESCEND</i>) TO (<i>level</i>) VISUAL</p> <p>h. TURN LEFT (<i>or RIGHT</i>) (<i>number</i>) DEGREES (<i>or HEADING (three digits)</i>) [CLIMB (<i>or DESCEND</i>) TO (<i>level</i>)] VISUAL</p> <p>i. STOP TURN HEADING (<i>three digits</i>)</p>

Circumstances	Phraseologies * Denotes pilot transmission
<p>when instructing an aircraft to turn 180° or more and in order to emphasize the direction of turn</p> <p>when necessary to specify a reason for a manoeuvre, the following phraseologies should be used:</p>	<p>j. TURN LEFT (or RIGHT) - I SAY AGAIN - LEFT (or RIGHT) HEADING (<i>three digits</i>) [reason]</p> <p>(i) DUE TRAFFIC (ii) FOR SPACING (iii) FOR DELAY (iv) FOR DOWNWIND (or BASE, or FINAL)</p>
<p>2. Aircraft Vectoring by ATS Surveillance Service</p>	<p>a. *REQUEST VECTORS [TO (or FROM) (<i>aid, location or reason</i>)]</p> <p>b. DO YOU WANT VECTORS?</p>
<p>3. Transfer of Responsibility To transfer responsibility to the pilot for navigation on termination of vectoring</p>	<p>a. RESUME OWN NAVIGATION (<i>position of aircraft</i>) (<i>specific instructions</i>)</p>

6.17.4 Speed Control

Circumstances	Phraseologies * Denotes pilot transmission
<p>1. Speed</p> <p><i>Note: All speed communications shall relate to INDICATED AIRSPEED unless otherwise stipulated. Where applicable, Mach Number may be nominated as the basis of a speed statement.</i></p> <p>when an aircraft is required to increase to, or maintain, the maximum speed at which it can safely operate given the phase of flight.</p> <p>when an aircraft is required to reduce speed to the minimum possible in a clean configuration</p> <p>when an ATC-issued speed restriction no longer applies and the aircraft is on a published procedure for which a published speed currently applies.</p> <p>when ATC-issued speed restrictions no longer apply and the aircraft is required to resume the normal profile speed. Comply with airspace speed limitations. (<i>Note: Not used with SID or STAR instructions</i>).</p>	<p>a. *SPEED (<i>number</i>) KNOTS (or <i>Mach Number</i>)</p> <p>b. REPORT SPEED or ([CLIMB or CRUISE] MACH NUMBER)</p> <p>c. MAINTAIN (<i>number</i>) KNOTS (or MACH (<i>number</i>)) [OR GREATER (or LESS)] [UNTIL (<i>significant point</i>)]</p> <p>d. MAINTAIN PRESENT SPEED</p> <p>e. INCREASE (or REDUCE) SPEED TO (or BY) (<i>number</i>) KNOTS [OR GREATER (or LESS)]</p> <p>f. REDUCE TO MINIMUM APPROACH SPEED</p> <p>g. CROSS (<i>significant point</i>) [AT (<i>time</i>)] [OR LATER (or BEFORE)] [AT (<i>number</i>) KNOTS]</p> <p>h. INCREASE TO (or MAINTAIN) MAXIMUM SPEED [UNTIL (<i>significant point</i>)]</p> <p>i. REDUCE TO MINIMUM CLEAN SPEED</p> <p>j. RESUME PUBLISHED SPEED (or LEVEL RESTRICTIONS or SPEED AND LEVEL RESTRICTIONS)</p> <p>k. RESUME NORMAL SPEED</p>

Circumstances	Phraseologies * Denotes pilot transmission
<p>when aircraft speed is pilot's discretion. ATC speed restrictions are cancelled. Comply with airspace speed limitations. <i>(Note: Not used with SID or STAR instructions).</i></p> <p>when aircraft speed is pilot's discretion. All airspace and ATC speed restrictions are cancelled. <i>(Note: Not used with SID or STAR instructions).</i></p> <p><i>Note: Airspace speed limitations are at ENR 1.4 para 4.</i></p>	<p>l. NO ATC SPEED RESTRICTIONS</p> <p>m. NO SPEED RESTRICTIONS</p>

6.17.5 Traffic Information

Circumstances	Phraseologies * Denotes pilot transmission
<p>1. Traffic Information</p> <p>aircraft type to be passed if known</p>	<p>a. TRAFFIC <i>(number)</i> O'CLOCK <i>(distance)</i> <i>(direction of flight)</i> <i>[any other pertinent information]</i></p> <ul style="list-style-type: none"> (i) UNKNOWN (ii) SLOW MOVING (iii) FAST MOVING (iv) CLOSING (v) OPPOSITE <i>(or SAME)</i> DIRECTION (vi) OVERTAKING (vii) CROSSING LEFT TO RIGHT <i>(or RIGHT TO LEFT)</i> (viii) <i>(type)</i> (ix) <i>(level)</i> (x) CLIMBING <i>(or DESCENDING)</i> <p>b. CLEAR OF TRAFFIC <i>[appropriate instructions]</i></p>

6.17.6 Secondary Surveillance Radar (SSR) and ADS-B

<p style="text-align: center;">Circumstances</p>	<p style="text-align: center;">Phraseologies * Denotes pilot transmission</p>
<p>1. To Instruct Setting of Transponder (The word "code" is not used in transmissions.)</p> <p><u>to request:</u></p> <p>reselection of the assigned mode and code</p> <p>reselection of aircraft identification</p> <p>confirmation of Mode A Code selection</p> <p>operation of the IDENT feature</p> <p>temporary suspension of transponder operation <i>Note: ADS-B and SSR are linked in many aircraft and terminating one will terminate the other</i></p>	<p>a. SQUAWK (code) [IDENT if required]</p> <p>b. *[SQUAWK] (code) [AND IDENT if instructed by ATS]</p> <p>c. SQUAWK NORMAL</p> <p>d. RESET [(mode)] (code)</p> <p>e. *RESETTING [(mode)] (code)</p> <p>f. RE-ENTER MODE S (or ADS-B) AIRCRAFT IDENTIFICATION</p> <p>g. CONFIRM SQUAWK (code)</p> <p>h. *SQUAWKING (code)</p> <p>i. SQUAWK IDENT</p> <p>j. TRANSMIT ADS-B IDENT</p> <p>k. SQUAWK STANDBY [TRANSMIT ADS-B ONLY]</p>
<p>emergency code selection</p> <p>termination of SSR transponder or ADS-B transmitter operation <i>Note: ADS-B and SSR are linked in many aircraft and terminating one will terminate the other</i></p> <p>transmission of pressure altitude</p> <p>pressure setting check and confirmation of level</p> <p>termination of pressure altitude transmission because of faulty operation <i>Note: ADS-B and SSR are linked in many aircraft and terminating one will terminate the other</i></p> <p>altitude check</p> <p>confirmation of ADS-B operation</p> <p>change to secondary transponder</p>	<p>l. SQUAWK MAYDAY</p> <p>m. STOP SQUAWK [TRANSMIT ADS-B ONLY]</p> <p>n. STOP ADS-B TRANSMISSION [SQUAWK (code) ONLY]</p> <p>o. SQUAWK CHARLIE</p> <p>p. TRANSMIT ADS-B ALTITUDE</p> <p>q. CHECK ALTIMETER SETTING AND CONFIRM LEVEL</p> <p>r. STOP SQUAWK CHARLIE, WRONG INDICATION</p> <p>s. STOP ADS-B ALTITUDE TRANSMISSION [(WRONG INDICATION, or reason)]</p> <p>t. VERIFY LEVEL</p> <p>u. ADS-B TRANSMISSIONS NOT RECEIVED, CONFIRM ADS-B OPERATIONAL</p> <p>v. SELECT SECONDARY TRANSPONDER</p>
<p>2. Advice on Traffic Level Where the Pressure Altitude Derived Level Information Has Not Been Verified</p>	<p>a. UNVERIFIED LEVEL (level)</p>

6.17.7 General ADS-C Phraseologies

Circumstances	Phraseologies * Denotes pilot transmission
ADS-C Degradation	ADS-C (or ADS-CONTRACT) OUT OF SERVICE (appropriate information as necessary)

6.17.8 Approach Radar Services

Circumstances	Phraseologies * Denotes pilot transmission
<p>1. Vectoring for Approach</p> <p><i>Note: See ENR 1.1 para 2.11.2.5 for further approach phraseology information.</i></p>	<p>a. VECTORING FOR (type of approach) APPROACH [RUNWAY (number)]</p> <p>b. VECTORING FOR VISUAL APPROACH RUNWAY (number) REPORT FIELD (or RUNWAY) IN SIGHT</p> <p>c. VECTORING FOR (positioning in the circuit)</p> <p>d. (type of approach) APPROACH [RUNWAY (number)] NOT AVAILABLE DUE [reason] (alternative instructions)</p>
<p>2. Vectoring for ILS and other approach procedures</p> <p>instructions and information</p>	<p>a. POSITION (number) MILES FROM (fix), TURN LEFT (or RIGHT) HEADING (three digits)</p> <p>b. YOU WILL INTERCEPT (FINAL APPROACH COURSE or radio aid) (distance) FROM (significant point or TOUCHDOWN)</p> <p>c. *REQUEST (distance) FINAL</p> <p>d. CLEARED FOR (type of approach) APPROACH [RUNWAY (number)]</p> <p>e. REPORT ESTABLISHED ON LOCALISER (or ON [GLS/RNP] [FINAL] APPROACH [COURSE])</p> <p>f. CLOSING FROM LEFT (or RIGHT) [REPORT ESTABLISHED]</p> <p>g. TURN LEFT (or RIGHT) HEADING (three digits) [TO INTERCEPT] or [REPORT ESTABLISHED]</p> <p>h. EXPECT VECTOR ACROSS THE (LOCALISER or [GLS/RNP] FINAL APPROACH COURSE or radio aid) (reason)</p> <p>i. THIS TURN WILL TAKE YOU THROUGH THE (LOCALISER or [GLS/RNP] FINAL APPROACH COURSE or radio aid) (reason)</p> <p>j. TAKING YOU THROUGH THE (LOCALISER or [GLS/RNP] FINAL APPROACH COURSE or radio aid) (reason)</p>

Circumstances	Phraseologies * Denotes pilot transmission
	k. MAINTAIN (<i>level</i>) UNTIL GLIDE PATH INTERCEPTION l. REPORT ESTABLISHED ON THE GLIDE PATH m. INTERCEPT (LOCALISER <i>or</i> [GLS/RNP] [FINAL] APPROACH [COURSE] <i>or</i> radio aid) [RUNWAY (<i>number</i>)] [REPORT ESTABLISHED]
<p>3. Independent and Dependent Parallel Approaches</p> <p>Independent parallel approaches to confirm correct runway selection</p> <p>When aircraft will operate within 1NM of traffic on the adjacent final approach</p> <p>Independent Parallel Approaches when an aircraft is observed to be deviating towards the NTZ</p> <p>Break-out instruction issued when an aircraft penetrates, or is likely to penetrate, the NTZ</p>	a. CLEARED FOR (<i>type of approach</i>) APPROACH RUNWAY (<i>number</i>) LEFT (<i>or</i> RIGHT) b. YOU HAVE CROSSED THE LOCALISER (<i>or</i> GLS/RNP FINAL APPROACH COURSE). TURN LEFT (<i>or</i> RIGHT) IMMEDIATELY AND RETURN TO THE LOCALISER (<i>or</i> GLS/RNP FINAL APPROACH COURSE) RUNWAY (<i>number</i>) c. TURN LEFT (<i>or</i> RIGHT) HEADING (<i>three digits</i>) JOIN FINAL RUNWAY (<i>number</i>) FROM THAT HEADING CLEARED INDEPENDENT VISUAL APPROACH d. [EXPECT] ILS (<i>or</i> GLS) [RUNWAY (<i>number</i>) LEFT (<i>or</i> RIGHT),] IDENT IS (ILS <i>or</i> GLS <i>ident</i>) e. TRAFFIC (<i>aircraft type</i>) [RUNWAY LEFT (<i>or</i> RIGHT)] BEHIND (<i>or</i> AHEAD <i>or</i> ADJACENT) f. YOU ARE DEVIATING FROM THE FINAL APPROACH COURSE. TURN LEFT (<i>or</i> RIGHT) IMMEDIATELY AND RETURN TO YOUR CLEARED APPROACH g. BREAK-OUT ALERT, (<i>callsign</i>) TURN LEFT (<i>or</i> RIGHT) IMMEDIATELY HEADING (<i>three digits</i>) CLIMB (<i>or</i> DESCEND) TO (<i>level</i>)
<p>4. Position</p>	a. (<i>distance</i>) FROM TOUCHDOWN

6.17.9 Pilot Actions For Speechless Radar Approach

Circumstances	Phraseologies * Denotes pilot transmission
1. Pilot Request for Speechless Radar Approach When Microphone/s Unserviceable	a. *Pilot transmits four separate and distinct unmodulated transmissions of one second duration
2. Pilot Response to Subsequent Control Questions: (i) affirmative or acknowledgment (ii) negative (iii) say again	a. (i) *One distinct transmission b. (ii) *Two separate and distinct transmissions c. (iii) *Three separate and distinct transmissions
3. Pilot Indication of a Further and Pertinent Unserviceability or an Emergency	a. *Five separate continuous transmissions
4. Pilot Indication of Abandoning the Aircraft	a. *A single continuous transmission as long as practicable
5. Controller Requires Pilot to Indicate When an Instruction Has Been Completed	a. WHEN (condition or instruction is completed) MAKE A TWO SECOND TRANSMISSION

7. ATS DATA LINK SERVICES**7.1 General**

7.1.1 FANS-1/A data link services (CPDLC and ADS-C) are available within airspace controlled by Australian ATC within the Melbourne (YMMM), Brisbane (YBBB), Honiara (AGGG) and Nauru (ANAU) FIRs.

7.1.2 Pre-Departure Clearances (PDC) utilising FANS 1/A data link are not available within Australian administered airspace. (See *ENR 1.1 para 2.2.15*).

7.1.3 The data link procedures described herein are in accordance with international procedures. For more information concerning other data link procedures, refer to Chapter 5 of the *ICAO Global Operational Data Link Document (GOLD) Manual (Doc 10037)*.

7.1.4 FMC Waypoint Position Reporting (FMC WPR) is available within Oceanic airspace East of Australia for operators whose Air Operator's Certificate (AOC) supports the conversion of ACARS position reports into a suitable format (ARP) and the forwarding of these messages to ATC. Operators wishing to participate in FMC WPR should submit such a request to Airservices Australia.

7.2 Pilot Responsibilities

7.2.1 Participating flight crews must be trained in the use of data link equipment to a level approved by the State of Registry of the operator, and the aircraft must meet all State of Registry ATC data link requirements.

7.2.2 A logon request must be received from the aircraft before any data link connections can be initiated by the ground system. The initial logon request must be initiated by the flight crew in accordance with company and ATS procedures.

7.2.3 When using CPDLC for communications and/or ADS-C or FMC WPR for position reporting, flight crews must advise ATC when any fault occurs (e.g. loss of SATCOM) that may result in the degraded performance or non-availability of CPDLC, ADS-C and/or FMC WPR.

7.2.4 To ensure reliable Automatic Dependant Surveillance-Contract (ADS-C) is available, flight crews must ensure that the ADS-C application remains ARMED. Flight crews must also ensure that the ADS-C emergency mode has not been selected inadvertently.

7.2.5 CPDLC latency monitor functionality is used in Australian administered airspace.

7.2.5.1 If the aircraft is equipped with variable CPDLC latency monitor functionality, the pilot must, on receipt of the relevant message, enter the ATC specified latency time value into the aircraft avionics.

Note: Some avionics will automatically set the latency time value.

7.2.5.2 If the aircraft is not equipped with latency monitor functionality, or the functionality is not available, the pilot must still respond 'ROGER' and append the message 'TIMER NOT AVAILABLE'.

7.2.5.3 On receipt of a CPDLC indication that an uplink message has been delayed, the pilot must not act on the delayed uplink message and must seek clarification from ATC via voice.

Note: Some aircraft systems will discard the delayed message without indication to the flight crew and will automatically notify ATC of the network delay rejection.

7.2.5.4 When ATC receive an indication of a delayed uplink message, they will either:

- a. resend the delayed CPDLC message;
- b. contact the pilot via voice to clarify the situation; or
- c. instruct the pilot to disregard the CPDLC message, disconnect CPDLC and continue communication by voice.

7.2.5.5 When exiting Australian administered airspace, pilots should reset the latency time value as appropriate to their company procedure, location and aircraft system.

7.3 Controller Pilot Data Link Communication (CPDLC)

7.3.1 In controlled airspace beyond the range of VHF voice, CPDLC is the primary means of communications between ATC and flight crews operating FANS 1/A equipped aircraft. HF voice will be used as the backup communications medium. In Class G airspace HF is the primary means of communication, although controllers may initiate the use of CPDLC. The controller communicating by CPDLC holds responsibility for SAR and communications alerting.

7.3.2 In Australian continental airspace, VHF voice is normally the primary medium for communication. Within East Coast SSR Coverage flight crews should not initiate CPDLC messaging except:

- a. when transmitting position reports in accordance with paragraph 7.5.1; or
- b. when authorised by the controller; or
- c. in an emergency.

7.3.3 Outside East coast SSR coverage, ATC and pilots may use CPDLC to augment VHF communications.

7.3.4 Where CPDLC is to be used as the primary means of communications, flight crews will be instructed to transfer to CPDLC using the phraseology:

"TRANSFER TO (MELBOURNE/BRISBANE) CENTRE ON DATA LINK. MONITOR (frequency)."

7.3.5 CPDLC messages must be constructed using standard message elements, free text message elements or a combination of both. Standard message elements are contained in *PANS-ATM (DOC 4444)*, *Appendix 5* and *ICAO Doc 10037 - Global Operational Data Link (GOLD) Manual*.

7.3.6 When CPDLC is being used and the intent of the message is included in the CPDLC message set contained in *PANS-ATM (Doc 4444)*, *Appendix 5* or *ICAO Doc 10037 - Global Operational Data Link (GOLD) Manual*, the associated standard message elements must be used.

7.3.7 The use of free text message elements should be to a minimum. When the CPDLC message set contained in the *PANS-ATM (Doc 4444)* or *ICAO Doc 10037 - Global Operational Data Link (GOLD) Manual* does not provide for specific circumstances, the free text message elements may be used. These free text message elements should be sorted for selection within the aircraft system or ground system to facilitate their use.

7.3.8 To ensure the correct synchronisation of messages, dialogues initiated by voice must, wherever possible, be closed by voice. Dialogues initiated by CPDLC must be closed by CPDLC.

7.3.9 To avoid ambiguity, a CPDLC downlink message should not contain more than one clearance request.

7.3.10 If a CPDLC downlink message contains multiple clearance requests and not all of the requested clearances are available, the controller will respond with the uplink message UNABLE. The controller may subsequently uplink a separate CPDLC message containing any requested clearances that are available.

7.3.11 If any ambiguity exists as to the intent of a CPDLC message, clarification should be sought by voice.

7.3.12 A clearance issued by CPDLC requires only the appropriate CPDLC response, not a readback as would be required if the clearance had been delivered by voice.

7.3.13 The downlink response WILCO indicates that the flight crew has accepted the full terms of the entire uplink message including any clearance or instruction.

7.3.14 The downlink response UNABLE indicates that the flight crew is unable to accept the uplinked clearance or instruction. The flight crew must continue to operate in accordance with the most recently accepted clearance and/or instructions.

7.3.15 The use of the uplink STANDBY message element provides advice that the downlink request is being assessed and a short-term delay of less than 10 minutes can be expected until a response will be sent. The original message remains open.

7.3.16 The use of the uplink REQUEST DEFERRED message element provides advice that the downlink request is being assessed and a longer-term delay of greater than 10 minutes can be expected until a response will be sent. The original message remains open.

7.4 Logon Procedures

7.4.1 Before entering an airspace where data link applications are used by the ATS unit, data link communications shall be initiated between the aircraft and the ATS unit in order to register the aircraft and, when necessary, allow the start of a data link application. This shall be initiated by the aircraft, either automatically or by the pilot, or by the ATS unit on address forwarding.

Note: Provisions concerning the data link initiation capability (DLIC) are contained in Annex 10, Volume II, Chapter 8.

7.4.2 Brisbane ATC provides data link services in the Honiara and Nauru FIRs. The logon addresses for the appropriate FIRs are:

Brisbane	YBBB
Honiara	YBBB
Nauru	YBBB
Melbourne	YMMM

7.4.3 To avoid automatic rejection of the logon request:

- the aircraft identification and the aircraft registration contained in the logon request must be identical to the aircraft details filed in the flight plan; and
- aircraft departing from airports either within Australia (YBBB or YMMM FIR) or the AGGG and ANAU FIRs should not logon earlier than 45 minutes prior to the flight planned EOBT; and
- aircraft inbound to the YBBB, YMMM, AGGG or ANAU FIRs should not logon:
 - prior to departure; or
 - earlier than 45 minutes prior to the FIR boundary estimate.

7.4.4 Aircraft departing from airports either within Australia (YBBB or YMMM FIR) or the AGGG and ANAU FIRs, requesting data link services, should logon as described below:

- On the ground using the logon address for the FIR that the departure airport is located within; or
- Airborne at any time after passing 10000FT, using the logon address for the FIR in which the aircraft is currently operating, with the following exceptions:
 - Aircraft approaching a FIR boundary should logon to the next ATS unit, rather than the current ATS unit; and
 - Airborne aircraft departing Sydney/Bankstown/Richmond should logon in accordance with the following table:

Airborne aircraft departing Sydney/Bankstown/Richmond	
Departure track	Logon address
Airborne aircraft departing on tracks south of SY-OPTIC through west to SY-RI-MDG	YMMM
Airborne aircraft departing on tracks from SY-RI-MDG through east to SY-OPTIC (inclusive).	YBBB

Note: The above table applies to a logon from an airborne aircraft only. Flight crews who logon whilst on the ground at Sydney/Bankstown/Richmond must logon to YMMM.

7.4.5 When instructed to logon by voice, the flight crew must readback the logon address.

7.4.6 Unless otherwise instructed, aircraft remaining wholly within East Coast SSR Coverage are not required to logon for data link services.

7.4.7 Flight crews of operators participating in PDC at Australian airports must not initiate a logon until after the PDC has been received.

7.4.8 Aircraft requesting data link services on entering the AGGG, ANAU, YBBB or YMMM FIRs from a non-data link FIR should logon to the appropriate ATS unit between 15 and 45 minutes prior to crossing the FIR boundary. CPDLC and ADS-C connections will be established automatically by the ATS unit concerned.

7.4.9 For aircraft entering the AGGG, ANAU, YBBB or YMMM FIRs from a data link FIR, the CPDLC connection will be either transferred automatically by the Address Forwarding process, or the transferring ATS unit will instruct the flight crew to logon manually at an appropriate time/distance prior to the FIR boundary.

7.4.10 Aircraft transiting between the YBBB and YMMM FIRs will be automatically Address Forwarded to the appropriate ATS unit. Aircraft departing Australian airspace (or the AGGG and ANAU FIRs) and directly entering an adjoining data link FIR can expect to be Address Forwarded to the appropriate ATS unit prior to the FIR boundary.

7.5 Position Reporting Requirements

7.5.1 A CPDLC downlink is required to enable the controlling ATS unit to ensure that it is CPDLC data authority for the aircraft. To facilitate this, flight crews must send a single CPDLC position report either:

- a. whenever a new CPDLC Connection is established; or
- b. on entering the YMMM, YBBB, AGGG or ANAU FIR from another ATS unit; or
- c. crossing the YMMM/YBBB FIR boundary, except that aircraft inbound to land at Sydney/Bankstown/Richmond from the north or east are not required to downlink a CPDLC position report at the FIR boundary 45NM from SY.

7.5.2 Following this initial CPDLC position report, additional CPDLC or voice position reports are not required unless specifically requested by ATC. A CPDLC position report is not required when an aircraft is transferred from voice to CPDLC providing a report was downlinked earlier in accordance with [paragraph 7.5.1](#).

7.5.3 For non-identified aircraft, ADS-C reporting fulfils position reporting requirements. In the event of ADS-C failure, the pilot will be instructed to resume position reporting by either voice or CPDLC as appropriate.

7.6 CPDLC Level Reporting Following Change of Level

7.6.1 For non-identified aircraft, ADS-C reports fulfil level reporting requirements for a flight. Where ATC requires a CPDLC report, following or during a change of level, an appropriate instruction will be uplinked; e.g. "CLIMB TO AND MAINTAIN 370. REPORT LEVEL 370" or "REPORT LEAVING 350".

7.6.2 Upon receipt of this CPDLC uplink, flight crews must ensure that the correct downlink report is sent.

7.6.3 If no instruction to make a CPDLC report is received, the flight crew has no requirement to report either maintaining the assigned level, or leaving the previously assigned level.

7.7 Reporting Back on Route by CPDLC

7.7.1 If an aircraft is subject to a weather deviation and has been instructed to report back on route, the CPDLC BACK ON ROUTE message must not be downlinked until either:

- a. The aircraft has rejoined its previously cleared route; or
- b. The aircraft has requested and has been cleared direct to a subsequent waypoint and is proceeding directly to that waypoint.

7.7.2 If an aircraft is off track, but proceeding directly to a subsequent waypoint, the BACK ON ROUTE message must not be downlinked until after the aircraft has sequenced that waypoint.

Note: Downlinking BACK ON ROUTE before the aircraft is actually established on the cleared route may result in ATC applying incorrect separation tolerances to the aircraft.

7.8 Block Level Clearances

7.8.1 Subject to traffic, ATC may issue block level clearances to facilitate operations in adverse weather or to allow flight crews to optimise fuel burn for an aircraft.

7.8.2 A block level clearance is cancelled or amended by the issuing of a new vertical clearance.

7.8.3 To request a cancellation of a block clearance when it is no longer required, flight crews should downlink a CPDLC request for the preferred level in order to enable ATC to issue the new vertical clearance.

7.9 Revision of Estimates Using CPDLC

7.9.1 Under normal circumstances, an aircraft position reporting via ADS-C is not required to advise ATC of any revised waypoint estimates. Exceptions are:

- a. revisions of greater than two (2) minutes to a previous flight crew advised estimate (i.e., by voice or CPDLC); or
- b. following a flight crew initiated action (e.g. speed change) resulting in an amended estimate of greater than two (2) minutes.

7.9.2 If required, flight crews shall advise a revised estimate by one of the following methods:

- a. by voice report; or
- b. a CPDLC position report containing the revised estimate; or
- c. the CPDLC free text message element, "REVISED ETA [position] [time]".

7.10 CPDLC Message Restrictions

7.10.1 Controllers will not issue uplink instructions relating to cruise climbs, or the message element "CRUISE (altitude)". Additionally controllers will not issue uplink instructions containing the "AT PILOT DISCRETION" message element.

7.11 CPDLC CONTACT and MONITOR messages

7.11.1 The format of the [frequency] variable in the CPDLC "CONTACT" and "MONITOR" message elements permits the inclusion of only a single frequency. Due to this limitation, only the primary frequency will be notified to flight crews. The secondary frequency - uplinked as a free text - will be available on request.

7.11.2 The format of the [unit name] variable in the CPDLC "CONTACT" and "MONITOR" message elements does not support the ATS unit "RADIO". Due to this limitation, "CENTRE" will be used (i.e. "CONTACT BRISBANE CENTRE 13261", rather than "CONTACT BRISBANE RADIO 13261").

7.12 CPDLC route clearances

7.12.1 On occasions, controllers may issue amended route clearances by CPDLC in order to optimise an aircraft's route, or to separate with either traffic or restricted airspace. Operators must ensure that flight crews are familiar with the functionality associated with the display and loading of CPDLC route clearances.

7.13 CPDLC Failure

7.13.1 Flight crews becoming aware of a CPDLC connection failure when CPDLC is being used as the primary means of communication must immediately re-establish primary communications on the appropriate voice frequency.

7.13.2 In the event of either a programmed or unexpected CPDLC shutdown, ATC will advise all data link connected aircraft to re-establish primary communications by voice. The return of the system to an operational state may require a new logon from affected aircraft. Voice will continue to be used as the primary means of communication until CPDLC connections are re-established and ATC has authorised a return to data link communications.

7.14 Notification Of Emergency

7.14.1 Depending on the nature of the emergency condition experienced, flight crews should notify ATC of the circumstances by the most efficient means (voice, CPDLC or ADS-C).

7.14.2 If a CPDLC MAYDAY or PAN message is received by the ATS unit, ATC will respond with the free text uplink message ROGER MAYDAY (or ROGER PAN). ATC will not expect a ROGER response to the uplink until being notified that the emergency situation has been cancelled or stabilised to the extent that messages are able to continue being exchanged (if CPDLC is considered to be the best communications medium for the situation).

7.14.3 ATC may respond via CPDLC to a report indicating unlawful interference with the uplink message ROGER 7500.

7.14.4 If an ADS-C report containing emergency mode is received by the ground system without voice or CPDLC confirmation of an emergency situation, ATC will check for inadvertent activation of emergency mode by voice or CPDLC using the phraseology "CONFIRM ADS-C EMERGENCY".

- a. If the emergency mode has been inadvertently activated, the flight crew must respond by voice or CPDLC using the phraseology "ADS-C RESET" and cancel the ADS-C emergency mode.
- b. ATC will assume an emergency situation exists if there is no confirmation that the activation of emergency mode was inadvertent and ADS-C emergency reports are still being received.

7.14.5 When an emergency situation no longer exists, the flight crew should cancel the ADS-C emergency mode (if activated).

7.14.6 Standard message elements are listed in *ICAO Doc 10037 - Global Operational data Link (GOLD) Manual*.

7.14.7 The following table contains CPDLC free text message elements used in Australia.

7.15 CPDLC Message Set

Uplinks - Free text message elements

MESSAGE ELEMENT	MESSAGE INTENT	RESPONSE
SET MAX UPLINK DELAY TO [sss] SEC	Instruction to set the CPDLC Latency Monitor time value to the value provided.	R
REPORT DISTANCE (to/from) (position)	Instruction to report the present distance to or from the specified position.	NE
CONFIRM POSITION	Instruction to report the present position.	NE
CONFIRM ALTITUDE	Instruction to report the present level.	NE
CONFIRM TIME OVER REPORTED WAYPOINT	Instruction to confirm the previously reported time over the last reported waypoint.	NE
CONFIRM REPORTED WAYPOINT	Instruction to confirm the identity of the previously reported waypoint.	NE
CONFIRM NEXT WAYPOINT	Instruction to confirm the identity of the next waypoint.	NE
CONFIRM NEXT WAYPOINT ETA	Instruction to confirm the previously reported estimated time at the next waypoint.	NE
CONFIRM HEADING	Instruction to report the present heading.	NE
IDENTIFICATION TERMINATED	ATS advisory that the radar and/or ADS-B service is terminated.	R
CONFIRM ADS-C ARMED	Instruction for the flight crew to check that the ADS-C function is armed.	R
ADVISE PREFERRED LEVEL TO CROSS [position]	Instruction to advise the preferred flight level at the specified position for the flight.	R
REPORT ETA [position]	Instruction to report the estimated time of arrival at the specified position.	R
ADS-C INDICATES OFF ROUTE. ADVISE INTENTIONS	Instruction to notify of receipt of any ADS-C report indicating a deviation from cleared route and to request the flight crew to advise of intentions.	
ADS-C INDICATES ROUTE NONCONFORMANCE. ADVISE INTENTIONS	Instruction to notify of receipt of any ADS-C report indicating a future deviation from cleared route and to request the flight crew to advise of intentions.	R
ADS-C ESTIMATES APPEAR INACCURATE. CHECK FMS	Instruction to notify of receipt of any ADS-C report that appears to contain inaccurate time estimates and to request the flight crew to check FMS.	R
CHECK AND RESPOND TO OPEN CPDLC MESSAGES	Instruction to check the status of CPDLC messages and to respond to unanswered uplink messages.	R
EXPECT SELCAL CHECK HF [frequency]	Notification that a SELCAL check on the specified HF frequency should be expected.	R
EXPECT CPDLC TRANSFER AT [time]	Notification that the CPDLC transfer process will not be completed at the FIR boundary and will be delayed until the specified time. If the CPDLC transfer is not completed by the specified time, the flight crew should manually disconnect and logon to the next centre.	R

Uplinks - Free text message elements

MESSAGE ELEMENT	MESSAGE INTENT	RESPONSE
EXPECT NEXT CENTRE [facility designation]. CONTACT WITH [facility designation] NOT REQUIRED	Notification that a CPDLC connection is not required by the next FIR (e.g. due to short transition time of the next FIR) and CPDLC connection will be transferred to the subsequent FIR.	R
REQUEST RECEIVED RESPONSE WILL BE VIA VOICE	Notification that the CPDLC downlink request was received by the controller and that any further communication about the request will be via voice.	R
ADS-C INDICATES LEVEL DEVIATION. ADVISE INTENTIONS	Instruction to notify of receipt of any ADS-C report indication a deviation from cleared level and to request the flight crew to advise of intentions.	R
REACH [level] BY [time]	Instruction that a change of level is to continue, but at a rate such that the specified level is reached at or before the specified time.	R
REACH [level] BY [position]	Instruction that a change of level is to continue, but at a rate such that the specified level is reached at or before the specified position.	R
LEAVE CONTROL AREA DESCENDING	Instruction to leave controlled airspace on descent.	R
CRUISE CLIMB PROCEDURE NOT AVAILABLE IN AUSTRALIAN ADMINISTRED AIRSPACE	Response to a request for a cruise climb. This procedure is not available.	R
IDENTIFIED	ATS advisory that the aircraft has been identified on radar and/or ADS-B.	R
REACH [level] BY [distance] NM [before/ after] [position]	Instruction that a change of level is to continue, but at a rate such that the specified level is reached at or before the specified distance before or after the specified position.	R
MELBOURNE [or BRISBANE] CENTRE AT REDUCED SYSTEM CAPACITY. DISCONNECT CPDLC	Notification that the specified ATS Unit is operating at reduced capacity.	R
RE-ENTER ADS-B IDENTIFICATION [flight identification]	<i>Instruction to check and to re-enter the correct ADS-C flight identification for the flight.</i>	R
ADS-C REPORTS NOT RECEIVED. REQUEST CPDLC POSITION REPORTS	<i>Notification that ADS-C reports are not being received from a flight and that the flight crew is to report position using CPDLC position reports.</i>	R
DO NOT DISCONNECT CPDLC. LOGON TO [unit name]	Instruction to logon to the specified ATS Unit without disconnecting CPDLC.	R
DISCONNECT CPDLC	Instruction to disconnect CPDLC.	R

APPENDIX 1. AUSTRALIAN AFTN CIRCUITRY

NATIONAL COMMUNICATIONS CENTRE MELBOURNE - YMML YFYX

ATS UNITS IN AUSTRALIA

Adelaide ACC/FIC	YPAD
Albury	YMAY
Alice Springs	YBAS
Archerfield	YBAF
Avalon	YMAV
Bankstown	YSBK
Brisbane FIR	YBBB
Brisbane	YBBN
Broome	YBRM
Cairns	YBCS
Camden	YSCN
Canberra	YSCB
Christmas Island =	YPXM
Coffs Harbour	YCFS
Darwin*	YPDN
Essendon	YMEN
Gold Coast	YBCG
Hamilton Island	YBHM
Head Office	YSHO
Hobart	YMHB
Jandakot	YPJT
Karratha	YPKA
Launceston	YMLT
Mackay	YBMK
Melbourne FIR	YMMM
Melbourne * COMC/BOF/NOF	YMML
Moorabbin	YMMB
Parafield	YPPF
Perth	YPPH
Port Hedland	YPPD
Rockhampton	YBRK
Sunshine Coast	YBSU
Sydney	YSSY
Tamworth	YSTW
Townsville*	YBTL
Woomera	YPWR

EXTERNAL ORGANISATIONS

Australian Maritime Safety Authority (AMSA)	YSMO
Joint Rescue Coordination Centre (JRCC)	YSARYCYX
Australian Transport Safety Bureau (ATSB) =	(see Note 2)
Civil Aviation Safety Authority (CASA)	YSCA
Customs	YSCBCUST
Darwin District Airport Inspector	YPDNYDYX
Bureau of Meteorology (MET)	YMMC
Airline Company Network (SITA)	WSSSITX

INTERNATIONAL CENTRES

Fiji - Nadi	NFFN
Indonesia - Jakarta	WIII
Johannesburg	FAJS
Nauru Is - Nauru	ANAU
New Guinea - Port Moresby	AYPY
New Zealand - Christchurch	NZCH
Singapore Is - Singapore	WSSS
Solomon Islands - Honiara	AGGH
USA - Salt Lake City	KSLC
Vanuatu - Port Vila	NVVV

MILITARY UNITS

AIS-AF	YMMXYOYX
Amberley	YAMB
East Sale	YMES
Edinburgh	YPED
Nowra	YSNW
Oakey	YBOK
Pearce	YPEA
Richmond	YSRI
Tindal*	YPTN
Williamstown*	YWLM

AIRLINE COMPANIES

Japan Airlines	YBCSJALX
Qantas Airlines	YSSYQFAO
United Airlines	YSSYUALO
Virgin Australia	YBBBVOZX

LEGEND

- * Military/civil use
- = Fax connection

Note 1: There are many supplementary inter-unit AFTN circuits available which are not included.

Note 2: Messages for the ATSB should be directed by FAX: +61 2 6274 6434

APPENDIX. 2 MARSHALLING SIGNALS

1. INTRODUCTION

1.1 The signals to an aircraft on movement areas are designed for use by the marshaller facing the aircraft in a position:

- a. for fixed wing aircraft, forward of the left wing tip within view of the aircraft captain.
- b. for night operations the wands should not be too bright and used in pairs of the same colour.

1.2 The signals listed in this section may be used by the aircraft captain as appropriate, using the signals in a similar way to those indicated.

Note: Day signals are shown on the left of the diagrams; night signals are shown on the right.

2. GENERAL

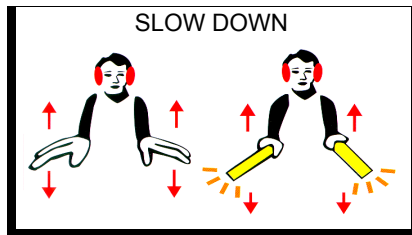
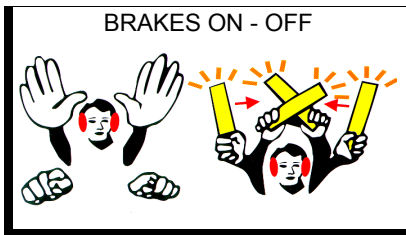
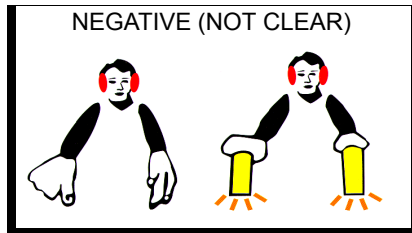
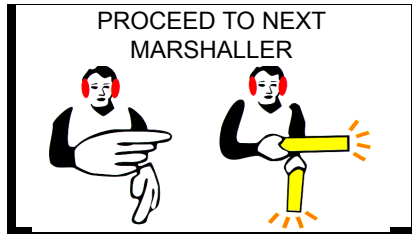
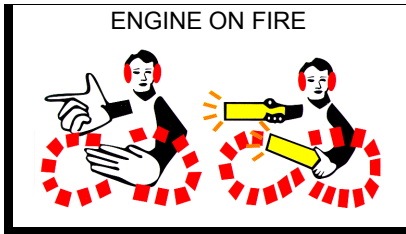

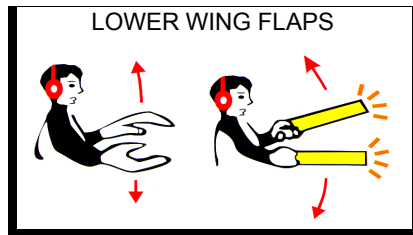
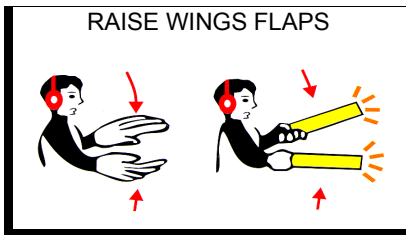
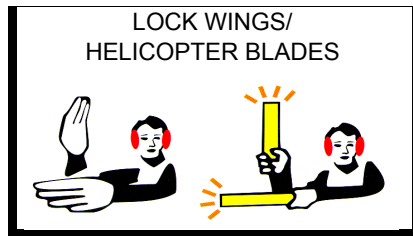
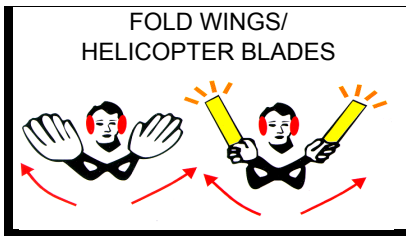
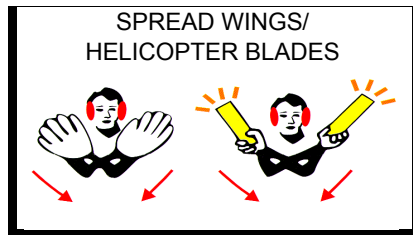
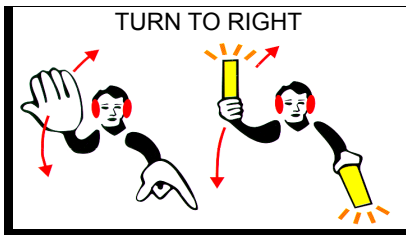
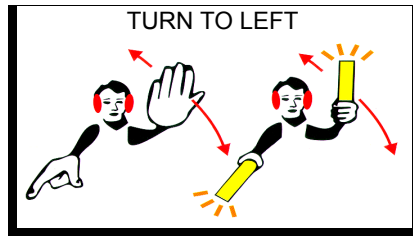
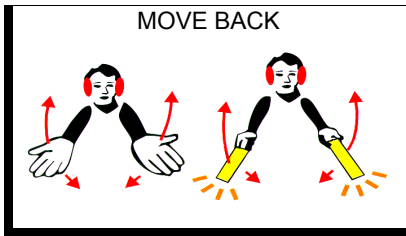
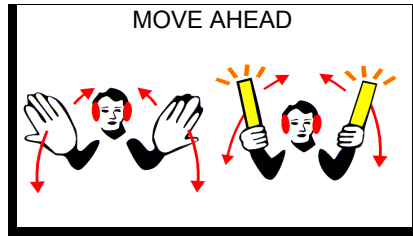
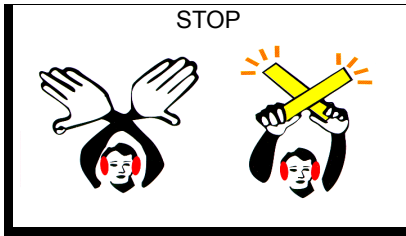

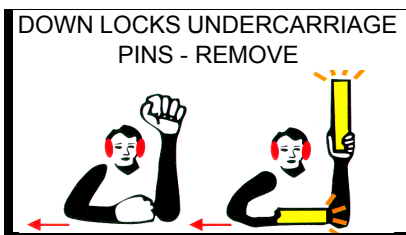
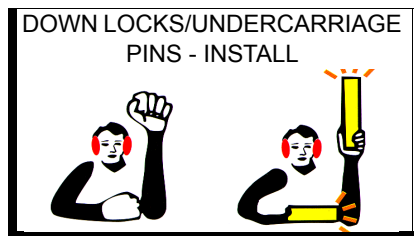
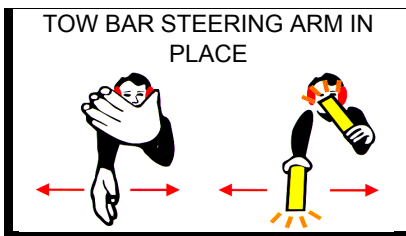
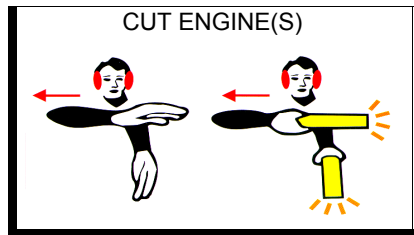
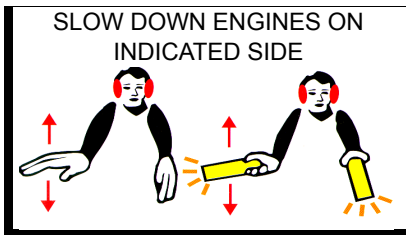
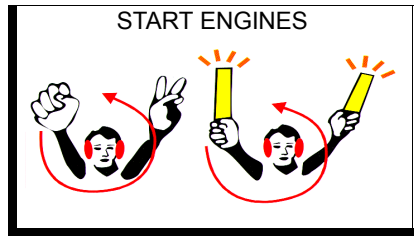
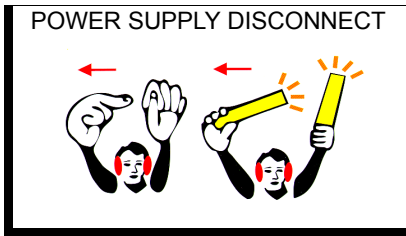
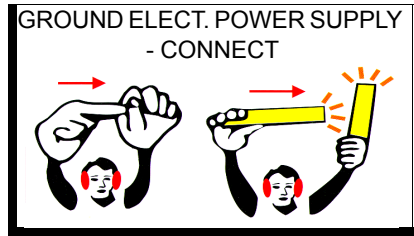
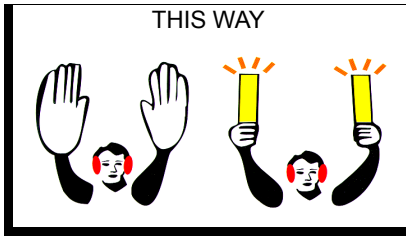

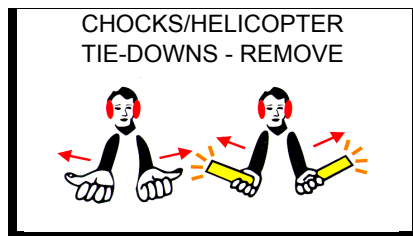
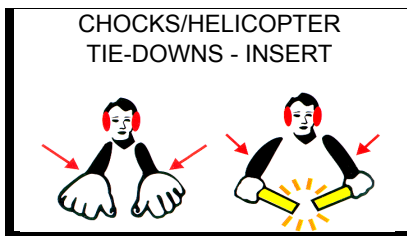
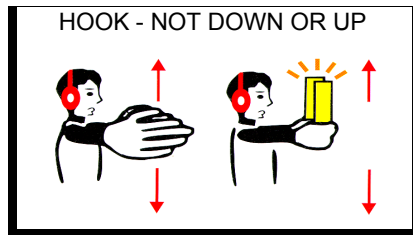
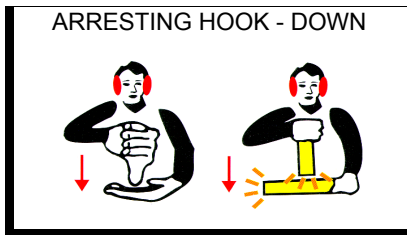
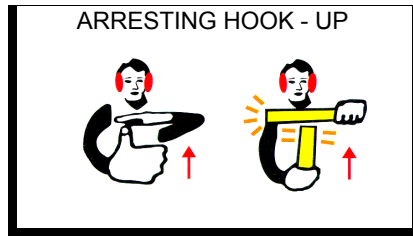
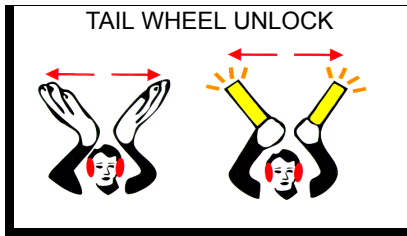
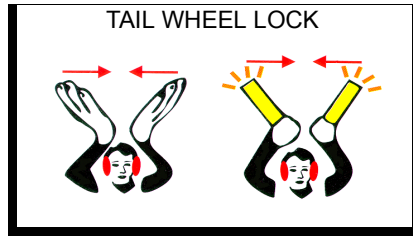
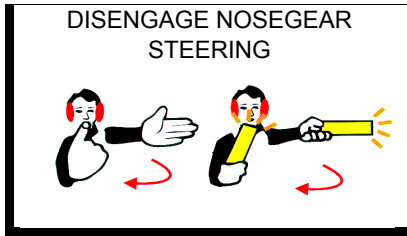

GEN 3.4

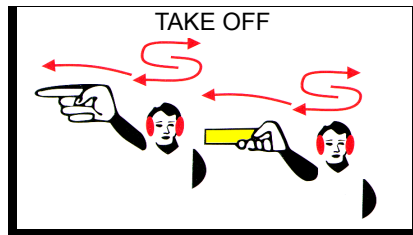
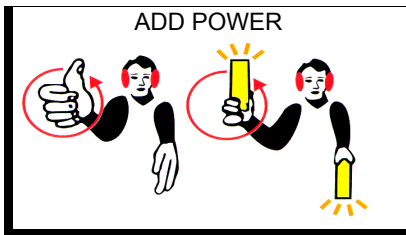
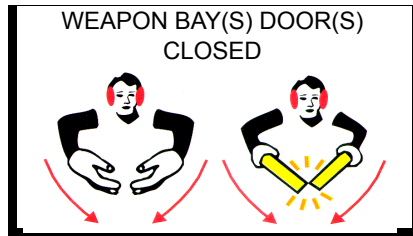
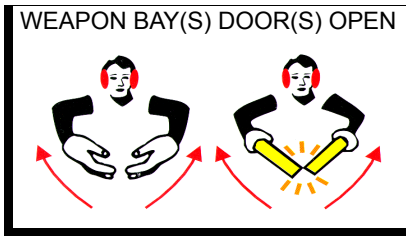
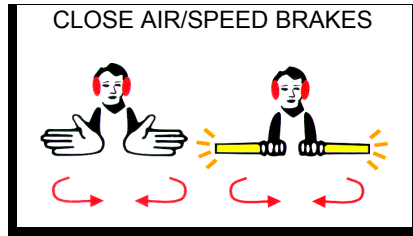
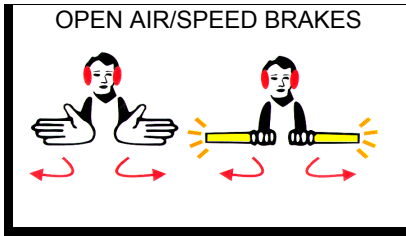

DAY - Normal finger wind up.
NIGHT - One wand wind up.

3. CABLE OPERATIONS



DAY - Hands held at 11 o'clock and 1 o'clock.
 NIGHT - Same, holding wands.

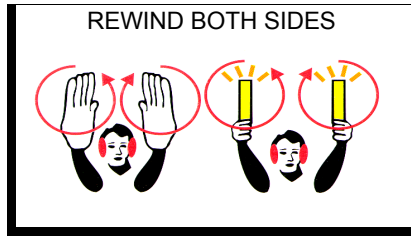

DAY - Indicated by vertical movements of arms.
 NIGHT - Same, holding wands.

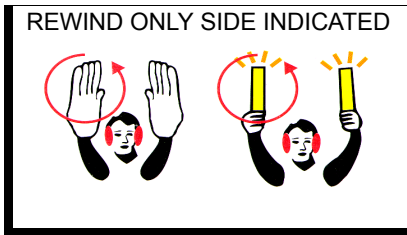

4. ROTARY WING AND VTOL AIRCRAFT

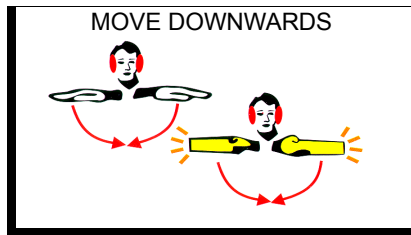
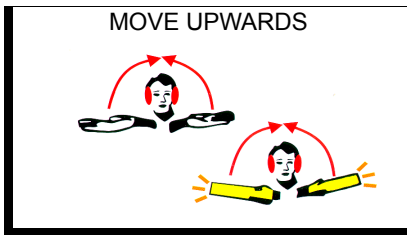
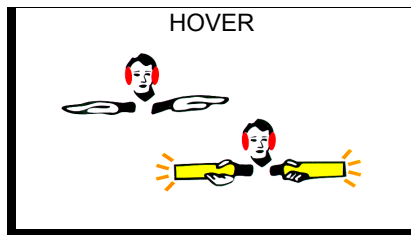
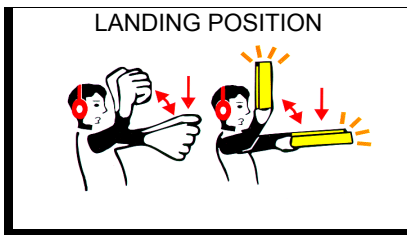

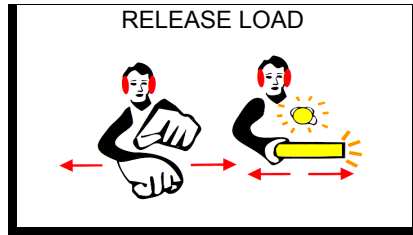
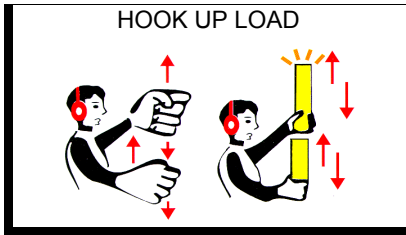
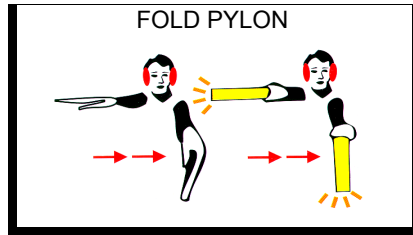
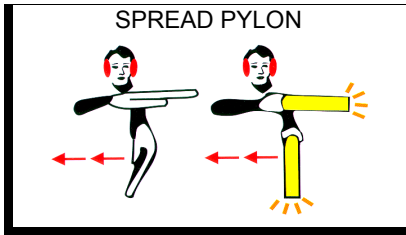
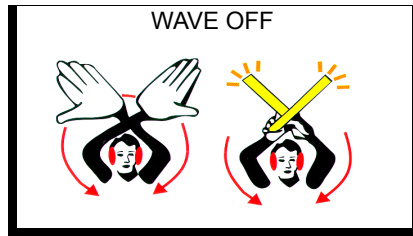
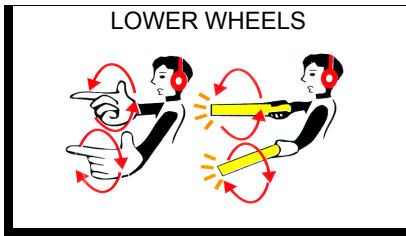
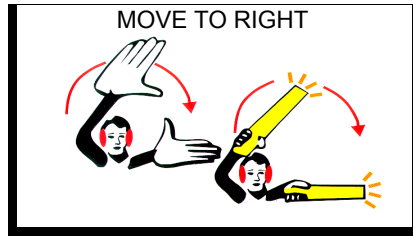
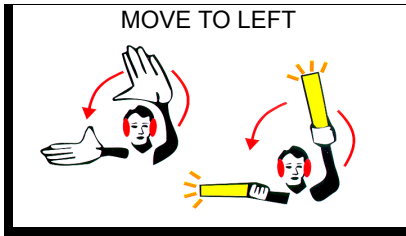

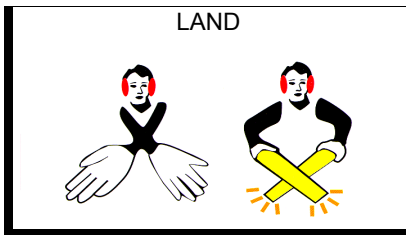
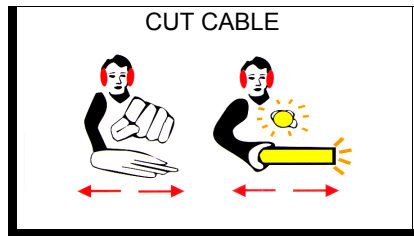
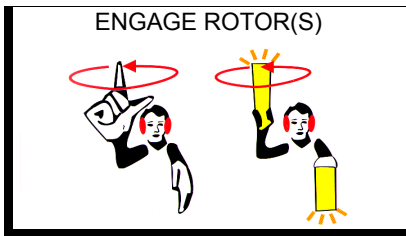
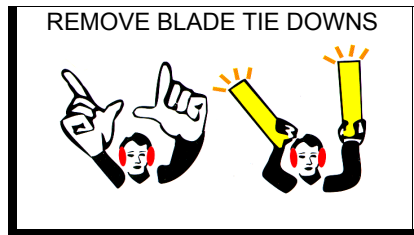
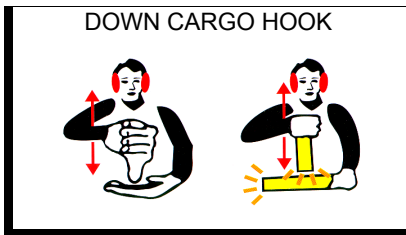
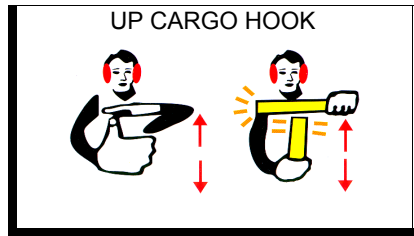
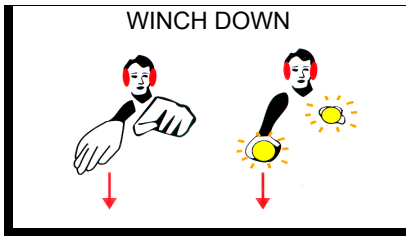
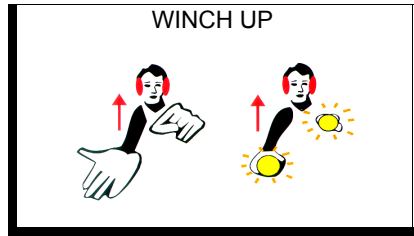

GEN 3.5 METEOROLOGICAL SERVICES

1. ADF - METEOROLOGICAL AUTHORITY

1.1 The Australian Bureau of Meteorology (BoM) is responsible for the provision of meteorological services within the Australian FIR and external Australian territories. Under the authority of the Meteorology Act (1955) it provides meteorological services for the ADF generally, including services for military aviation in Australia and its Territories. BoM supports and works cooperatively with the RAN METOC Services which provides meteorological and oceanographic services to support ADF maritime activities.

- a. **Meteorological Authority Office**
Australian Bureau of Meteorology
GPO Box 1289, MELBOURNE VIC 3001
PHONE: +61 3 9669 4000
FAX: +61 3 9669 4699
Email: metauthority@bom.gov.au
- b. **RAN METOC Services**
Director of Oceanography and Meteorology
Maritime Headquarters
Wyld Street, POTTS POINT, NSW 2011
PHONE: +61 2 9359 3140
FAX: +61 2 9359 3120

RAN - RAN METOC Services is responsible for military aviation forecasts for aircrew of the RAN while at sea and military aircrew operating out of HMAS Albatross.

1.2 **Applicable ICAO Documents.** The meteorological service is provided in accordance with provisions in the following ICAO documents:

- Annex 3 – Meteorological Service for International Air Navigation
- Doc 7030 – Regional Supplementary Procedures
- Doc 8400 – PANS – ICAO Abbreviations and Codes
- Doc 8896 – Manual of Aeronautical Meteorological Practice
- Doc 9673 – Air Navigation Plan Asia and Pacific Regions
- Doc 10100 – Manual on Space Weather Information in Support of International Air Navigation
- Annex 11: Air Traffic Services (MET related issues only)
- Annex 12: Search and Rescue (MET related issues only)
- Annex 15: Aeronautical Information Services (MET related issues only)

Differences from Annex 3, "Meteorological Service for International Air Navigation," are listed in GEN 1.7,

1.3 **Resources.** BoM publishes online resources regarding aviation weather at www.bom.gov.au/aviation/.

2. AREA OF RESPONSIBILITY.

2.1 The area of responsibility for the provision of aeronautical meteorological services set out in this publication covers the Australian FIR and Australian external territories in other FIR. An aeronautical meteorological watch service is provided to issue SIGMET for the Australian FIR. Refer to the BoM Aviation Knowledge Centre for more information: www.bom.gov.au/aviation/knowledge-centre/.

3. METEOROLOGICAL OBSERVATIONS AND REPORTS

Details about services available at individual aerodromes are available in *ERSA FAC*. There is also some information provided by BoM online: www.bom.gov.au/aviation/location-info/.

3.1 **METAR/SPECI**. More information on METAR/SPECI can be found in the Product Information section of the BoM Aviation Knowledge Centre: www.bom.gov.au/aviation/knowledge-centre/.

3.1.1 **Routine Reports (METAR)**. METAR is a routine report of meteorological conditions at an aerodrome. METAR are normally issued on the hour and half hour.

3.1.2 **Special Reports (SPECI)**. SPECI are non-routine aerodrome reports issued whenever one or more observed meteorological elements meet specified criteria significant to aviation.

3.2 **Other Meteorological reports**. On request other Meteorological reports may be provided based on the whole horizon or only the area that will contain the probable flight path of an aircraft. Other Meteorological reports are provided by:

- a. Tower ATC at controlled aerodromes; or
- b. A CA/GRS or UNICOM at certain non-controlled aerodromes.

4. TYPES OF SERVICES

BoM provides an English language H24 service from the Brisbane MET Office (MO) and Melbourne MO. The Melbourne MET Watch Office (MWO) is operated by the Melbourne MO and the BoM Hazardous Weather Unit (HWU). The Brisbane MWO is operated by the Brisbane MO and BoM HWU. Australia also operates a Volcanic Ash Advisory Centre and Tropical Cyclone Advisory Centre. The following services are available from/for Australia:

- a. Forecast upper-level wind and temperature charts;
- b. Satellite imagery;
- c. Significant weather charts;
- d. Route forecasts (wind and temperature);
- e. Grid Point forecasts (wind and temperature);
- f. OPMET (TAF, METAR/SPECI, Aerodrome Warning, Wind Shear Warning, Wind Shear Alert, Microburst Alert, SIGMET, AIRMET, GAF, VA Advisory, TC Advisory and SWX Advisory);
- g. Aerodrome weather briefing; and
- h. Area QNH.

For more information of these products, refer to the BoM aviation website: www.bom.gov.au/aviation/.

ADF - Information specifically packaged for ADF users is available under a Defence Registered User page. Login and password for this service are available through DMSU or any Defence MO.

A consultative briefing service is available from both MO. Local numbers align with the 10 areas as detailed on the PCA and are given in the following table:

QLD-North	☎ +61 7 3239 8721
QLD-South	☎ +61 7 3239 1854
NT	☎ +61 8 8920 3814
WA-North	☎ +61 8 9263 2259
WA-South	☎ +61 8 9263 2255
NSW-East	☎ +61 2 9296 1526
NSW-West	☎ +61 2 9296 1527
VIC	☎ +61 3 9669 4850
TAS	☎ +61 3 6221 2026
SA	☎ +61 8 8366 2773

Note: Conversations on these briefing services are recorded.

Meteorological information is available by phone and electronic briefing systems from the NOMC Pilot Briefing Office, located in Canberra. Contact details are:

Airservices Pilot Briefing Office
 GPO Box 367
 CANBERRA ACT 2601
 PH: +61 2 6268 5062
 Fax: +61 2 6268 5033

ADF - A meteorological briefing service for military users is available from the Defence Meteorological Support Unit (DMSU). Forecaster support is available 24HR/7 days.

☎ +1800 203 860 or Manager Ops ☎ + 61 2 6262 7316.

4.1 ATS Meteorological Information Service

4.1.1 The ATS meteorological information service is contained within the Flight Information Service (FIS) described in *GEN 3.3 Section 3.3*.

4.1.2 **Defence Meteorological Support Unit (DMSU)**. The central point of contact in the BoM for the provision of meteorological services to the ADF is DMSU at Headquarters Joint Operations Command (HQJOC) Bungendore (NSW). It coordinates forecast requirements and provides strategic weather watch for Australia, South-east Asia and the South-west Pacific. The DMSU is staffed 7 days a week 24 hours a day.

- a. **DMSU**
- Operations: 1800 203 860 or 02 6262 7316
 - Manager: +61 2 6128 4355
 - FAX: +61 2 6128 4307
 - E-mail: dmsu@bom.gov.au

4.1.3 **Defence Meteorological Office (Defence MO).** Defence MOs provide forecasts and warnings for at least the local aerodrome. They also supply and display meteorological information and provide briefing and documentation for military aircrew. Defence MOs complement the broader role of the DMSU, providing a local meteorological service outlet at selected locations where aircraft type, operations and climate warrant such a service. Defence MOs are located at:

- a. RAAF Base Amberley, ☎ +61 7 3281 4656
- b. RAAF Base East Sale, ☎ +61 3 5144 2381
- c. RAAF Base Pearce, ☎ +61 8 9571 7126
- d. RAAF Base Tindal, ☎ +61 8 8973 6249
- e. RAAF Base Townsville (joint civil and military function) ☎ +61 7 4752 1215
- f. RAAF Base Williamtown, ☎ +61 2 4964 6500
- g. Oakey Army Aviation Centre, and ☎ +61 7 4691 1444
- h. Canberra Meteorological Office (joint civil and military function).

4.1.4 **RAN - Fleet Weather and Oceanographic Centre (FWOC).** RAN METOC Services provides meteorological and oceanographic services primarily to the RAN through FWOC located at Maritime Headquarters. Localised services to military aircrew are provided through the Naval Air Station Weather and Oceanographic Centre (NWOC) at HMAS Albatross, Nowra, for an area extending 51NM from Nowra and the sea area including areas R495 and R453.

- a. **FWOC**
Duty Forecaster
Level 1, Maritime Headquarters
Wylde Street
POTTS POINT, NSW 2011
☎ +61 2 9359 4130
FAX: +61 2 9359 4182
- b. **NWOC (HMAS Albatross)**
Duty Forecaster
Air Traffic Control Facility
HMAS Albatross
NOWRA, NSW 2540
☎ +61 2 4424 1269
FAX: +61 2 4424 1159

4.2 Interpretation and Use of Forecasts

4.2.1 In TAF, cloud heights are given above the aerodrome elevations. In other forecasts, heights are expressed:

- a. as a flight level; or
- b. with reference to mean sea level.

4.3 Forecasts for Operations Above 10,000FT

4.3.1 The meteorological information for operations above 10,000FT will consist of the following as appropriate:

- a. Significant Weather Charts:
- b. Wind and Temperature Charts:
- c. Grid Point Forecasts (wind and temperature):
- d. Route Sector Winds and Temperatures

4.3.2 This information is available from:

- ATS automated briefing systems: NAIPS-AVFAX or charts;
- ATS briefing offices by phone or fax; and
- BoM.

4.4 Significant Weather (SIGWX) Charts

4.4.1 The significant weather expected in the airspace from FL250 to FL630 (SIGWX High) and FL100 to FL250 (SIGWX Medium) are depicted on the relevant chart using approved symbols and abbreviations. Significant features of the surface synoptic situation may also be shown.

4.4.2 More information on SIGWX Charts can be found in the Product Information section of the BoM Aviation Knowledge Centre: www.bom.gov.au/aviation/knowledge-centre/.

4.4.3 Significant weather charts are available from NAIPS (under Charts) and from the BoM aviation web page.

4.5 Route Sector Winds and Temperatures (RSWT)

4.5.1 RSWT forecasts are provided for various sectors of frequently used domestic air routes. Some longer routes may be sub-divided into segments, e.g: YPAD/YPOD/YMHB.

4.5.2 More information on RSWT forecasts can be found in the Product Information section of BoM Aviation Knowledge Centre: www.bom.gov.au/aviation/knowledge-centre/.

4.5.3 RSWT forecasts are available from NAIPS (under Charts) and from BoM aviation web page.

4.6 Grid Point Wind and Temperature (GPWT) Forecasts

4.6.1 GPWT charts provide a display of wind and temperature data derived from weather model data.

4.6.2 More information on GPWT forecasts can be found in the Product Information section of BoM Aviation Knowledge Centre: www.bom.gov.au/aviation/knowledge-centre/.

4.6.3 Low-level GPWT Reference Charts with PCA points can be found in the NAIPS Charts Directory.

4.7 Graphical Area Forecasts (GAF) for Operations At or Below 10,000FT

4.7.1 GAF are issued for aircraft operations at or below 10,000FT for the 10 areas as detailed on the PCA. They comprise of an image and supporting text detailing the meteorological conditions. GAF are prepared and issued at the following times (UTC):

- a. 6 hour validity periods 2300 to 0500, 0500 to 1100, 1100 to 1700 and 1700 to 2300;
- b. At each issue time two GAF will be issued covering a 12 hour period, for example at 2200, both 2300 to 0500 and 0500 to 1100 GAF will be issued;
- c. GAF will be issued no later than 30MIN before the commencement of the validity period of the first GAF;
- d. the issuance of a new GAF replaces the previously issued GAF for the same validity period.

4.7.2 Forecasts for critical locations are included in some GAF. These include:

- Bowral (BWL - NSW-E);
- Mt Victoria (MVI - NSW-E);
- Murrurundi (MUI - NSW-E); and
- Kilmore Gap (KMG - VIC).

4.7.3 Aerodrome Weather Reports (AWR), i.e. METAR/SPECI and AWIS, are only available for MUI and KMG. However, AWR from Moss Vale (MSV) and Mount Boyce (MTB) typically provide representative observations from BWL and MVI respectively.

4.7.4 GAF are available from the ATS automated briefing systems and briefing offices.

4.7.5 More information on GAF can be found in the Product Information section of BoM Aviation Knowledge Centre: www.bom.gov.au/aviation/knowledge-centre/.

4.7.6 A Flight Forecast (text based forecasts) may be issued for any part of a flight for which a routine GAF is not prepared - requests are to be made to the relevant MO.

4.8 Aerodrome Forecasts (TAF)

4.8.1 TAF are a statement of meteorological conditions expected for a specified period in the airspace within a radius of 8KM of the ARP.

4.8.2 TAF service is typically provided in accordance with the aerodrome's TAF category, as follows:

Category	Aerodrome Type	TAF Service
TAF3	Selected aerodromes specified in <i>ERSA</i>	Issued 3 hourly. Validity is either 18, 24 or 30 hours depending on which aerodrome type and category of TAF (A or B).
A	International:	Issued 6 hourly, valid for 18, 24 or 30 hours. Commencement times 00, 06, 12, 18 UTC
B	Large:	Issued 6 hourly, valid for 12 or 18 hours. Commencement times 00, 06, 12 and 18 UTC.
C	Medium:	Issued 6 hourly, typically valid for 12 hours. Commencement times are 02, 08, 14 and/or 20 UTC, except in Western Australia where commencement times are 04, 10, 16 and/or 22 UTC.
D	Small:	Issued 6 or 12 hourly, valid for up to 12 hours. Commencement times are typically 20 and/or 02 UTC, except in Western Australia where commencement times are typically 22 and/or 04 UTC.

Note 1: Commencement times for C and D TAF will be one hour earlier in states using daylight saving.

Note 2: TAF will be provided upon request for other locations in support of SAR and emergency flights.

*Note 3: TAF3 aerodromes may not have H24 TAF3 service. MO hours for TAF3 watch and routine TAF3 validity periods are annotated in *ERSA*.*

Note 4: TAF3 is identical in format to any other TAF and can be identified by the indicator "TAF3" in the RMK section of the TAF.

4.8.3 Amendments, labelled TAF AMD, are issued immediately once the need is recognised.

4.8.4 More information on TAF3 and TAF can be found in the product information section of BoM Aviation Knowledge Centre: www.bom.gov.au/aviation/knowledge-centre/.

Note: Flight planning requirements for TAF can be found at ENR 1.10 para 1.2.4.

4.9 Airport Weather Briefings (AWB)

4.9.1 AWB are provided for Brisbane (YBBN), Melbourne (YMML), Adelaide (YPAD), Perth (YPPH), Sydney (YSSY); and Darwin (YPDN - only available during the wet season). The AWB is provided to expand on the information provided in the TAF. Once issued, it is not amended or updated.

4.9.2 **ADF - Local Area Forecasts (Military)**. Local area forecasts are detailed forecasts for areas approximately 50 to 100NM in radius centred on an airfield, or for other specified areas. Local area forecasts prepared for military operations are usually similar in form and content to GAFs, but variations to cater for the unique requirements of some various operations are included by special arrangement.

4.9.3 **ADF - Airport Warnings.** Airport Warnings are issued at military aerodromes for the protection of parked aircraft. An airport warning will be issued if any of the following occurrences are expected or observed:

- a. gale (mean speed of surface wind is expected to exceed 34KT, or when gusts in excess of 41KT are expected);
- b. squall;
- c. thunderstorm;
- d. sandstorm;
- e. dust storm;
- f. rising sand or dust;
- g. hail;
- h. frost;
- i. rime;
- j. snow;
- k. freezing precipitation;
- l. rough sea;
- m. heavy swell; or
- n. flooding.

4.10 Wind Shear Warnings

4.10.1 Aircraft reports of wind shear encountered during climb and descent are the primary means of detecting wind shear. The MO provides advice, when possible, on the likely duration of the event and a forecast low level wind.

4.10.2 Wind Shear Warnings for an event will specify a validity period, and sequence numbers will be assigned to each warning associated with an event. A Wind Shear Warning will be cancelled when wind shear is no longer expected. Locations where this service is provided is published in ERSA FAC.

4.10.3 When wind shear is forecast or reported by pilots at an intensity greater than "light", this information, together with a forecast low level wind, will be included on the ATIS at any of the above aerodromes.

4.10.4 More information on wind shear can be found in the Hazardous Phenomena section of BoM Aviation Knowledge Centre: www.bom.gov.au/aviation/knowledge-centre/.

4.10.5 Microburst and wind shear alerts

In addition to wind shear warnings, remote sensing technology has been deployed at some locations (see ERSFA FAC) to provide alerts when low level wind shear and microburst activity has been detected.

Air traffic controllers will issue a microburst or wind shear alert to affected aircraft using standard phraseology when the following conditions are detected:

	Wind	Alert
Headwind gain	>15 KT	Wind shear
Headwind loss	>15 KT	Wind shear
	>30 KT	Microburst

If multiple instances of wind shear/microbursts are detected on the same runway corridor, an alert will only be issued for the instance with the greatest intensity.

If instances of both wind loss and wind gain are detected on the same runway corridor, an alert will only be issued for the wind loss instance.

4.11 Volcanic Ash Advisories (VAA)

4.11.1 Volcanoes to the north and east of Australia are monitored by the Darwin Volcanic Ash Advisory Centre (VAAC) operated by the BoM.

4.11.2 If required, the Darwin VAAC will issue a "Volcanic Ash Advisory" in both text and graphical form.

4.11.3 More information on VAA can be found in the Product Information section of BoM Aviation Knowledge Centre: www.bom.gov.au/aviation/knowledge-centre/.

4.11.4 The Melbourne MWO is responsible for issuing Volcanic Ash SIGMET in the Australian FIR based on information from VAA.

4.11.5 Refer to *para 8.1* for more information on SIGMET.

4.11.6 During times of prolonged volcanic activity, in conjunction with neighbouring States, temporary airspace and airways will be established to avoid hazardous areas and notified by NOTAM.

4.12 Space Weather (SWX)

4.12.1 The BoM is part of one of the ICAO designated aviation Space Weather Centres (SWXC) established to deliver space weather (SWX) services.

4.12.2 The SWXC monitor and provide current conditions, advisories and forecasts of space weather phenomena with the potential to impact:

- a. high frequency radio communications (HF COM);
- b. global navigation satellite systems (GNSS) based navigation and surveillance systems;
- c. radiation effects on avionics and/or human health (RADIATION).

4.12.3 A space weather advisory is issued whenever space weather conditions exceed pre-defined ICAO thresholds as defined in *ICAO Doc 10100* for both moderate impacts (MOD) and severe impacts (SEV).

4.12.4 More information on Space Weather Advisories can be found in the Product Information section of BoM Aviation Knowledge Centre: www.bom.gov.au/aviation/knowledge-centre/.

Note: SIGMET are not issued for Space Weather.

4.13 Tropical Cyclones (TC)

4.13.1 The Darwin Tropical Cyclone Advisory Centre (TCAC) is operated by BoM and is responsible for issuing "Tropical Cyclone Advisories" in text and graphical formats for its area of responsibility.

4.13.2 A Tropical Cyclone Advisory (TCA) provides information concerning the position of the cyclone centre, its direction and speed of movement, central pressure and maximum surface wind near the centre.

4.13.3 The Melbourne MWO is responsible for issuing Tropical Cyclone SIGMET in the Australian FIR based on information from TCA. Refer to *para 8.1* for more information on SIGMET.

5. NOTIFICATION REQUIRED FROM OPERATORS

5.1 For International Operations

Forecast Required	Availability	Notice Required
Preliminary operational planning (to assist in the general planning of the following day's operations)	3-24 hours before EOBT	8 hours
Preflight	At least 3 hours before EOBT	8 hours
En route	As arranged	

5.2 For Domestic Operations

5.2.1 All meteorological information issued on a routine basis and held by the NOMC Pilot Briefing Office is available without prior notice. For non-routine forecasts the MO requires 8 hours notice.

5.3 Forecasts for Flights - Valid GAF not Available

5.3.1 'Flight Forecasts required for flights for which valid GAF are not available will be supplied subject to the request being received three days prior to departure and forecaster capacity to provide the service.

Note: Every effort will be made to expedite MET documentation for urgent flights.

5.3.2 Notification should include part or all of the following information as applicable:

- a. departure aerodrome and EOBT;
- b. destination and ETA;
- c. route;
- d. ETA and EOBT for any intermediate stopping places;
- e. heights for upper winds and temperatures; and
- f. time documentation required.

6. AIRCRAFT REPORTS

6.1 Routine Aircraft Observations

6.1.1 Routine Observations in Australian FIR are only required from aircraft equipped with Aircraft Meteorological Data Relay (AMDAR).

6.1.2 AMDAR equipped aircraft should transmit routine meteorological observations:

- a. at waypoints indicated by the symbols



on en route charts (ERC-L and ERC-H).

- b. at MET reporting points shown on charts which are used in lieu of Australian AIP aeronautical charts.
- c. whenever conditions experienced are significantly above or below those forecast.

6.1.3 In areas where ground meteorological reports are infrequent or any hazardous weather is encountered, or observed either visually or by radar, aircraft captains are encouraged to report observations of MET conditions which they consider will assist in the provision of meteorological services.

6.1.4 Routine weather observations should be reported in accordance with the AIREP Format shown in *ENR 1.1 APPENDIX 1*.

6.2 AIREP Special

6.2.1 The aircraft captain should make an AIREP Special report when requested, or as soon as practicable after encountering or observing hazardous meteorological conditions which, in the opinion of the pilot are, or may become, severe enough to warrant a SIGMET, regardless of any reports from other aircraft and regardless of any SIGMET issued.

6.3 Wind Shear - Reporting

6.3.1 Wind shear encountered by aircraft should be reported by pilots to ATS as aircraft following may not have the performance required to recover from the same wind shear encounter. The wind shear may also be increasing in intensity, making flight through the wind shear more dangerous for following traffic.

6.3.2 Due to flight deck workload, reports may be initially reported as WIND SHEAR ESCAPE and a full report provided when workload allows.

6.3.3 The full report should include:

- a. an assessment of the intensity as follows:
- (1) light - shear causing minor excursions from flight path and/or airspeed;
 - (2) moderate - shear causing significant effect on control of the aircraft;
 - (3) strong - shear causing difficulty in keeping the aircraft to desired flight path and/or airspeed;
 - (4) severe - shear causing hazardous effects to aircraft controllability; and
- b. a factual plain language report regarding airspeed/ground speed changes (gain or loss) or undershoot/overshoot effects; and
- c. the altitude or altitude band at which the adverse effect was experienced; and
- d. where practicable, other relevant information such as significant changes in wind direction and/or speed may be included.

6.3.4 At non-controlled aerodromes, the report should also be broadcast to all aircraft on the CTAF and should include the name of the aerodrome.

6.4 Volcanic Activity Reports

6.4.1 Volcanic activity reports should be made by the pilot of an aircraft whenever observed, regardless of any previous reports from other aircraft. See ENR 1.1 APPENDIX 1 for a sample form Volcanic Activity Reporting (Model VAR).

7. VOLMET SERVICE

Specific information regarding the VOLMET service is detailed in the following table:

Name of station	Callsign/IDENT/Abbreviation (EM)	Frequency	Broadcast period	Hours of Service	Aerodromes/Helpports Included	REP, SIGMET INFO, FCST and Remarks
1	2	3	4	5	6	7
Alice Springs	VKA-930 VKA-931 'Australian'	6676kHz 11387kHz	H24	H+00 to H+05 and H+30 to H+35	Adelaide Brisbane Cairns Darwin Melbourne Perth Sydney Townsville	– METAR/ SPECI – TAF where significant – Availability of SIGMET (see note)
Bellenden Keir		119.75MHz	H24	Continuous	Amberley Brisbane Cairns Hamilton Island Mackay Rockhampton Townsville	– METAR/ SPECI – TAF where significant
Broken Hill		128.25MHz	H24	Continuous	Adelaide Alice Springs Amberley Brisbane Darwin Melbourne Sydney	– METAR/ SPECI – TAF where significant

Name of station	Call sign/ IDENT/ Abbreviation (EM)	Frequency	Broadcast period	Hours of Service	Aerodromes/ Heliports included	REP, SIGMET INFO, FCST and Remarks
1	2	3	4	5	6	7
Ceduna		128.45MHz	H24	Continuous	Adelaide Alice Springs Kalgoorlie Melbourne Perth Sydney	- METAR/ SPECI - TAF where significant
Derby		128.45MHz	H24	Continuous	Broome Darwin Kununurra Meekatharra Perth Port Hedland	- METAR/ SPECI - TAF where significant
Goochegoochera		128.45MHz	H24	Continuous	Alice Springs Cairns Darwin Tennant Creek Tindal Townsville	- METAR/ SPECI - TAF where significant

Name of station	Callsign/ IDENT/ Abbreviation (EM)	Frequency	Broadcast period	Hours of Service	Aerodromes/ Heliports included	REP, SIGMET INFO, FCST and Remarks
1	2	3	4	5	6	7
Kalgoorlie		128.25MHz	H24	Continuous	Adelaide Alice Springs Ceduna Kalgoorlie Laverton Perth	– METAR/ SPECI – TAF where significant
Meekatharra		128.45MHz	H24	Continuous	Broome Karratha Meekatharra Mount Magnet Paraburdoo Perth Port Hedland	– METAR/ SPECI – TAF where significant
Mt Blackwood		119.85MHz	H24	Continuous	Amberley Brisbane Cairns Hamilton Island Mackay Rockhampton Townsville	– METAR/ SPECI – TAF where significant

Name of station	Call sign/ IDENT/ Abbreviation (EM)	Frequency	Broadcast period	Hours of Service	Aerodromes/ Heliports included	REP, SIGMET INFO, FCST and Remarks
1	2	3	4	5	6	7
Mt Canobolas		127.7MHz	H24	Continuous	Adelaide Alice Springs Amberley Brisbane Melbourne Perth Sydney Williamtown	– METAR/ SPECI – TAF where significant
Mt Gimini		128.65MHz	H24	Continuous	Adelaide Canberra Hobart Melbourne Wagga Wagga	– METAR/ SPECI – TAF where significant
Mt Isa		120.35MHz	H24	Continuous	Alice Springs Amberley Brisbane Cairns Mt Isa Tindal Townsville	– METAR/ SPECI – TAF where significant

Name of station	Callsign/ IDENT/ Abbreviation (EM)	Frequency	Broadcast period	Hours of Service	Aerodromes/ Heliports Included	REP, SIGMET INFO, FCST and Remarks
1	2	3	4	5	6	7
Mt Mowbrall		119.95MHz	H24	Continuous	Amberley Brisbane Gold Coast Mackay Rockhampton Sunshine Coast Sydney	- METAR/ SPECI - TAF where significant
Mt William		119.75MHz	H24	Continuous	Adelaide Hobart Launceston Melbourne Mildura Perth	- METAR/ SPECI - TAF where significant
Point Lookout		119.75MHz	H24	Continuous	Amberley Brisbane Canberra Gold Coast Melbourne Rockhampton Sydney Williamtown	- METAR/ SPECI - TAF where significant

Note: Due to broadcast time constraints TAF for a location will be included only if significant elements are forecast during the first three hours of validity. If no significant elements are forecast in this period the identifier NOSIG will be broadcast in place of the TAF details following the METAR/SPECI for that location. Cloud types, excepting cumulonimbus, will not be included in VOLMET broadcasts.

8. SIGMET AND AIRMET SERVICES

8.1 SIGMET

8.1.1 SIGMET is a concise description of the occurrence or expected occurrence, in an area over which area meteorological watch is maintained, of specified phenomena which may affect the safety of aircraft operations.

Note: Due to broadcast time constraints TAF for a location will be included only if significant elements are forecast during the first three hours of validity. If no significant elements are forecast in this period the identifier NOSIG will be broadcast in place of the TAF details following the METAR/SPECI for that location. Cloud types, excepting cumulonimbus, will not be included in VOLMET broadcasts.

8.1.2 SIGMET are issued by MWO and disseminated by ATS as an element of ATC initiated FIS to aircraft operating on routes or in areas likely to be affected. This information will normally relate the phenomenon reported to designated reporting points and where possible will indicate the area in which the phenomenon exists.

MWO	HR	FIR	Type and Validity
Melbourne	H24	YBBB YMMM	SIGMET 4HR
Specific procedures:			
a. SIGMET for turbulence or icing above 10,000FT are issued north of 50°S. SIGMET for turbulence or icing above 10,000FT south of 50°S upon request.			
b. SIGMET for thunderstorms are issued for north of 50°S.			
c. SIGMET for phenomena at and below 10,000FT (other than thunderstorms, tropical cyclones and volcanic ash) are issued for GAF areas, and outside GAF areas upon request.			
Melbourne	H24	YBBB YMMM	SIGMET VA/TC 6HR
Specific procedures: Nil			
Brisbane	H24	YBBB YMMM	SIGMET 4HR
Specific procedures:			
a. SIGMET for phenomena at and below 10,000FT (other than thunderstorms, tropical cyclones and volcanic ash) are issued for GAF areas, and outside GAF areas upon request.			

8.1.3 SIGMET for volcanic ash cloud and tropical cyclones is issued for the whole of Melbourne and Brisbane FIR (YMMM and YBBB).

8.1.4 SIGMET are issued in both text and graphical format.

8.1.5 If a text SIGMET cannot be rendered graphically, it will be displayed in text format on the graphic.

8.1.6 More information on SIGMET can be found in the Product Information section of BoM Aviation Knowledge Centre: www.bom.gov.au/aviation/knowledge-centre/.

8.2 AIRMET

8.2.1 AIRMET information concerns the occurrence or expected occurrence, in an area over which meteorological watch is being maintained, of one or more of the following phenomena when the phenomena have not been included in a current GAF.

8.2.2 AIRMET information, which concerns phenomena of a lesser degree of severity than SIGMET information, is given to aircraft operating at or below 10,000FT.

8.2.3 AIRMET information is issued by MWO disseminated by ATS as an element of ATC initiated FIS, to aircraft operating on routes or in areas likely to be affected. It will indicate the locality or area in which the phenomena exist or are expected to exist.

8.2.4 AIRMET are issued in both text and graphical format. More information on AIRMET, including the phenomena that warrant issuance, can be found in the Product Information section of BoM Aviation Knowledge Centre: www.bom.gov.au/aviation/knowledge-centre/.

9. OTHER AUTOMATED METEOROLOGICAL SERVICES

9.1 Aerodrome Weather Information Service (AWIS) and Weather and Terminal Information Reciter (WATIR)

9.1.1 AWIS and WATIR transmit meteorological information from the Automatic Weather Station via a phone number, or at some aerodromes via a VHF radio broadcast. WATIR combines the meteorological information with additional terminal information from the airport operator. AWIS and WATIR information is classed as "real time" data.

9.1.2 Some, or all of the following information may be provided:

- a. Message identifier e.g. "AWS AERODROME WEATHER" OR "AUTOMATED WEATHER INFORMATION SERVICE",
- b. Station identifier as a plain language station name;
- c. time (UTC);
- d. wind direction in degrees magnetic and speed in knots;
- e. visibility;
- f. RVR (where available);
- g. present weather;
- h. cloud below 10,000FT, amount and height;
- i. temperature in whole degrees Celsius;
- j. dew point in whole degrees Celsius;
- k. QNH in whole hectopascals;
- l. rainfall (last 10 minutes).

9.1.3 When information is not available the relevant element of the broadcast will be identified as "[ELEMENT NAME] CURRENTLY NOT AVAILABLE"; e.g. "TEMPERATURE CURRENTLY NOT AVAILABLE".

9.1.4 When the information from the AWIS is determined as being corrupt a NOTAM will be issued.

9.1.5 The QNH from a BoM managed or BoM approved AWS is an approved source of QNH and may be used in accordance with *ENR 1.5 para 5.3*.

9.1.6 When AWIS information is available after hours (AH), and the aerodrome is uncontrolled, reference will be made to its availability in ATIS UTC.

9.1.7 The availability of AWIS and WATIR is contained in *ERSA FAC*.

APPENDIX 1. MEAN EQUIVALENT WIND COMPONENT TABLES

1.1 Introduction

1.1.1 These tables show mean seasonal wind components and ambient temperatures at standard pressure levels for selected routes. Each set of figures has been calculated against the following TAS Range and levels.

PRESSURE LEVELS	APPROXIMATE ALTITUDE	TAS RANGE
700 HPA	10,000 FT	150 - 250 KT
500 HPA	20,000 FT	200 - 400 KT
300 HPA	30,000 FT	200 - 500 KT
200 HPA	40,000 FT	300 - 600 KT
150 HPA	45,000 FT	400 - 600 KT
100 HPA	50,000 FT	400 - 600 KT

1.1.2 The routes are Great Circles but, wherever possible, they have been selected to coincide with existing ATS Routes. Distances are Great Circle Distances.

1.1.3 On 50% of occasions the wind component is more favourable than that quoted. The following table provides a factor K corresponding to a selected percentage number of occasions:

%	5	10	15	20	30	40	50	60	70	80	85	90	95
K	1.65	1.28	1.04	0.84	0.52	0.25	0	-0.25	-0.52	-0.84	-1.04	-1.28	-1.65

In order to calculate the value of wind components for a selected percentage:

- Extract the K factor corresponding to the desired percentage.
- Select the values of 'O' or 'H' and 'SD' for the required height and season.
- The value of wind component equals the algebraic sum of O or H + (K x SD).

Example: ADELAIDE-PERTH, MAR-MAY, 300HPA level:

70% value = $41 + (-0.52 \times 16) = -49.3$, i.e., wind component is more favourable than a headwind of 49KT on 70% of occasions.

1.1.4 Decode:

- O - average wind component for route outbound;
- H - average wind component for route inbound;
- SD - standard deviation;
- T - average temperature in degrees Centigrade; and
- Negative signs against wind component indicate a headwind.

1.2 Mean Equivalent Wind Table (Dec-May)

ROUTE		HPA	DEC - FEB				MAR - MAY			
A	B		O	H	SD	T	O	H	SD	T
ADELAIDE 34 57'S 138 32'E 3099NM	BUCHHOLZ 08 43'N 167 44'E	700	0	0	6	9.2	0	-1	7	7.5
		500	0	-2	6	-6.4	5	-6	7	-7.4
		300	4	-5	9	-31.8	14	-15	10	-33.3
		200	9	-10	11	-53.3	16	-18	12	-54.3
		100	1	-2	9	-80.0	10	-11	9	-77.7
ADELAIDE 34 57'S 138 32'E 524NM	CANBERRA 35 18'S 149 12'E	700	14	-15	12	5	14	-15	12	-1
		500	18	-19	14	-12	25	-26	16	-17
		300	34	-35	19	-38	38	-40	21	-43
		200	41	-43	22	-55	48	-50	24	-56
		150	40	-42	21	-60	49	-50	20	-59
		100	21	-22	15	-67	36	-37	16	-62
ADELAIDE 34 57'S 138 32'E 1415NM	DARWIN 12 25'S 130 53'E	700	7	-8	10	8.6	3	-4	10	5.4
		500	7	-9	12	-8.2	-1	0	11	-9.7
		300	-7	5	14	-33.4	-10	5	17	-36.1
		200	-10	6	18	-52.9	-17	10	20	-55.0
		100	-5	4	13	-76.3	-10	8	13	-73.6
ADELAIDE 34 57'S 138 32'E 1491NM	LEARMONTH 22 14'S 114 05'E	700	-1	0	9	8.1	-9	8	10	4.2
		500	-13	12	11	-8.8	-21	19	12	-11.7
		300	-28	26	14	-35.8	-39	36	19	-38.3
		200	-43	41	19	-53.7	-53	49	22	-55.9
		100	-20	19	12	-73.2	-31	29	13	-70.7
ADELAIDE 34 57'S 138 32'E 1259NM	MACQUARIE ISLAND 54 40'S 148 52'E	700	6	-11	14	-1.7	9	-14	15	-4.3
		500	8	-13	18	15.9	13	-15	20	-20.3
		300	14	-23	24	-42.5	15	-22	26	-46.3
		200	17	-24	23	-54.0	17	-23	25	-56.4
		100	10	-13	11	-56.8	13	-17	14	-57.4
ADELAIDE 34 57'S 138 32'E 1141NM	PERTH 31 56'S 115 58'E	700	-7	8	10	6	-12	13	11	1
		500	-18	19	12	-11	-22	24	14	-15
		300	-29	33	18	-37	-41	44	16	-42
		200	-36	40	18	-54	-49	51	20	-57
		150	-37	38	15	-60	-49	51	18	-60
		100	-16	17	10	-67	-33	35	13	-63
ADELAIDE 34 57'S 138 32'E 1039NM	TOWNSVILLE 19 15'S 146 46'E	700	6	-8	11	7.6	5	-6	11	3.6
		500	10	-12	13	-8.0	9	-12	14	-11.7
		300	15	-18	16	-34.2	15	-22	21	-38.0
		200	21	-26	21	-53.3	19	-27	24	-55.2
		100	12	-14	14	-74.7	11	-14	15	-70.2
ALICE SPRINGS 23 49'S 133 54'E 1042NM	AMBERLEY 27 39'S 152 43'E	700	-6	5	10	7.8	1	-3	11	3.6
		500	9	-10	11	-7.8	15	-17	13	-11.7
		300	26	-28	17	-33.8	41	-44	22	-38.1
		200	39	-41	22	-52.7	60	-63	25	54.9
		100	18	-19	15	-75.3	35	-37	15	-70.1

ROUTE			DEC - FEB				MAR - MAY			
A	B	HPA	O	H	SD	T	O	H	SD	T
ALICE SPRINGS 23 49'S 133 54'E 1098NM	LEARMONTH 22 14'S 114 05'E	700	4	-6	9	10.2	-2	1	10	6.5
		500	0	-1	10	-6.8	-19	18	11	-8.7
		300	-17	16	13	-32.3	-46	44	49	-35.0
		200	-36	34	17	-52.3	-65	63	23	-54.7
		100	-11	9	14	-79.3	-36	35	15	-75.3
ALICE SPRINGS 23 49'S 133 54'E 1151NM	PORT MORESBY 09 27'S 147 13'E	700	-3	1	9	9.6	0	0	9	7.8
		500	4	-5	9	-5.5	9	-10	10	-6.7
		300	10	-11	13	-30.6	18	-21	15	-32.7
		200	18	-20	17	-52.7	25	-28	19	-54.0
		100	2	-3	13	-81.6	9	-11	13	-78.7
AUCKLAND 36 51'S 174 46'E 411NM	CHRISTCHURCH 43 29'S 172 32'E	700	-5	3	15	1	-6	3	16	-2
		500	-8	4	19	-15	-9	5	19	-19
		300	-13	7	28	-42	-15	8	26	-45
		200	-13	7	27	-55	-14	8	25	-55
		150	-13	9	25	-58	-13	9	19	-57
100	-7	6	13	-61	-8	6	13	-59		
AUCKLAND 36 51'S 174 46'E 1155NM	FIJI 17 45'S 177 27'E	700	1	-3	10	7	0	-2	10	5
		500	1	-3	12	-9	1	-3	11	-12
		300	3	-7	17	-36	3	-14	17	-27
		200	3	-9	17	-54	1	-8	20	-54
		150	6	-11	15	-63	1	-9	16	-64
100	4	-5	10	-72	3	-7	11	-70		
BAUERFIELD 17 42'S 168 19'E 522NM	FIJI 17 45'S 177 27'E	700	1	-2	9	10	1	-1	8	9
		500	7	-7	12	-5	13	-13	10	-7
		300	17	-18	16	-32	20	-21	16	-33
		200	34	-35	16	-53	32	-33	21	-53
		150	27	-27	18	-67	28	-29	18	-66
100	11	-11	13	-79	16	-16	14	-77		
BRISBANE 27 25'S 153 05'E 872NM	ADELAIDE 34 57'S 138 32'E	700	-8	7	10	6	-9	9	11	1
		500	-17	16	12	-11	-21	19	14	-15
		300	-31	28	18	-36	-40	37	17	-41
		200	-44	40	18	-54	-52	45	19	-55
		150	-37	36	15	-62	-49	41	18	-62
100	-21	20	10	-71	-33	30	13	-66		
BRISBANE 27 25'S 153 05'E 1234NM	AUCKLAND 36 51'S 174 46'E	700	5	-6	10	5	9	-10	11	1
		500	14	-15	12	-12	20	-23	23	-15
		300	28	-30	17	-38	31	-35	17	-41
		200	39	-42	18	-54	47	-50	19	-54
		150	30	-33	15	-61	49	-51	16	-61
100	15	-16	9	-68	35	-37	12	-66		
BRISBANE 27 25'S 153 05'E 2392NM	BUCHOLZ 08 43'N 167 44'E	700	-1	0	7	9.8	1	0	7	9.1
		500	-2	1	7	-5.6	0	0	7	-5.7
		300	-1	0	9	-35.7	4	-5	10	-31.5
		200	-1	2	11	-53.0	6	-7	12	-53.7
		100	-1	0	11	-81.9	4	-5	10	-80.2

ROUTE			DEC - FEB				MAR - MAY			
A	B	HPA	O	H	SD	T	O	H	SD	T
BRISBANE 27 25'S 153 05'E 1347NM	CHRISTCHURCH 43 29'S 172 32'E	700	7	-8	10	4	8	-10	11	-1
		500	13	-14	13	-13	16	-19	13	-17
		300	19	-23	18	-39	23	-29	18	-43
		200	26	-30	18	-55	32	-37	19	-55
		150	21	-24	17	-60	34	-37	15	-59
100	10	-11	10	-66	24	-26	19	-63		
BRISBANE 27 25'S 153 05'E 1560NM	DARWIN 12 25'S 130 53'E	700	-3	2	7	9	3	-4	6	6
		500	-5	4	8	-6	-9	9	8	-8
		300	-11	9	11	-32	-26	22	10	-34
		200	-23	19	11	-52	-37	31	12	-53
		150	-15	14	11	-66	-35	31	11	-66
100	-6	4	9	-78	-19	17	9	-76		
BRISBANE 27 25'S 153 05'E 1149NM	HONIARA 09 25'S 160 02'E	700	0	-2	9	9.3	0	-1	9	5.2
		500	0	0	9	-5.7	3	-4	10	-6.7
		300	2	-4	14	-31.1	4	-9	15	-32.5
		200	3	-5	17	-52.8	6	-10	19	-53.8
		100	2	0	13	-80.5	3	-5	13	-77.9
BRISBANE 27 25'S 153 05'E 1465NM	NADI 17 45'S 177 26'E	700	0	0	8	8.6	6	-7	9	6.9
		500	9	-11	11	-6.1	21	-22	10	-8.1
		300	31	-32	9	-31.5	46	-49	18	-34.1
		200	36	-38	17	-52.9	63	-65	21	-53.7
		100	17	-18	13	-77.5	29	-31	14	-73.9
BRISBANE 27 25'S 153 05'E 601NM	TOWNSVILLE 19 15'S 146 46'E	700	-2	1	10	8	-1	0	9	5
		500	-3	2	11	-7	-8	7	12	-10
		300	-10	8	14	-32	-23	18	16	-35
		200	-22	19	16	-52	-36	30	21	-53
		150	-12	6	16	-65	-32	28	19	-65
100	-3	2	13	-76	-18	16	19	-73		
BUCHOLZ 08 43'N 167 44'E 1374NM	GUAM 13 34'N 144 55'E	700	9	-9	6	10	9	-9	5	10
		500	13	-13	7	-4	8	-9	6	-5
		300	6	-6	8	-30	-5	5	8	-32
		200	-1	0	9	-52	-8	8	10	-54
		150	4	-5	9	-66	-2	2	11	-66
100	16	-16	9	-76	3	-4	10	-77		
BUCHOLZ 08 43'N 167 44'E 1414NM	JOHNSTON 16 44'N 169 31'W	700	-6	6	8	9	-9	9	5	9
		500	-5	5	9	-6	-7	7	7	-6
		300	7	-9	12	-32	15	-17	12	-33
		200	11	-12	13	-52	26	-28	15	-54
		150	11	-12	11	-65	23	-25	13	-65
100	-2	2	10	-77	13	-14	11	-76		
BUCHOLZ 08 43'N 167 44'E 1689NM	FIJI 17 45'S 177 27'E	700	0	-1	5	11	-1	0	4	10
		500	-3	2	7	-3	0	-1	6	-5
		300	-1	0	10	-31	2	-3	9	-31
		200	0	-1	10	-53	7	-8	11	-53
		150	-1	0	10	-68	5	-6	10	-67
100	-3	2	9	-80	3	-4	9	-80		

ROUTE		HPA	DEC - FEB				MAR - MAY			
A	B		O	H	SD	T	O	H	SD	T
BUCHOLZ 08 43'N 167 44'E 1640NM	PORT MORESBY 09 26'S 147 13'E	700	0	-1	4	11	0	0	4	10
		500	6	-7	6	-3	4	-4	5	-5
		300	3	-4	7	-31	-5	5	7	-31
		200	-2	2	8	-53	-10	10	9	-52
		150	0	-1	8	-68	-8	8	9	-67
100	-2	1	9	-81	-4	4	9	-80		
BUTTERWORTH 05 28'N 100 24'E 507NM	BANGKOK 13 55'N 100 37'E	700	-4	2	9	8.2	-3	2	9	9.6
		500	-1	0	9	-6.4	2	-3	8	-5.8
		300	-3	1	9	-31.5	3	-5	12	-31.5
		200	12	-14	10	-54.4	7	-9	15	-53.8
		100	11	-13	13	-81.0	5	-6	13	-81.3
BUTTERWORTH 05 28'N 100 24'E 935NM	KOTA KINABALU 05 56'N 116 03'E	700	7	-8	8	8.6	-4	3	8	9.8
		500	-11	10	8	-6.0	-10	9	7	-5.5
		300	-16	15	8	-31.5	-6	5	10	-31.1
		200	-17	15	9	-54.4	-6	5	12	-54.0
		100	-19	17	12	-81.2	-5	4	12	-82.4
BUTTERWORTH 05 28'N 100 24'E 324NM	SINGAPORE 01 21'N 103 54'E	700	0	0	9	2.4	-1	2	9	9.2
		500	-2	1	9	-6.2	-5	4	8	-5.9
		300	-6	4	9	-31.5	-6	4	11	-31.2
		200	-21	20	10	-54.4	-10	8	13	-53.8
		100	-18	16	12	-81.2	-7	6	14	-82.4
CALCUTTA 22 39'N 88 27'E 1398NM	KUALA LUMPUR 03 07'N 101 33'E	700	0	-1	6	9	3	-4	6	10
		500	-1	0	8	-6	0	0	7	-5
		300	8	-10	10	-32	4	-5	11	-30
		200	7	-10	11	-56	2	-4	12	-51
		150	9	-12	12	-68	4	-5	14	-66
100	-4	1	11	-79	4	-5	10	-76		
CANBERRA 35 18'S 149 12'E 1240NM	AUCKLAND 36 51'S 174 46'E	700	12	-13	11	4	14	-16	11	-1
		500	19	-20	13	-13	25	-26	13	-18
		300	34	-36	18	-40	38	-40	19	-44
		200	41	-43	19	-56	47	-49	20	-55
		150	34	-40	18	-60	49	-50	16	-58
100	20	-21	10	-65	34	-35	12	-62		
CANBERRA 35 18'S 149 12'E 518NM	BRISBANE 27 25'S 153 05'E	700	8	-7	11	6	5	-6	11	1
		500	10	-11	13	-11	9	-11	11	-15
		300	15	-19	18	-36	17	-23	20	-41
		200	18	-22	20	-54	17	-25	24	-54
		150	22	-25	19	-61	17	-24	21	-62
100	13	-14	14	-71	14	-17	19	-66		
CANBERRA 35 18'S 149 12'E 1183NM	CHRISTCHURCH 43 29'S 172 32'E	700	14	-15	11	2	14	-16	12	-3
		500	20	-22	14	-15	24	-25	14	-20
		300	29	-32	21	-41	31	-35	20	-46
		200	34	-36	20	-56	39	-42	19	-56
		150	32	-34	19	-58	40	-42	16	-57
100	17	-17	11	-62	29	-30	11	-60		

ROUTE			DEC - FEB				MAR - MAY			
A	B	HPA	O	H	SD	T	O	H	SD	T
CHRISTCHURCH 43 29'S 177 32'E	McMURDO 77 53'S 166 48'E	700	-3	0	9	-10	-3	1	9	-12
		500	-5	1	13	-24	-3	-1	13	-28
		300	-8	0	19	-47	-7	1	17	-51
		200	-6	0	16	-47	-7	1	13	-52
		150	-5	1	13	-46	-3	-1	11	-53
2080NM		100	-5	3	7	-46	-2	0	9	-53
COCOS 12 12'S 96 50'E	DARWIN 12 25'S 130 53'E	700	5	-5	5	10	-8	8	5	9
		500	-3	3	7	-5	5	-6	6	-6
		300	0	0	3	-31	10	-11	8	-32
		200	5	-6	9	-54	13	-14	9	-33
		150	5	-5	9	-68	14	-15	9	-68
1995NM		100	-6	5	9	-82	10	-11	8	-78
COCOS 12 12'S 96 50'E	DIEGO GARCIA 07 18'S 72 24'E	700	10	-11	7	9.2	8	-9	7	9.7
		500	15	-16	7	-6.0	5	-6	7	-5.1
		300	15	-16	7	-32.2	-5	3	9	-30.9
		200	16	-17	8	-54.2	-2	1	11	-53.0
		100	16	-17	11	-80.4	4	-6	11	-81.1
1474NM										
COCOS 12 12'S 96 50'E	LEARMONTH 22 14'S 114 05'E	700	-8	7	8	9.5	-3	2	8	9.0
		500	-8	7	8	-6.0	8	-9	9	-6.4
		300	3	-5	10	-31.7	29	-31	13	-32.2
		200	3	-4	12	-53.5	34	-36	17	-54.1
		100	-4	3	12	-81.1	20	-21	12	-79.7
1156NM										
COCOS 12 12'S 96 50'E	PERTH 31 56'S 115 58'E	700	1	-1	8	9	-1	1	8	6
		500	4	5	9	-7	8	-9	9	-9
		300	8	-11	13	-33	19	-21	12	-35
		200	12	-16	13	-54	21	-25	14	-54
		150	10	-12	11	-65	19	-23	13	-54
1586NM		100	-1	-1	8	-77	12	-15	10	-75
COCOS 12 12'S 96 50'E	SEYCHELLES 04 40'S 55 31'E	700	6	-7	6	9.5	8	-9	5	9.9
		500	15	-16	6	-6.0	6	-7	5	-4.8
		300	13	-14	6	-31.4	-1	0	7	-30.6
		200	14	-16	7	-53.8	-3	2	9	-52.4
		100	19	-20	9	-80.3	4	-5	9	-80.4
2490NM										
COLOMBO 06 54'N 79 52'E	COCOS 12 12'S 96 50'E	700	5	-6	6	10	-3	3	5	9
		500	-5	5	8	-5	-4	3	6	-5
		300	-3	2	9	-31	0	1	7	-31
		200	-6	5	10	-54	-1	0	9	-51
		150	-8	7	10	-69	-1	0	8	-68
1529NM		100	-10	8	9	-82	-1	0	8	-78
DARWIN 12 25'S 130 53'E	ADELAIDE 34 57'S 138 32'E	700	0	-1	7	9	-1	0	8	5
		500	0	-1	9	-8	1	-3	9	-10
		300	0	-4	13	-33	8	-12	12	-36
		200	1	-4	13	-53	7	-13	14	-54
		150	3	-5	11	-64	11	-17	13	-64
1415NM		100	-2	0	9	-76	5	-8	10	-73

GEN 3.5

ROUTE		HPA	DEC - FEB				MAR - MAY			
A	B		O	H	SD	T	O	H	SD	T
DARWIN 12 25'S 130 53'E 2188NM	BAUERFIELD 17 42'S 168 19'E	700	0	0	5	10	-5	4	5	8
		500	2	-3	7	-5	8	-8	6	-6
		300	5	-6	8	-31	13	-14	9	-32
		200	24	-24	8	-52	24	-24	11	-53
		150	15	-16	9	-67	23	-24	10	-67
100	5	-6	9	-81	11	-11	9	-78		
DARWIN 12 25'S 130 53'E 1411NM	BRUNEI 04 57'N 114 56'E	700	-1	1	5	10	-1	1	6	10
		500	5	-5	6	-5	2	-2	5	-5
		300	5	-5	6	-31	1	-1	6	-31
		200	8	-9	7	-54	0	-1	9	-51
		150	13	-14	9	-69	0	-1	9	-69
100	15	-16	10	-83	1	-1	9	-80		
DARWIN 12 25'S 130 53'E 1467NM	JAKARTA 06 17'S 106 53'E	700	-3	1	9	8.9	5	-6	7	9.8
		500	5	-6	8	-6.0	7	-8	7	-5.0
		300	9	-10	7	-30.1	5	-6	9	-30.8
		200	20	-22	9	-53.3	2	-3	11	-54.0
		100	17	-19	11	-82.4	3	-4	11	-82.3
DARWIN 12 25'S 130 53'E 1127NM	LEARMONTH 22 14'S 114 05'E	700	5	-6	10	10.1	6	-7	9	9.0
		500	13	-14	9	-5.6	0	0	9	-5.7
		300	-1	0	10	-30.6	-17	16	13	-31.8
		200	-3	2	12	-52.4	-29	27	17	-53.8
		100	8	-10	12	-82.1	-16	14	12	-80.2
DARWIN 12 25'S 130 53'E 1434NM	PERTH 31 56'S 115 58'E	700	-3	2	7	10	0	-1	8	7
		500	-6	5	9	-7	-9	7	9	-9
		300	-12	11	12	-32	-21	18	11	-36
		200	-19	17	13	-53	-30	26	14	-54
		150	-15	13	11	-65	-26	22	13	-65
100	-8	7	9	-78	-15	14	10	-74		
DARWIN 12 25'S 130 53'E 982NM	PORT MORESY 09 16'S 147 13'E	700	-1	1	6	10	-5	5	6	9
		500	-3	3	8	-4	5	-6	7	-6
		300	0	0	8	-31	8	-8	9	-31
		200	10	-10	9	-53	11	-12	11	-52
		150	8	-8	11	-68	11	-11	11	-68
100	2	-3	11	-82	8	-8	10	-80		
DARWIN 12 25'S 130 53'E 1004NM	TOWNSVILLE 19 15'S 146 46'E	700	-3	7	7	10	-6	5	7	8
		500	1	-1	9	-5	7	-8	8	-6
		300	3	-4	10	-31	14	-15	12	-32
		200	17	-18	11	-52	23	-24	14	-53
		150	11	-12	12	-67	23	-23	13	-67
100	2	-3	11	-81	10	-11	12	-79		
DIEGO GARCIA 07 18'S 72 24'E 2568NM	LEARMONTH 22 14'S 114 05'E	700	-9	8	6	9.4	-5	4	6	9.1
		500	-9	8	6	-6.1	3	-4	6	-6.0
		300	4	-5	7	-32.4	23	-24	9	-31.9
		200	5	-6	8	-53.8	27	-28	11	-53.7
		100	-12	10	9	-79.9	10	-11	9	-79.8

ROUTE			DEC - FEB				MAR - MAY			
A	B	HPA	O	H	SD	T	O	H	SD	T
DIEGO GARCIA 07 18'S 72 24'E 2843NM	PERTH 31 56'S 115 58'E	700	-3	2	6	8.8	-1	0	7	7.2
		500	-1	0	7	-7.3	8	-9	7	-8.3
		300	8	-10	9	-33.7	25	-26	12	-34.2
		200	15	-17	12	-53.9	33	-35	14	-54.7
		100	-3	2	10	-76.4	10	11	10	-75.8
DIEGO GARCIA 07 18'S 72 24'E 1020NM	SEYCHELLES 04 40'S 55 31'E	700	-4	3	8	9.7	9	-10	7	10.2
		500	14	-15	8	-6.2	6	-7	7	-4.6
		300	13	14	8	-31.4	5	-6	10	-30.0
		200	13	-15	9	-53.2	3	-4	12	-51.5
		100	18	-20	13	-80.5	5	-6	12	-80.6
DIEGO GARCIA 07 18'S 72 24'E 1956NM	SINGAPORE 01 21'N 103 54'E	700	-3	2	6	8.7	-5	4	6	9.3
		500	-13	12	6	-6.4	-5	4	6	-5.5
		300	-14	13	6	-31.8	-6	5	8	-30.7
		200	-9	7	7	-54.3	-9	7	9	-53.2
		100	-16	14	10	-81.0	-8	7	10	-82.0
FIJI 17 45'S 177 27'E 2756NM	HONOLULU 21 21'N 157 56'W	700	-3	3	5	-10	-7	7	4	10
		500	1	-2	6	-9		1	5	-7
		300	8	-9	8	-32	7	-8	9	-33
		200	8	-10	10	-53	9	12	11	-54
		150	13	-15	9	-67	9	-11	9	-66
100	5	-6	8	-79	8		8	-78		
FIJI 17 45'S 177 27'E 2776NM	MIDWAY 28 15'N 177 22'W	700	-2	1	6	9	-3	3	4	9
		500	-1	-1	8	-5	0	0		-6
		300	1	-3	10	-33	-1	0	9	-53
		200	2	0	10	-53	-7	3	11	-54
		150	2	-5	9	-66	-4	1	10	-65
100	3	-4	8	-77	-1	-1	8	6		
GUAM 13 54'N 144 55'E 1787NM	DARWIN 12 25'S 130 53'E	700	0	-1	4	10	0	-1	5	10
		500	5	-6	6	-4	4	-4	5	-5
		300	3	-4	6	-31	2	-2	6	-31
		200	-1	1	6	-53	-3	2	8	-52
		150	0	-1	8	-68	0	0	8	-68
100	-3	2	9	-82	1	-2	8	-80		
GUAM 13 54'N 144 55'E 2691NM	FIJI 17 45'S 177 27'E	700	-1	1	4	11	-3	2	4	10
		500	-5	4	5	-4	-1	0	4	-5
		300	-1	0	7	-31	0	-1	6	-31
		200	0	0	7	-53	5	-5	8	-53
		150	-3	2	8	-68	3	-4	8	-67
100	-9	9	7	-81	0	0	7	-80		
HICKHAM 21 20'N 157 55'W 2123NM	BUCHOLZ 08 43'N 167 44'E	700	7	-8	7	10.4	6	-8	7	9.9
		500	-6	4	7	-5.3	-2	1	7	-5.4
		300	-17	15	9	-30.5	32	-31	11	-31.8
		200	-25	23	9	-53.4	-47	45	13	-54.3
		100	-17	15	9	-83.5	-22	21	10	-79.1

ROUTE		HPA	DEC - FEB				MAR - MAY			
A	B		O	H	SD	T	O	H	SD	T
HICKHAM 21 20'N 157 55'W 4058NM	TOWNSVILLE 19 15'S 146 46'E	700	4	-6	7	10.0	3	-4	5	9.6
		500	3	-4	7	-5.1	-2	1	5	-5.4
		300	-10	8	8	-30.5	-15	13	7	-31.4
		200	-6	5	8	-53.3	-20	18	9	-54.0
		100	3	-4	8	-84.0	-7	6	8	-80.7
HONG KONG 22 19'N 114 12'E 1044NM	BRUNEI 04 56'N 114 56'E	700	0	-1	6	9	-1	0	7	11
		500	-2	0	7	-6	1	-1	7	-5
		300	-2	-1	9	-31	-1	0	11	-30
		200	-2	0	10	-54	-2	0	12	-52
		150	-8	6	11	-66	6	-7	11	-66
100	-9	6	11	-79	-1	1	10	-79		
HONG KONG 22 19'N 114 21'E 1270NM	KUCHING 01 29'N 110 20'E	700	0	-1	6	9	0	0	7	11
		500	-1	0	7	-6	1	-1	6	-4
		300	-4	2	8	-31	-2	1	9	-30
		200	-4	2	9	-55	-3	1	11	-51
		150	-10	7	10	-67	4	-5	10	-66
100	-8	6	10	-80	-1	1	9	-79		
HONIARA 09 25'S 160 02'E 1131NM	FIJI 17 45'S 177 27'E	700	2	-2	7	10	-4	3	6	9
		500	3	-3	9	-4	8	-8	8	-6
		300	10	-11	12	-31	8	-9	11	-32
		200	20	-21	12	-53	17	-18	15	-53
		150	15	-15	13	-68	16	-17	13	-67
100	6	-6	11	-30	9	-9	10	-79		
HONOLULU 21 21'N 157 56'W 2270NM	PAGO PAGO 14 20'S 170 43'W	700	2	-2	5	10	5	-5	4	10
		500	-1	1	7	-6	1	-1	5	7
		300	-8	6	9	-32	-4	2	10	-33
		200	-5	3	11	-53	-7	4	12	-54
		150	-9	7	9	-66	-6	3	10	-66
100	-4	3	9	-80	-5	3	9	-78		
HONOLULU 21 21'N 157 56'W 2080NM	SAN FRANCISCO 37 37'N 122 23'W	700	6	-7	10	2	2	-3	8	3
		500	20	-23	13	-15	13	-15	11	-14
		300	37	-40	16	-41	26	-28	15	-40
		200	38	-44	17	-55	33	-36	16	-57
		150	33	-37	14	-60	31	-34	13	-60
100	18	-22	12	-66	18	-19	10	-63		
JAKARTA 06 09'S 106 51'E 483NM	SINGAPORE 01 21'N 103 54'E	700	-6	6	7	9	-1	1	8	10
		500	2	-2	8	-9	2	-2	7	-5
		300	3	-4	9	-31	1	-1	7	-30
		200	6	-7	10	-55	1	-2	11	-51
		150	11	-12	13	-69	1	-2	11	-68
100	9	-10	13	-83	1	-1	11	-80		

ROUTE		HPA	DEC - FEB				MAR - MAY			
A	B		O	H	SD	T	O	H	SD	T
JOHNSTON 16 44'N 169 31'W 2208NM	FIJI 17 45'S 177 27'E	700	2	-2	6	10	4	-5	4	10
		500	-1	0	7	-4	2	-2	5	-6
		300	-6	5	9	-32	-4	3	10	-32
		200	-5	3	11	-53	-6	3	12	-53
		150	10	8	10	-67	-6	4	10	-67
100	-4	4	8	-80	-6	5	9	-79		
JOHNSTON 16 44'N 169 31'W 814NM	MIDWAY 28 13'N 177 22'W	700	-3	2	14	5	0	-1	7	6
		500	-12	9	16	-10	-8	7	12	-9
		300	-25	20	21	-37	-18	16	19	-36
		200	-30	26	20	-52	-32	28	22	-55
		150	-28	26	17	-61	-31	29	18	-62
100	-16	15	13	-71	-16	15	14	-67		
KOTA KINABALU 05 56'N 116 03'E 434NM	KUCHING 01 29'N 110 20'E	700	9	-10	9	8.8	1	-2	9	9.3
		500	7	-8	9	-6.0	4	-6	8	-5.7
		300	9	-10	9	-30.5	6	-7	11	-30.5
		200	9	-11	10	-54.0	16	-3	13	-54.1
		100	11	-12	14	-81.7	2	-3	13	-82.3
KOTA KINABALU 05 56'N 116 03'E 592NM	MANILA 14 31'N 121 01'E	700	-8	6	9	8.9	-7	6	9	9.9
		500	-8	6	9	5.9	-3	2	8	-5.1
		300	-6	4	9	-30.4	0	-1	12	-31.0
		200	2	-3	10	-54.0	5	-6	15	-83.9
		100	0	-1	12	-81.9	6	-7	13	-81.8
KOTA KINABALU 05 56'N 116 03'E 778NM	SINGAPORE 01 21'N 103 54'E	700	9	-10	8	8.4	1	-2	9	9.3
		500	6	-8	8	-6.1	6	-7	8	-5.8
		300	10	-11	9	-31.0	7	-8	10	-30.9
		200	11	-12	12	-54.2	5	-6	12	-54.0
		100	10	-12	12	-81.5	3	-4	13	-82.3
KUALA LUMPUR 03 08'N 101 33'E 808NM	BRUNEI 04 56'N 114 56'E	700	-6	5	6	10	0	0	7	11
		500	-16	16	7	-5	-8	8	5	-4
		300	-13	13	7	-31	-9	9	6	-30
		200	-18	18	8	-55	-11	11	10	-51
		150	-27	27	11	-69	-13	12	10	-68
100	-31	30	12	-82	-11	11	10	-81		
KUALA LUMPUR 03 08'N 101 33'E 1335NM	COLOMBO 06 54'N 79 52'E	700	7	-7	6	10	6	-6	6	10
		500	14	-15	5	-5	7	-8	6	-5
		300	3	-3	8	-31	5	-5	7	-29
		200	9	-10	10	-55	7	-8	9	-51
		150	19	-20	11	-69	9	-10	9	-67
100	20	-20	11	-82	8	-9	8	-78		
KUALA LUMPUR 03 08'N 101 33'E 177NM	SINGAPORE 01 21'N 103 54'E	700	0	-1	8	9	2	-3	8	10
		500	-11	11	9	5	-5	5	7	-4
		300	-8	8	9	-31	-7	7	8	-30
		200	-13	13	11	-55	-8	8	12	-51
		150	-25	25	14	-69	-9	8	11	-68
100	-26	25	15	-83	-7	7	12	-80		

ROUTE		HPA	DEC - FEB				MAR - MAY			
A	B		O	H	SD	T	O	H	SD	T
KUCHING 01 29'N 110 20'E 346NM	BRUNEI 04 56'N 114 56'E	700	-2	2	7	10	1	-1	8	11
		500	-12	11	8	-5	-7	7	6	-4
		300	-13	12	8	-31	-8	8	6	-30
		200	-17	16	9	-55	-10	10	11	-51
		150	-20	18	2	-69	-11	11	11	-68
100	-20	18	-2	-82	-10	9	11	-81		
KUCHING 01 29'N 110 20'E 386NM	SINGAPORE 01 21'N 103 54'E	700	0	0	9	8.6	-3	2	9	8.9
		500	0	0	9	-6.1	4	-5	8	-6.1
		300	11	-12	10	-30.9	9	-10	11	-30.9
		200	11	-12	12	-54.2	9	-10	12	-53.9
		100	11	-12	13	-81.3	6	-7	13	-82.3
LEARMONTH 22 14'S 114 05'E 1045NM	JAKARTA 06 16'S 106 53'E	700	4	-5	9	9.4	0	-1	8	9.5
		500	3	-4	9	-6.0	-3	2	8	-6.0
		300	0	0	11	-31.0	-13	11	12	-32.0
		200	-5	4	13	53.3	-17	14	15	-54.0
		100	-2	1	13	-82.1	-11	10	12	-80.6
LEARMONTH 22 14'S 114 05'E 2071NM	SYDNEY 33 56'S 151 10'E	700	-1	0	8	8.1	5	-7	9	4.0
		500	7	-9	9	-8.7	19	-20	11	-11.7
		300	22	-23	12	-35.1	39	-41	18	-38.3
		200	36	-38	16	-53.4	55	-57	20	-55.6
		100	16	-17	11	-74.0	31	-33	12	-70.4
MADRAS 13 00'N 80 11'E 1407NM	KUALA LUMPUR 03 08'N 101 33'E	700	-6	6	6	10	-5	5	6	10
		500	-12	12	7	-5				
		300	-1	0	8	-32	1	-2	9	-29
		200	-5	4	11	-56	-1	0	10	-51
		150	-8	7	11	-69	-2	1	9	-67
100	-14	13	11	-81	-3	2	8	-78		
MAURITIUS 20 26'S 57 40'E 2302NM	COCOS 12 11'S 96 50'E	700	-3	3	6	9	-9	9	6	8
		500	-3	2	9	-6	8	-9	7	-7
		300	5	-7	10	-31	15	-16	9	-33
		200	9	-11	11	-33	20	-22	10	-53
		150	6	-7	9	-66	20	-21	9	-66
100	-5	4	7	-78	16	-17	8	-75		
MAURITIUS 20 26'S 57 40'E 3177NM	PERTH 31 56'S 115 58'E	700	3	-4	8	7	6	-7	7	4
		500	13	-14	8	-9	16	-17	8	-12
		300	26	-26	10	-34	34	-36	11	-38
		200	28	-29	10	-63	42	-44	12	-55
		150	26	-27	10	-63	38	-40	11	-62
100	9	-10	7	-70	26	-27	9	-68		
MIDWAY 28 13'N 177 22'W 1134NM	HONOLULU 21 21'N 157 56'W	700	4	-6	13	4	-2	2	7	5
		500	20	-22	15	-11	11	-12	11	-10
		300	39	-42	21	-38	20	-22	17	-37
		200	46	-48	19	-52	39	-41	21	-56
		150	41	-43	15	-61	39	-40	17	-63
100	25	-26	12	-69	21	-22	12	-65		

ROUTE			DEC - FEB				MAR - MAY			
A	B	HPA	O	H	SD	T	O	H	SD	T
NADI 17 45'S 177 26'E 1710NM	SYDNEY 33 56'S 151 10'E	700	-1	0	9	7.8	-8	6	10	4.4
		500	-9	7	11	-7.5	-16	14	12	-11.2
		300	-27	24	16	-33.4	-38	33	19	-37.5
		200	-33	30	20	-53.4	-50	45	21	-54.6
		100	-14	12	12	-74.7	-25	23	13	-69.4
PAGO PAGO 14 20'S 170 43'W 439NM	FIJI 17 45'S 177 27'E	700	0	0	8	10	4	-4	7	10
		500	-8	7	11	-5	-7	7	9	-6
		300	-19	18	15	-31	-14	13	14	-32
		200	-28	27	17	-53	-23	21	19	-53
		150	-27	26	17	-67	-22	22	17	-67
100	-16	15	13	-80	-15	15	13	-78		
PERTH 31 56'S 115 58'E 2046NM	BRISBANE 27 25'S 155 05'E	700	9	-10	7	7	10	-11	8	2
		500	16	-17	8	-10	10	-21	10	-14
		300	29	-30	11	-36	43	-45	13	-36
		200	40	-41	14	-53	55	-57	16	-55
		150	36	-37	13	-62	53	-55	14	-62
100	16	-17	10	-71	35	-36	12	-66		
PERTH 31 56'S 115 58'E 3756NM	SEYCHELLES 04 40'S 55 31'E	700	1	-1	5	8	2	-3	5	6
		500	-4	4	7	-7	-10	9	6	-9
		300	-12	11	8	-32	-23	21	8	-35
		200	-14	13	10	-54	-28	27	9	-53
		150	-12	11	8	-65	-25	24	8	-65
100	-1	0	6	-75	-18	17	7	-73		
PERTH 31 56'S 115 58'E 2111NM	SINGAPORE 01 21'N 103 54'E	700	0	-1	6	9	0	-1	6	8
		500	-1	1	7	-6	-2	2	7	-8
		300	-1	0	8	-32	-8	5	9	-34
		200	-3	1	10	-54	-8	5	11	-53
		150	0	-1	10	-67	-7	5	11	-66
100	4	-5	8	-80	-5	3	9	-76		
PERTH 31 56'S 115 58'E 1768NM	SYDNEY 33 56'S 151 10'E	700	8	-9	10	6.2	13	-14	11	2.0
		500	17	-18	12	-10.6	24	-25	13	-14.5
		300	31	-32	16	-37.7	39	-41	20	-41.3
		200	42	-44	20	-54.7	49	-51	22	-56.9
		100	22	-23	12	-68.7	28	-29	12	65-.9
PERTH 31 56'S 115 58'E 1823NM	TOWNSVILLE 19 15'S 146 46'E	700	8	-8	7	9	2	-3	7	4
		500	12	-13	8	-8	14	-15	9	-11
		300	23	-23	10	-33	40	-42	12	-37
		200	33	-34	13	-53	51	-54	15	-55
		150	28	-29	12	-64	45	-47	14	-64
100	11	-11	10	-74	26	-28	13	-71		
PERTH 31 56'S 115 58'E 1066NM	WOOMERA 31 09'S 136 49'E	700	9	-10	10	7.5	11	-13	13	3.6
		500	21	-22	13	-9.8	25	-27	14	-13.0
		300	33	-34	17	-36.4	43	-45	23	-39.6
		200	48	-50	22	-54.1	57	-59	25	-56.7
		100	25	-26	15	-71.0	30	-32	14	-68.7

ROUTE		HPA	DEC - FEB				MAR - MAY			
A	B		O	H	SD	T	O	H	SD	T
PORT MORESBY 09 26'S 147 13'E 1387NM	GUAM 13 34'N 144 55'E	700	-1	0	4	11	0	0	5	11
		500	2	-3	6	-3	-1	1	5	-5
		300	0	-1	6	-31	3	-3	6	-31
		200	6	-6	7	-53	6	-6	9	-52
		150	7	-8	8	-68	4	-4	9	-67
100	14	-15	9	-81	2	-3	9	-80		
PORT MORESBY 09 26'S 147 13'E 759NM	HONIARA 09 25'S 160 02'E	700	4	-5	6	10	-4	4	6	9
		500	-1	1	8	-4	5	-5	7	-6
		300	2	-3	10	-31	6	-7	9	-31
		200	9	-9	10	-53	11	-11	12	-51
		150	8	-8	12	-68	10	-10	12	-68
100	3	-3	12	-82	8	-8	11	-80		
PORT MORESBY 09 26'S 147 13'E 2663NM	SINGAPORE 01 21'N 103 54'E	700	-6	5	4	10	-3	3	4	10
		500	7	-7	5	-4	3	-4	4	-5
		300	6	-6	5	-31	2	-2	4	-31
		200	9	-9	5	-54	0	0	7	-51
		150	13	-14	7	-69	0	0	7	-69
100	17	-17	8	-83	1	-2	6	-80		
SEYCHELLES 04 40'S 55 31'E 1615NM	COLOMBO 06 54'N 79 52'E	700	-5	5	6	9	-8	8	5	9
		500	-9	8	8	-5	-8	7	5	-5
		300	-5	5	9	-30	-3	3	6	-29
		200	-5	4	11	-54	-6	5	8	-51
		150	-7	6	12	-69	-6	6	8	-67
100	-7	6	10	-81	-7	7	7	-78		
SEYCHELLES 04 40'S 55 31'E 2908NM	SINGAPORE 01 21'N 103 54'E	700	3	-3	4	9	-5	4	4	9
		500	-9	9	6	-5	-8	7	4	-5
		300	-9	8	7	-30	-5	5	5	-30
		200	-10	9	8	-54	-6	5	6	-51
		150	-15	14	9	-69	-6	6	6	-67
100	-14	14	7	-82	-9	9	6	-78		
SINGAPORE 01 21'N 103 54'E 770NM	BANGKOK 13 44'N 100 30'E	700	1	-1	6	9	-2	1	7	11
		500	3	-4	8	-5	1	-2	7	-4
		300	0	-1	9	-31	0	-1	9	-29
		200	1	-2	10	-55	0	-1	11	-51
		150	6	-7	11	-68	0	-1	10	-67
100	9	-12	11	-81	1	-1	11	-80		
SINGAPORE 01 21'N 103 54'E 690NM	BRUNEI 04 56'N 114 56'E	700	-3	3	6	10	1	-1	7	11
		500	-14	14	7	-5	-7	7	6	-4
		300	-13	13	8	-31	-9	9	6	-30
		200	-19	19	8	-55	-11	11	10	-51
		150	-26	25	11	-69	-12	12	10	-68
100	-29	28	12	-82	-11	10	10	-81		

ROUTE		HPA	DEC - FEB				MAR - MAY			
A	B		O	H	SD	T	O	H	SD	T
SINGAPORE 01 21'N 103 54'E 1285NM	CLARK 15 10'N 120 34'E	700	-5	5	5	10	-4	4	6	11
		500	-11	10	6	-5	-8	7	5	-4
		300	-5	5	7	-31	-4	4	7	-30
		200	-6	6	8	-55	-7	7	9	-51
		150	-6	5	9	-68	-10	9	9	-67
100	-13	12	9	-81	-8	7	9	-80		
SINGAPORE 01 21'N 103 54'E 915NM	COCOS 12 11'S 96 50'E	700	-2	3	7	9	-2	2	7	9
		500	4	-5	8	-5	2	-2	7	-5
		300	3	-3	9	-31	0	0	7	-31
		200	2	-3	11	-55	0	-1	10	-51
		150	1	-2	11	-69	0	-1	10	-68
100	3	-6	12	-83	0	-1	10	-79		
SINGAPORE 01 21'N 103 54'E 1803NM	DARWIN 12 26'S 130 52'E	700	8	-8	7	10	1	-2	5	10
		500	-6	6	6	-5	-3	3	5	-5
		300	-4	4	6	-31	1	-1	6	-31
		200	-9	8	7	-54	1	-1	8	-52
		150	-10	9	9	-69	1	-1	8	-68
100	-16	14	9	-83	0	-1	8	-80		
SINGAPORE 01 21'N 103 54'E 1391NM	HONG KONG 22 19'N 114 12'E	700	-1	0	6	8	-1	1	6	11
		500	0	-1	7	-6	-2	1	6	-4
		300	5	-7	8	-31	3	-4	9	-30
		200	6	-8	9	-55	3	-5	10	-51
		150	10	-12	10	-67	-3	2	10	-66
100	6	-8	10	-80	2	-2	9	-79		
SINGAPORE 01 21'N 103 54'E 3396NM	SYDNEY 33 56'S 151 10'E	700	-4	3	6	8.3	-2	1	6	6.7
		500	-1	0	7	-7.1	2	-3	7	-8.5
		300	4	-5	9	-32.4	10	-12	11	-34.5
		200	4	-6	9	-53.3	18	-20	13	-54.6
		100	0	0	9	-77.9	11	-12	9	-76.1
SYDNEY 33 56'S 151 10'E 1166NM	AUCKLAND 37 01'S 174 47'E	700	7	-8	12	4.7	7	-9	12	0.9
		500	17	-18	13	-12.4	19	-20	17	-15.4
		300	34	-36	19	-37.0	34	-36	24	-42.3
		200	42	-44	23	-55.9	42	-44	26	-55.9
		100	23	-24	13	-65.0	28	-29	14	-62.8
SYDNEY 33 56'S 151 10'E 1701NM	DARWIN 12 25'S 130 53'E	700	9	-10	10	7.9	2	-4	9	5.2
		500	0	-1	10	-69	-8	6	10	-9.7
		300	-13	11	12	-32.4	-28	24	16	-36.0
		200	-19	16	15	-52.5	-40	36	19	-54.7
		100	-7	6	12	-77.3	-23	22	12	-73.4
SYDNEY 33 56'S 151 10'E 912NM	TOWNSVILLE 19 15'S 146 46'E	700	5	-6	10	6.7	1	-3	11	3.6
		500	-3	1	13	-8.5	-4	11	4	-11.6
		300	-7	3	15	-34.5	-15	8	22	-38.0
		200	-14	9	21	-53.0	-23	14	25	-54.8
		100	-6	4	14	-75.0	-14	10	15	-69.9

ROUTE			DEC - FEB				MAR - MAY			
A	B	HPA	O	H	SD	T	O	H	SD	T
TOWNSVILLE 19 15'S 146 46'E 1229NM	BAUERFILED 17 42'S 168 19'E	700	4	-5	7	10	-3	3	7	8
		500	7	-8	9	-6	9	-10	9	-7
		300	14	-15	11	-32	24	-25	12	-33
		200	37	-37	11	-52	40	-41	15	-53
		150	23	-24	13	-66	33	-34	14	-66
100	8	-9	11	-79	17	-17	12	-77		
TOWNSVILLE 19 15'S 146 46'E 970NM	HONIARA 09 25'S 160 02'E	700	1	-2	7	10	-6	5	7	8
		500	5	-6	9	-4	6	-6	8	-6
		300	5	-5	11	-31	11	-12	11	-32
		200	21	-22	10	-52	19	-20	14	-52
		150	13	-14	12	-68	18	-19	13	-67
100	7	-8	12	-80	8	-9	12	-79		
TOWNSVILLE 19 15'S 146 46'E 590NM	PORT MORESBY 09 26'S 147 13'E	700	1	-1	8	10	-1	1	7	8
		500	4	-4	9	-5	0	-1	9	-6
		300	0	-1	11	-31	2	-4	12	-32
		200	5	-6	11	-52	2	-4	15	-52
		150	2	-3	13	-67	1	-2	14	-67
100	5	-6	13	-81	0	-1	13	-79		
WILLIAMTOWN 32 48'S 151 50'E 1088NM	ALICE SPRINGS 23 49'S 133 54'E	700	2	-4	10	7.0	-4	2	11	2.6
		500	-12	10	12	-9.5	17	-15	14	-13.1
		300	-25	23	18	-35.6	-38	35	22	-39.6
		200	-37	35	22	-53.8	-53	49	25	-55.7
		100	-19	17	14	-72.0	-30	29	14	-68.0
WILLIAMTOWN 32 48'S 151 50'E 392NM	EAST SALE 38 06'S 147 09'E	700	-12	10	13	3.5	-12	9	15	-0.7
		500	-16	13	17	-12.3	-13	10	20	-16.9
		300	-26	22	25	-39.1	-25	20	28	-43.9
		200	-25	21	28	-55.9	-26	21	31	-56.9
		100	-14	12	16	-64.3	-15	13	15	-61.1
WILLIAMTOWN 32 48'S 151 50'E 669NM	EDINBURGH 34 42'S 138 37'E	700	-10	8	12	5.0	-14	13	13	0.4
		500	-18	17	16	-11.4	-23	21	18	-15.8
		300	-32	30	21	-38.5	-39	37	26	-42.8
		200	-42	40	25	-55.1	-46	44	28	-56.8
		100	-24	23	15	-66.3	-28	27	15	-63.3
WILLIAMTOWN 32 48'S 151 50'E 982NM	MOUNT ISA 20 40'S 139 29'E	700	7	-8	10	7.0	0	-1	11	3.6
		500	-5	4	11	-8.3	-12	10	14	-11.6
		300	-20	17	17	-34.0	-33	29	21	-38.0
		200	-30	26	21	-53.2	-48	42	24	-55.0
		100	-13	11	14	-75.0	-28	26	15	-70.1
WILLIAMTOWN 32 48'S 151 50'E 770NM	WOOMERA 31 09'S 136 49'E	700	-6	5	11	6.2	-11	9	13	1.4
		500	-13	12	14	-9.8	-22	20	16	-14.6
		300	-30	28	19	-36.7	-40	38	24	-41.5
		200	-44	42	23	-54.3	-52	50	27	-56.4
		100	-20	18	14	-70.2	-31	29	15	-65.5

1.3 Mean Equivalent Wind Table (Jun-Nov)

ROUTE		HPA	JUN - AUG				SEP - NOV			
A	B		O	H	SD	T	O	H	SD	T
ADELAIDE 34 57'S 138 32'E 3099NM	BUCHHOLZ 08 43'N 167 44'E	700	4	-5	7	5.9	1	-2	7	7.0
		500	10	-12	9	-9.4	7	-9	8	-8.3
		300	23	-25	11	-34.1	15	-17	11	-34.1
		200	27	-29	12	-54.2	22	-24	12	-53.7
		100	12	-13	9	-74.3	7	-9	9	-75.1
ADELAIDE 34 57'S 138 32'E 524NM	CANBERRA 35 18'S 149 12'E	700	11	-12	12	-5	20	-21	14	-2
		500	27	-28	17	-22	31	-32	18	-18
		300	47	-50	27	-48	46	-48	26	-44
		200	57	-59	27	-53	50	-52	25	-53
		150	61	-62	23	-56	46	-48	22	-56
100	41	-41	16	-58	31	-51	16	-58		
ADELAIDE 34 57'S 138 32'E 1415NM	DARWIN 12 25'S 130 53'E	700	-3	1	11	2.3	-1	0	11	4.4
		500	-6	3	14	-12.9	-6	3	14	-11.2
		300	-19	10	21	-36.7	-16	9	19	-36.5
		200	-23	12	22	-53.6	-17	10	20	-53.4
		100	-15	12	13	-70.1	-5	2	13	-71.2
ADELAIDE 34 57'S 138 32'E 1491NM	LEARMONTH 22 14'S 114 05'E	700	-17	16	11	0.4	-18	16	12	3.0
		500	-31	28	16	-15.4	-29	27	15	-13.2
		300	-68	61	24	-38.5	-54	50	22	-38.6
		200	-76	70	25	-53.0	-64	60	22	-53.2
		100	-41	39	15	-67.5	-27	26	14	-67.9
ADELAIDE 34 57'S 138 32'E 1259NM	MACQUARIE ISLAND 54 40'S 148 52'E	700	9	-13	16	-8.9	10	-14	16	-6.6
		500	11	-15	20	-26.1	12	-17	21	-22.7
		300	15	-22	25	-51.6	18	-25	27	-47.6
		200	17	-23	22	-56.1	20	-26	24	-52.9
		100	21	-27	13	-55.5	17	-21	14	-52.5
ADELAIDE 34 57'S 138 32'E 1141NM	PERTH 31 56'S 115 58'E	700	-21	23	12	-4	-20	21	12	0
		500	-27	30	15	-21	-37	39	15	-17
		300	-50	53	22	-45	-50	53	23	-43
		200	-59	63	19	-53	-57	61	22	-52
		150	-61	63	17	-57	-53	55	17	-58
100	-37	40	15	-60	-35	37	12	-61		
ADELAIDE 34 57'S 138 32'E 1039NM	TOWNSVILLE 19 15'S 146 46'E	700	8	-10	13	-0.4	7	-9	13	2
		500	17	-22	17	-15.8	14	-17	17	-13
		300	27	-43	27	-38.6	21	-31	24	-38
		200	34	-51	28	-52.9	25	-36	25	-53
		100	15	-20	16	-66.2	12	-15	15	-67
ALICE SPRINGS 23 49'S 133 54'E 1042NM	AMBERLEY 27 39'S 152 43'E	700	13	-15	13	-0.8	12	-14	13	2
		500	32	-35	17	-16.0	27	-29	16	-13
		300	75	-81	29	-38.0	56	-60	24	-38
		200	88	-94	29	-52.8	68	-72	25	-53
		100	49	-51	17	-66.5	30	-31	16	-67

ROUTE			JUN - AUG				SEP - NOV			
A	B	HPA	O	H	SD	T	O	H	SD	T
ALICE SPRINGS 23 49'S 133 54'E 1098NM	LEARMONTH 22 14'S 114 05'E	700	-15	14	11	3.7	-14	13	11	6
		500	-36	35	16	-10.3	-30	28	14	-9
		300	-76	74	24	-33.8	-60	58	21	-34
		200	-77	75	24	-53.9	-72	71	22	-53
		100	-45	43	16	-74.0	-32	31	15	-74
ALICE SPRINGS 23 49'S 133 54'E 1151NM	PORT MORESBY 09 27'S 147 13'E	700	4	-6	10	6.6	4	-5	10	7
		500	15	-18	14	-8.2	13	-14	12	-7
		300	31	-35	18	-32.5	28	-28	17	-33
		200	31	-35	19	-54.6	26	-30	18	-53
		100	13	-15	14	-76.2	8	-10	13	-77
AUCKLAND 36 51'S 174 46'E 411NM	CHRISTCHURCH 43 29'S 172 32'E	700	-7	4	16	-7	-5	21	7	-4
		500	-7	4	18	-25	-6	2	20	-21
		300	-13	6	27	-51	-10	5	28	-47
		200	-14	8	21	-54	-9	4	24	-53
		150	-15	10	15	-55	-9	6	17	-53
100	-12	8	13	-55	-5	4	12	-54		
AUCKLAND 36 51'S 174 46'E 1155NM	FIJI 17 45'S 177 27'E	700	1	-2	10	1	0	-1	10	3
		500	1	-6	13	-15	0	-1	13	-15
		300	3	-14	19	-40	2	-10	21	-40
		200	2	-15	18	-54	3	-14	20	-54
		150	4	-14	15	-61	3	-10	15	-61
100	1	-5	13	-65	4	-6	10	-65		
BAUERFIELD 17 42'S 168 19'E 522NM	FIJI 17 45'S 177 27'E	700	1	-1	9	7	6	-7	8	7
		500	21	-21	12	-8	14	-15	11	-9
		300	39	-40	17	-34	37	-38	17	-34
		200	45	-46	18	-54	44	-45	20	-55
		150	43	-44	17	-67	41	-42	17	-66
100	20	-20	11	-74	18	-18	12	-74		
BRISBANE 27 25'S 153 05'E 872NM	ADELAIDE 34 57'S 138 32'E	700	-14	13	12	-3	-14	13	11	0
		500	-29	25	16	-19	-13	11	9	-17
		300	-52	48	23	-44	-46	41	25	-42
		200	-65	60	21	-54	-53	49	22	-54
		150	-61	58	19	-59	-47	44	16	-59
100	-33	30	15	-62	-27	25	12	-63		
BRISBANE 27 25'S 153 05'E 1234NM	AUCKLAND 36 51'S 174 46'E	700	11	-12	11	-3	11	-12	11	0
		500	26	-29	14	-20	23	-26	15	-18
		300	49	-54	20	-45	40	-44	23	-43
		200	61	-65	19	-53	45	-49	20	-54
		150	54	-57	15	-58	40	-42	15	-58
100	37	-38	13	-61	20	-21	10	-61		
BRISBANE 27 25'S 153 05'E 2392NM	BUCHOLZ 08 43'N 167 44'E	700	0	1	7	8.4	0	-1	7	8.7
		500	0	-2	9	6.8	0	-1	8	-6.3
		300	7	-9	10	-32.0	3	-5	11	-32.2
		200	9	-11	12	-54.6	8	-10	12	-53.9
		100	2	-3	9	-77.3	0	-1	10	-78.0

ROUTE			JUN - AUG				SEP - NOV			
A	B	HPA	O	H	SD	T	O	H	SD	T
BRISBANE 27 25'S 153 05'E 1347NM	CHRISTCHURCH 43 29'S 172 32'E	700	8	-10	11	-5	10	-12	12	-2
		500	17	-20	13	-22	18	-21	15	-19
		300	30	-36	20	-47	26	-31	21	-44
		200	38	-44	20	-54	32	-37	20	-53
		150	37	-42	16	-56	27	-30	16	-56
		100	28	-30	12	-59	15	-17	12	-58
BRISBANE 27 25'S 153 05'E 1560NM	DARWIN 12 25'S 130 53'E	700	-3	3	7	5	-5	5	7	6
		500	-23	20	11	-10	-13	11	1	-10
		300	-46	42	15	-35	-35	33	14	-35
		200	-48	43	16	-34	-12	38	14	-54
		150	-44	39	13	-65	-36	33	11	-66
		100	-37	33	11	-74	-16	14	9	-74
BRISBANE 27 25'S 153 05'E 1149NM	HONIARA 09 25'S 160 02'E	700	3	-5	10	6.9	3	-4	10	7.2
		500	4	-9	14	-7.9	3	-6	12	-7.4
		300	9	-18	18	-33.1	10	-16	17	-33.5
		200	15	-23	19	-54.5	15	-21	18	-53.8
		100	8	-10	14	-75.8	6	-8	13	-76.2
BRISBANE 27 25'S 153 05'E 1465NM	NADI 17 45'S 177 26'E	700	16	-17	10	-4.1	13	-14	10	5.6
		500	40	-43	15	-10.4	30	-32	13	-9.5
		300	77	-81	22	-34.4	61	-64	19	-35.2
		200	85	-88	23	-53.9	61	-63	20	-53.6
		100	43	-45	15	-72.1	36	-38	14	-71.4
BRISBANE 27 25'S 153 05'E 601NM	TOWNSVILLE 19 15'S 146 46'E	700	-6	5	9	4	-5	4	10	5
		500	-22	18	18	-12	-15	15	14	-12
		300	-46	34	22	-37	-36	28	20	-36
		200	-46	35	22	-54	-39	30	24	-54
		150	-36	28	20	-64	-34	28	21	-64
		100	-25	22	17	-71	-12	10	17	-71
BUCHOLZ 08 43'N 167 44'E 1374NM	GUAM 13 34'N 144 55'E	700	9	-9	5	10	10	-10	5	11
		500	10	-10	6	-5	10	-10	6	-5
		300	-2	1	7	-31	6	-6	8	-31
		200	-6	6	11	-54	1	-2	11	-54
		150	-2	1	10	-66	0	0	10	-68
		100	11	-11	8	-78	10	-11	9	-77
BUCHOLZ 08 43'N 167 44'E 1414NM	JOHNSTON 16 44'N 169 31'W	700	-10	10	4	10	-10	9	4	10
		500	-9	9	6	-5	-9	9	6	-5
		300	8	-8	8	-32	0	-1	10	-32
		200	12	-13	12	-55	11	-12	12	-10
		150	10	-11	10	-67	15	-15	12	-67
		100	-4	4	7	-77	-5	4	10	-75
BUCHOLZ 08 43'N 167 44'E 1689NM	FIJI 17 45'S 177 27'E	700	-5	5	5	9	-2	1	4	10
		500	2	2	6	-6	-2	1	5	-6
		300	1	-2	8	-32	1	-2	8	-32
		200	1	-3	11	-55	2	-3	10	-54
		150	1	-2	10	-69	3	-4	10	-69
		100	3	-4	7	-78	2	-3	9	-79

GEN 3.5

ROUTE		HPA	JUN - AUG				SEP - NOV			
A	B		O	H	SD	T	O	H	SD	T
BUCHOLZ 08 43'N 167 44'E 1640NM	PORT MORESBY 09 26'S 147 13'E	700	5	-6	4	10	5	-5	4	10
		500	6	-7	6	-5	6	-6	4	-5
		300	2	-2	6	-32	5	-5	6	-31
		200	1	-1	10	-55	-1	0	8	-54
		150	-2	1	10	-69	-4	4	8	-70
100	-4	3	8	-79	1	-2	9	-80		
BUTTERWORTH 05 28'N 100 24'E 507NM	BANGKOK 13 55'N 100 37'E	700	7	-9	9	10.4	-1	0	9	9.5
		500	6	-7	11	-4.9	0	0	10	-5.6
		300	0	-1	10	-30.3	0	-2	13	-30.9
		200	2	-1	12	-54.1	-4	1	14	-54.3
		100	-9	3	11	-78.3	-3	0	16	-80.1
BUTTERWORTH 05 28'N 100 24'E 935NM	KOTA KINABALU 05 56'N 116 03'E	700	4	-5	6	10.2	7	-8	7	9.2
		500	-10	9	9	-5.4	-8	7	7	-5.9
		300	-20	19	9	-31.1	-10	9	10	-31.1
		200	-39	37	10	-54.4	-27	25	12	-54.4
		100	-45	44	10	-78.7	-34	33	12	-80.3
BUTTERWORTH 05 28'N 100 24'E 324NM	SINGAPORE 01 21'N 103 54'E	700	0	-1	7	9.1	2	-4	8	8.7
		500	-9	7	10	-6.3	-5	4	8	-6.2
		300	-16	14	10	-31.8	-7	5	11	-31.5
		200	-23	20	11	-54.3	-12	10	13	-54.2
		100	-25	21	11	-78.1	-22	20	13	-80.2
CALCUTTA 22 39'N 88 27'E 1398NM	KUALA LUMPUR 03 07'N 101 33'E	700	4	-5	6	10	-6	5	6	9
		500	-4	4	6	-4	-3	3	6	-5
		300	-10	9	6	-29	-3	3	8	-31
		200	-19	17	9	-53	-5	4	9	-54
		150	-25	22	10	-67	-9	8	10	-68
100	-25	22	10	-78	-15	13	9	-79		
CANBERRA 35 18'S 149 12'E 1240NM	AUCKLAND 36 51'S 174 46'E	700	11	-13	11	-6	15	-17	13	-3
		500	24	-25	14	-23	25	-27	26	-20
		300	44	-47	21	-49	35	-28	32	-45
		200	56	-58	20	-53	43	-45	20	-53
		150	57	-58	15	-55	38	-39	16	-55
100	41	-42	12	-57	22	-23	11	-57		
CANBERRA 35 18'S 149 12'E 518NM	BRISBANE 27 25'S 153 05'E	700	4	-5	12	-3	5	-7	13	0
		500	10	-14	16	-19	10	-14	18	-17
		300	17	-28	27	-44	10	-24	26	-42
		200	21	-34	30	-54	17	-26	27	-54
		150	21	-51	26	-59	17	-23	23	-59
100	13	-17	18	-62	11	-13	17	-62		
CANBERRA 35 18'S 149 12'E 1183NM	CHRISTCHURCH 43 29'S 172 32'E	700	11	-13	12	-7	16	-18	13	-4
		500	20	-21	14	-25	23	-25	16	-20
		300	32	-35	20	-51	30	-33	22	-46
		200	41	-43	18	-54	37	-39	19	-53
		150	44	-45	14	-54	30	-32	15	-53
100	37	-38	11	-56	19	-19	11	-55		

ROUTE		HPA	JUN - AUG				SEP - NOV			
A	B		O	H	SD	T	O	H	SD	T
CHRISTCHURCH 43 29'S 177 32'E	McMURDO 77 53'S 166 48'E	700	-4	0	10	-16	-1	-3	9	-15
		500	-6	0	13	-31	-1	4	12	-30
		300	-3	-2	17	-56	-3	-2	17	-53
		200	-7	1	15	-61	-1	-5	13	-56
		150	-3	-1	11	-60	-1	1	11	-52
2080NM		100	-7	1	9	-61	-3	-3	9	-51
COCOS 12 12'S 96 50'E	DARWIN 12 25'S 130 53'E	700	-5	4	6	8	-6	6	5	8
		500	4	-5	8	-7	-4	4	6	7
		300	16	-17	8	-33	11	-12	8	-33
		200	16	-17	12	-54	15	-16	9	-54
		150	5	-6	11	-68	10	-11	9	-68
1995NM		100	23	-24	9	-77	7	-8	8	-78
COCOS 12 12'S 96 50'E	DIEGO GARCIA 07 18'S 72 24'E	700	6	-7	7	8.6	6	-7	7	8.0
		500	3	-4	8	-6.2	8	-9	7	-5.8
		300	1	-2	9	-32.2	0	-1	9	-32.4
		200	4	-5	10	-54.8	-7	6	11	-53.9
		100	19	-20	9	-77.3	11	-12	10	-78.7
1474NM										
COCOS 12 12'S 96 50'E	LEARMONTH 22 14'S 114 05'E	700	1	-2	9	7.3	2	-3	9	8.2
		500	13	-14	12	-6.7	3	-4	11	-6.6
		300	25	-27	14	-32.7	20	-22	15	-32.6
		200	17	-19	16	-54.7	29	-31	16	-53.8
		100	9	-10	12	-77.8	5	-6	12	-78.6
1156NM										
COCOS 12 12'S 96 50'E	PERTH 31 56'S 115 58'E	700	4	-5	8	4	3	-4	8	6
		500	10	-13	11	-11	13	-15	9	-11
		300	29	-34	15	-36	29	-33	15	-36
		200	33	-39	16	-53	31	-35	16	-54
		150	22	-27	14	-64	25	-28	13	-65
1586NM		100	16	-22	13	-71	12	-15	9	-71
COCOS 12 12'S 96 50'E	SEYCHELLES 04 40'S 55 31'E	700	6	-7	5	8.4	6	-7	5	8.1
		500	2	-3	7	-6.2	8	-9	6	-5.8
		300	1	-2	7	-31.5	1	-2	8	-32.0
		200	5	-6	9	-54.4	-7	6	9	-54.0
		100	18	-19	8	-77.1	9	-10	8	-78.0
2490NM										
COLOMBO 06 54'N 79 52'E	COCOS 12 12'S 96 50'E	700	3	-3	5	8	1	-2	6	-9
		500	-4	3	6	-5	-5	5	5	-6
		300	-6	5	6	-31	-3	3	7	-33
		200	-13	11	10	-55	-1	1	8	-54
		150	-17	16	10	-68	-15	13	10	-70
1529NM		100	-18	16	10	-78	-19	15	9	-80
DARWIN 12 25'S 130 53'E	ADELAIDE 34 57'S 138 32'E	700	2	-3	8	3	2	-3	8	5
		500	5	-10	12	-13	4	-8	11	-12
		300	9	-19	17	-38	8	-16	17	-37
		200	10	-22	17	-54	6	-16	16	-54
		150	8	-18	15	-63	10	-16	12	-64
1415NM		100	8	-14	12	-70	3	-7	9	-70

GEN 3.5

ROUTE		HPA	JUN - AUG				SEP - NOV			
A	B		O	H	SD	T	O	H	SD	T
DARWIN 12 25'S 130 53'E 2188NM	BAUERFIELD	700	0	-1	5	8	3	-4	5	8
	17 42'S 168 19'E	500	14	-14	7	-7	8	-9	7	-7
		300	30	-31	10	-33	27	-28	9	-33
		200	35	-36	10	-55	34	-35	11	-55
		150	38	-39	10	-67	28	-29	10	-67
		100	32	-33	8	-77	12	-13	9	-77
DARWIN 12 25'S 130 53'E 1411NM	BRUNEI	700	3	-4	6	8	2	-2	5	10
	04 57'N 114 56'E	500	4	-5	6	-6	4	-5	5	-6
		300	5	-6	7	-32	2	-3	7	-32
		200	9	-10	9	-55	1	-2	8	-55
		150	6	-7	11	-69	4	-4	10	-70
		100	7	-1	10	-79	5	-6	10	-81
DARWIN 12 25'S 130 53'E 1467NM	JAKARTA	700	6	-7	7	8.7	6	-7	7	9.1
	06 17'S 106 53'E	500	6	-7	8	-6.4	5	-6	7	-5.7
		300	6	-7	9	-32.2	2	-4	9	-30.9
		200	6	-7	10	-54.5	8	-9	11	-54.2
		100	7	-8	9	-79.0	10	-12	10	-80.2
DARWIN 12 25'S 130 53'E 1127NM	LEARMONTH	700	0	-1	9	8.0	4	5	9	8.2
	22 14'S 114 05'E	500	-10	8	12	-6.6	-7	6	11	-6.5
		300	-17	15	14	-32.3	-19	17	15	-32.0
		200	-17	16	16	-54.6	-21	19	16	-53.8
		100	-14	13	12	-78.2	-8	7	12	-79.2
DARWIN 12 25'S 130 53'E 1434NM	PERTH	700	-6	5	8	4	-6	5	8	6
	31 56'S 115 58'E	500	-18	15	12	-11	-14	11	10	-11
		300	-37	31	16	-36	-31	25	16	-36
		200	-42	34	17	-54	-35	28	16	-54
		150	-40	36	15	-64	-29	25	13	-65
		100	-38	34	13	-72	-17	16	9	32
DARWIN 12 25'S 130 53'E 982NM	PORT MORESY	700	-6	5	7	9	-5	4	6	9
	09 16'S 147 13'E	500	2	-3	8	-6	-5	5	7	-6
		300	12	-13	10	-32	12	-12	10	-32
		200	8	-8	11	-55	15	-15	11	-54
		150	19	-19	13	-68	12	-12	11	-68
		100	22	-23	11	-78	9	-10	12	-80
DARWIN 12 25'S 130 53'E 1004NM	TOWNSVILLE	700	1	-2	8	8	1	2	7	8
	19 15'S 146 46'E	500	13	-14	9	-7	7	-7	9	-7
		300	30	-32	13	-33	27	-28	12	-33
		200	32	-34	14	-55	32	-34	16	-54
		150	37	-38	14	-67	25	-26	14	-67
		100	37	-38	13	-76	11	-12	13	-77
DIEGO GARCIA 07 18'S 72 24'E 2568NM	LEARMONTH	700	-1	0	6	7.7	0	0	6	7.8
	22 14'S 114 05'E	500	9	-10	8	-6.6	0	-1	8	-6.4
		300	21	-22	10	-32.5	16	-18	10	32.7
		200	13	-14	11	-54.6	25	-26	11	-53.8
		100	1	-2	9	-77.4	0	0	8	-78.1

ROUTE			JUN - AUG				SEP - NOV			
A	B	HPA	O	H	SD	T	O	H	SD	T
DIEGO GARCIA 07 18'S 72 24'E 2843NM	PERTH 31 56'S 115 58'E	700	3	-4	7	4.5	3	-4	8	5.2
		500	18	-20	10	-10.1	13	-14	9	-9.1
		300	41	-44	14	-34.4	30	-32	13	-35.0
		200	42	-45	15	-53.6	38	-40	14	-53.5
		100	15	-17	10	-73.6	8	-10	10	-73.2
DIEGO GARCIA 07 18'S 72 24'E 1020NM	SEYCHELLES 04 40'S 55 31'E	700	6	-7	6	8.6	5	-6	7	8.4
		500	0	-1	8	-6.1	7	-8	7	-5.7
		300	4	-5	10	-31.1	5	-6	10	31.5
		200	7	-8	11	-54.3	-6	4	12	-54.2
		100	18	-19	10	-77.0	7	-9	11	-77.9
DIEGO GARCIA 07 18'S 72 24'E 1956NM	SINGAPORE 01 21'N 103 54'E	700	-1	0	5	8.6	-1	0	6	8.2
		500	-5	4	7	-6.5	-8	6	6	-6.1
		300	-10	9	8	-32.2	-7	6	8	-32.2
		200	-16	14	8	-54.8	-10	9	9	-53.9
		100	-27	26	8	-77.4	-26	25	9	-79.6
FIJI 17 45'S 177 27'E 2756NM	HONOLULU 21 21'N 157 56'W	700	-4	4	4	9	-4	4	4	10
		500	-2	1	5	-6	-2	2	6	-6
		300	3	-3	7	-33	0	-1	7	-32
		200	4	-6	10	-55	9	-11	9	-54
		150	1	-2	9	-68	11	-12	9	-68
100	-2	2	6	-77	4	-5	7	-77		
FIJI 17 45'S 177 27'E 2776NM	MIDWAY 28 15'N 177 22'W	700	-1	0	4	9	-1	1	4	10
		500	-2	1	5	-6	-1	1	5	-6
		300	0	-1	7	-35	-3	2	8	-32
		200	-1	0	10	-55	1	-2	10	-54
		150	0	-1	8	-67	1	-2	9	-68
100	-1	0	6	-76	-3	3	8	-76		
GUAM 13 54'N 144 55'E 1787NM	DARWIN 12 25'S 130 53'E	700	1	-2	5	9	2	-2	5	10
		500	3	-4	6	-5	4	-4	5	-5
		300	3	-3	6	-31	2	-2	6	-31
		200	0	0	9	-55	2	-2	8	-54
		150	3	-4	10	-69	1	-2	9	-69
100	0	-11	9	-79	5	-5	9	-80		
GUAM 13 54'N 144 55'E 2691NM	FIJI 17 45'S 177 27'E	700	-7	7	4	9	-4	4	3	10
		500	-4	3	5	-6	-4	4	4	-6
		300	2	-3	6	-32	0	-1	6	-32
		200	3	-4	9	-55	3	-3	8	-54
		150	3	-4	8	-69	4	-5	8	-69
100	3	-3	7	-78	0	-1	7	-79		
HICKHAM 21 20'N 157 55'W 2123NM	BUCHOLZ 08 43'N 167 44'E	700	12	-13	8	10.5	9	-10	8	10.0
		500	7	-8	10	-5.9	7	-8	9	-5.4
		300	-12	10	7	-32.2	1	-3	12	-32.4
		200	-19	18	9	-54.4	-18	17	12	-53.3
		100	4	5	8	-76.0	-2	0	13	-75.2

GEN 3.5

ROUTE		HPA	JUN - AUG				SEP - NOV			
A	B		O	H	SD	T	O	H	SD	T
HICKHAM 21 20'N 157 55'W 4058NM	TOWNSVILLE 19 15'S 146 46'E	700	3	-4	5	9.4	4	-5	5	9.3
		500	0	0	7	-6.1	1	-2	6	-5.7
		300	-9	8	7	2.0	-2	1	8	-32.0
		200	-12	10	8	-54.7	-15	14	9	-53.8
		100	-2	1	7	7.5	-2	1	8	-78.2
HONG KONG 22 19'N 114 12'E 1044NM	BRUNEI 04 56'N 114 56'E	700	-5	4	7	10	10	0	7	10
		500	-2	1	7	-4	-1	0	7	-5
		300	-1	0	7	-30	0	-1	9	-30
		200	-1	-1	9	-53	1	-2	10	-53
		150	0	-3	12	-67	1	-3	12	-66
100	2	6	11	-78	5	-6	9	-77		
HONG KONG 22 19'N 114 21'E 1270NM	KUCHING 01 29'N 110 20'E	700	-6	5	7	10	0	0	7	10
		500	-1	0	6	-5	0	-1	7	-5
		300	2	-3	6	-30	1	-2	8	-31
		200	5	-8	8	-54	4	-5	9	-54
		150	7	-10	11	-68	7	-10	11	-67
100	9	-13	10	-78	10	-11	9	-78		
HONIARA 09 25'S 160 02'E 1131NM	FIJI 17 45'S 177 27'E	700	-6	6	7	8	2	-2	5	8
		500	8	-8	9	-7	3	-4	8	-7
		300	18	-19	11	-33	17	-18	12	-33
		200	22	-23	14	-55	20	-21	14	-55
		150	18	-19	13	-68	19	-20	13	-67
100	13	-13	9	-76	10	-10	10	-77		
HONOLULU 21 21'N 157 56'W 2270NM	PAGO PAGO 14 20'S 170 43'W	700	3	-3	4	9	4	-4	4	10
		500	1	-2	6	6	2	-2	5	-5
		300	-2	1	7	-33	0	-1	8	-32
		200	-3	2	10	-55	-7	6	9	-54
		150	-1	0	8	-67	-8	7	10	-68
100	3	-4	6	-77	-3	2	7	-77		
HONOLULU 21 21'N 157 56'W 2080NM	SAN FRANCISCO 37 37'N 122 23'W	700	1	-1	6	8	1	-2	7	5
		500	-2	1	7	-8	12	-14	9	-11
		300	10	-12	11	-36	19	-21	14	-38
		200	16	-19	13	-54	24	-26	14	-55
		150	12	-13	9	-62	24	-26	13	-63
100	-5	4	6	-66	13	-15	9	-68		
JAKARTA 06 09'S 106 51'E 483NM	SINGAPORE 01 21'N 103 54'E	700	0	0	8	9	1	-1	6	9
		500	3	-4	9	-5	2	-2	7	-6
		300	5	-6	9	-31	4	-4	9	-32
		200	7	-9	11	-55	2	-2	11	-55
		150	8	-10	14	-69	4	-6	14	-70
100	8	-10	14	-79	4	-5	13	-81		

ROUTE			JUN - AUG				SEP - NOV				
A	B	HPA	O	H	SD	T	O	H	SD	T	
JOHNSTON 16 44'N 169 31'W	FIJI 17 45'S 177 27'E	700	2	-3	4	9	2	-3	4	10	
		500	2	-2	6	-6	2	-3	5	-6	
		300	-2	1	7	-32	-1	0	8	-32	
		2208NM	200	-3	2	10	-55	-6	5	10	-54
		150	-3	2	9	-68	-8	7	10	-69	
100	3	-3	6	-77	-2	1	8	-78			
JOHNSTON 16 44'N 169 31'W	MIDWAY 28 13'N 177 22'W	700	3	-3	6	8	2	-2	8	9	
		500	3	-3	8	-7	-4	3	10	-6	
		300	-7	6	13	-34	-9	7	16	-33	
		814NM	200	-11	9	18	-55	-13	12	18	-54
		150	-4	4	13	-64	-18	17	18	-64	
100	6	-6	8	-70	-9	9	13	-71			
KOTA KINABALU 05 56'N 116 03'E	KUCHING 01 29'N 110 20'E	700	-5	4	7	9.1	-5	4	8	9.0	
		500	6	-8	9	-6.1	5	-7	8	-5.9	
		300	14	-16	10	-31.8	7	-8	11	-31.4	
		434NM	200	22	-24	11	-54.3	21	-22	13	-54.2
		100	28	-30	11	-78.6	24	-25	13	-80.0	
KOTA KINABALU 05 56'N 116 03'E	MANILA 14 31'N 121 01'E	700	5	-6	9	10.5	-1	0	9	9.7	
		500	0	-1	11	-5.0	-3	1	10	-5.6	
		300	-8	6	10	-30.9	-5	3	13	-30.7	
		592NM	200	-13	11	12	-54.3	-15	13	14	-54.2
		100	-21	17	11	-78.9	-16	14	16	-78.9	
KOTA KINABALU 05 56'N 116 03'E	SINGAPORE 01 21'N 103 54'E	700	-5	4	6	9.1	-7	6	8	8.8	
		500	8	-9	9	-6.2	7	-8	8	-6.1	
		300	17	-19	10	-31.8	8	-9	10	-31.4	
		778NM	200	28	-29	10	-54.5	22	-23	12	-54.2
		100	36	-37	10	-78.5	29	-31	12	-80.9	
KUALA LUMPUR 03 08'N 101 33'E	BRUNEI 04 56'N 114 56'E	700	7	-7	7	9	7	-8	7	10	
		500	-10	9	7	-5	-8	7	7	-5	
		300	-20	20	7	-31	-11	11	8	-31	
		808NM	200	-38	38	10	-55	-7	7	10	-55
		150	-40	40	12	-69	-31	30	13	-69	
100	-43	42	13	-79	-34	33	11	-80			
KUALA LUMPUR 03 08'N 101 33'E	COLOMBO 06 54'N 79 52'E	700	-11	11	6	9	-7	6	6	9	
		500	2	-3	6	-5	8	-8	6	-5	
		300	18	-18	6	-31	11	-11	7	-32	
		1335NM	200	38	-39	8	-55	3	-4	9	-54
		150	47	-48	10	-68	32	-33	11	-69	
100	49	-50	11	-78	40	-41	10	-81			
KUALA LUMPUR 03 08'N 101 33'E	SINGAPORE 01 21'N 103 54'E	700	5	-6	9	9	4	-4	8	9	
		500	-9	9	9	-5	-6	6	8	-5	
		300	-17	17	9	-31	-10	10	9	-32	
		177NM	200	-30	29	12	-55	-10	9	12	-55
		150	-34	32	15	-69	-25	24	15	-69	
100	-35	34	16	-79	-27	25	14	-81			

ROUTE		HPA	JUN - AUG				SEP - NOV			
A	B		O	H	SD	T	O	H	SD	T
KUCHING 01 29'N 110 20'E 346NM	BRUNEI 04 56'N 114 56'E	700	4	-5	8	9	5	-6	8	10
		500	-8	8	8	-5	-6	5	7	-5
		300	-16	16	8	-51	-9	9	9	-31
		200	-29	28	11	-55	-9	9	11	-55
		150	-30	29	14	-69	-25	24	15	-70
100	-33	31	15	-79	-27	26	13	-80		
KUCHING 01 29'N 110 20'E 386NM	SINGAPORE 01 21'N 103 54'E	700	-5	-4	7	8.2	-6	5	8	8.5
		500	9	-10	9	-6.9	7	-8	8	-6.3
		300	21	-22	11	-32.4	9	-10	11	-31.7
		200	26	-27	11	-54.4	17	-18	12	-54.1
		100	36	-37	11	-78.1	30	-32	12	79.9
LEARMONTH 22 14'S 114 05'E 1045NM	JAKARTA 06 16'S 106 53'E	700	-3	2	9	7.7	-1	0	9	8.6
		500	-6	4	11	-6.6	-1	0	10	-6.3
		300	-7	6	13	-32.6	-9	7	14	-32.0
		200	-5	4	15	-54.7	-13	11	15	-53.9
		100	-3	2	12	-78.3	-4	3	11	-79.5
LEARMONTH 22 14'S 114 05'E 2071NM	SYDNEY 33 56'S 151 10'E	700	15	-16	10	-0.4	15	17	11	3.0
		500	30	-32	14	-15.5	28	-30	14	-13.3
		300	68	-71	22	-38.6	53	-56	20	-38.7
		200	77	-81	23	-53.0	64	-67	20	-53.1
		100	43	-45	13	-67.2	27	-29	12	-67.8
MADRAS 13 00'N 80 11'E 1407NM	KUALA LUMPUR 03 08'N 101 33'E	700	11	-11	6	10	-2	1	6	9
		500	-3	3	6	-5	-7	7	6	-5
		300	-18	17	6	-30	-11	10	7	-31
		200	-36	35	9	-54	-12	11	8	-54
		150	-47	46	10	-68	-29	28	10	-69
100	-48	47	10	-78	-36	35	9	-81		
MAURITIUS 20 26'S 57 40'E 2302NM	COCOS 12 11'S 96 50'E	700	-1	-1	5	6	-6	5	6	7
		500	5	-6	8	-7	3	-4	6	-8
		300	28	-30	10	-33	17	-19	10	-34
		200	29	-32	12	-52	21	-23	11	-54
		150	27	-28	11	-64	15	-15	9	-66
100	19	-20	9	-72	9	-10	7	-74		
MAURITIUS 20 26'S 57 40'E 3177NM	PERTH 31 56'S 115 58'E	700	11	-12	7	1	11	-12	7	2
		500	23	-29	9	-12	25	-27	8	-12
		300	49	-53	15	-38	41	-44	13	-39
		200	59	-62	15	-52	49	-51	14	-53
		150	55	-57	13	-59	46	-47	11	-61
100	40	-41	9	-64	19	-30	8	-66		
MIDWAY 28 13'N 177 22'W 1134NM	HONOLULU 21 21'N 157 56'W	700	-3	3	6	8	-3	2	8	8
		500	-7	6	7	-7	7	-8	9	-7
		300	9	-10	12	-34	10	-10	15	-35
		200	18	-19	17	-55	20	-20	17	-54
		150	9	-10	12	-65	20	-20	17	-64
100	-8	8	7	-68	10	-10	11	-70		

ROUTE		HPA	JUN - AUG				SEP - NOV			
A	B		O	H	SD	T	O	H	SD	T
NADI 17 45'S 177 26'E 1710NM	SYDNEY 33 56'S 151 10'E	700	-15	13	11	-0.1	-12	10	12	2.7
		500	-30	26	15	-15.6	-26	23	14	-13.1
		300	-63	54	24	-52.9	-46	41	22	-53.2
		200	-72	63	24	-52.9	-46	41	22	-53.2
		100	-38	35	14	-66.2	-26	23	13	-65.9
PAGO PAGO 14 20'S 170 43'W 439NM	FIJI 17 45'S 177 27'E	700	1	-2	8	8	-4	4	7	8
		500	-15	14	11	-8	-11	11	9	-8
		300	-25	24	15	-34	-27	26	15	-34
		200	-32	31	17	-55	-33	32	18	-55
		150	-30	29	15	-68	-33	32	15	-67
		100	-14	13	10	-74	-16	16	11	-74
PERTH 31 56'S 115 58'E 2046NM	BRISBANE 27 25'S 155 05'E	700	12	-14	9	2	16	-18	9	1
		500	31	-21	10	-14	36	-37	12	-16
		300	58	-61	20	-42	55	-58	17	-41
		200	73	-76	21	-53	63	-66	18	-53
		150	67	-69	18	-59	55	-57	16	-60
		100	39	-40	12	-63	34	-35	12	-64
PERTH 31 56'S 115 58'E 3756NM	SEYCHELLES 04 40'S 55 31'E	700	-7	6	5	4	-4	3	5	5
		500	-14	12	7	-10	-14	13	6	-10
		300	-36	33	11	-35	-28	26	10	-36
		200	-38	36	11	-52	-34	32	10	-53
		150	-37	35	10	-62	-29	28	9	-64
		100	-24	23	8	-70	-17	16	6	-71
PERTH 31 56'S 115 58'E 2111NM	SINGAPORE 01 21'N 103 54'E	700	-1	0	7	6	-2	1	7	7
		500	-4	2	8	-9	-4	2	7	-9
		300	-12	5	12	-34	-11	7	12	-34
		200	-12	6	13	-54	-12	8	12	-54
		150	-10	5	12	-66	-8	4	12	-67
		100	-5	1	70	-75	-3	1	9	-75
PERTH 31 56'S 115 58'E 1768NM	SYDNEY 33 56'S 151 10'E	700	18	-19	12	-4.1	19	-20	13	-0.2
		500	30	-32	16	-20.3	30	-31	16	-16.6
		300	63	-65	24	-43.6	52	-54	23	-42.2
		200	83	-86	26	-52.2	61	-63	23	-52.8
		100	45	-47	13	-61.3	28	-30	12	-61.5
PERTH 31 56'S 115 58'E 1823NM	TOWNSVILLE 19 15'S 146 46'E	700	10	-11	8	2	11	-12	8	4
		500	29	-31	11	-14	28	-29	11	-13
		300	59	-64	18	-38	51	-55	16	-38
		200	70	-74	19	-54	61	-64	18	-53
		150	66	-69	16	-62	52	-54	16	-63
		100	44	-46	13	-69	30	-31	12	-68
PERTH 31 56'S 115 58'E 1066NM	WOOMERA 31 09'S 136 49'E	700	21	-22	13	2.3	21	-23	14	1.6
		500	39	-40	18	-17.7	33	-34	18	-14.8
		300	82	-84	30	-40.2	62	-64	25	-40.1
		200	107	-109	31	-52.3	76	78	26	-53.1
		100	51	-52	17	-65.2	34	-35	16	-65.3

ROUTE		HPA	JUN - AUG				SEP - NOV			
A	B		O	H	SD	T	O	H	SD	T
PORT MORESBY 09 26'S 147 13'E 1387NM	GUAM 13 34'N 144 55'E	700	2	-3	5	10	2	-3	5	10
		500	1	-1	6	-5	1	-1	5	-5
		300	0	-1	7	-31	1	-1	7	-31
		200	2	-2	10	-55	-1	1	9	-54
		150	0	-1	11	-69	2	-2	10	-69
100	-6	5	9	-79	-1	1	9	-80		
PORT MORESBY 09 26'S 147 13'E 759NM	HONIARA 09 25'S 160 02'E	700	-8	8	6	9	-6	6	5	9
		500	-1	1	8	6	-8	8	7	-6
		300	7	-7	8	-32	7	-7	10	-32
		200	7	-7	13	-55	9	-10	11	-55
		150	2	-3	14	-69	8	-8	11	-68
100	12	-13	11	-79	9	-9	12	-80		
PORT MORESBY 09 26'S 147 13'E 2663NM	SINGAPORE 01 21'N 103 54'E	700	5	-5	4	9	2	-3	3	10
		500	7	-7	4	-6	6	-7	4	-6
		300	9	-9	6	-32	5	-6	5	-32
		200	14	-14	7	-55	4	-4	6	-55
		150	11	-12	8	-69	7	-8	7	-70
100	12	-13	8	-79	9	-10	8	-81		
SEYCHELLES 04 40'S 55 31'E 1615NM	COLOMBO 06 54'N 79 52'E	700	7	-7	4	9	-2	2	4	9
		500	0	0	5	-5	-8	8	5	-6
		300	-10	9	7	-31	-8	7	6	-32
		200	-20	20	9	-54	8	-8	7	-54
		150	-25	23	10	-66	-8	7	9	-68
100	-26	25	10	-77	-23	22	8	-80		
SEYCHELLES 04 40'S 55 31'E 2908NM	SINGAPORE 01 21'N 103 54'E	700	5	-5	4	9	0	-1	4	9
		500	-6	6	4	-5	-8	8	4	-6
		300	-11	10	5	-31	-10	9	5	-32
		200	-20	19	7	-55	-3	2	6	-54
		150	-21	21	8	-67	-19	18	7	-69
100	-24	24	8	-77	-27	26	7	-79		
SINGAPORE 01 21'N 103 54'E 770NM	BANGKOK 13 44'N 100 30'E	700	-1	0	7	10	1	-2	8	9
		500	6	-7	7	-5	2	-3	7	-5
		300	5	-6	7	-30	3	-4	9	-31
		200	8	-12	10	-54	1	-4	10	-55
		150	12	-17	12	-68	4	-7	13	-68
100	8	-19	13	-79	0	-7	11	-80		
SINGAPORE 01 21'N 103 54'E 690NM	BRUNEI 04 56'N 114 56'E	700	5	-6	8	9	7	-7	7	10
		500	-10	9	7	-5	-7	7	7	-5
		300	-19	19	7	-31	-11	10	8	-31
		200	-35	35	10	-55	-10	10	10	-55
		150	-37	36	13	-69	-29	29	13	-69
100	-39	38	13	-79	-32	31	12	-80		

ROUTE		HPA	JUN - AUG				SEP - NOV			
A	B		O	H	SD	T	O	H	SD	T
SINGAPORE 01 21'N 103 54'E	CLARK 15 10'N 120 34'E	700	7	-8	6	10	1	-1	7	10
		500	-6	5	6	-5	-6	6	6	-5
		300	-14	14	6	-31	-9	9	7	-31
		200	27	25	8	-54	-11	10	9	-55
		150	-31	30	11	-69	-24	22	11	-68
1285NM	100	-36	34	11	-79	-27	26	9	-80	
SINGAPORE 01 21'N 103 54'E	COCOS 12 11'S 96 50'E	700	-1	1	7	8	1	-1	7	9
		500	2	-3	8	-6	3	-4	6	-6
		300	2	-3	8	-32	2	-3	9	-32
		200	4	-6	12	-55	1	-2	10	-55
		150	6	-7	13	-69	8	-10	12	-69
915NM	100	3	-6	12	-78	9	-11	11	-80	
SINGAPORE 01 21'N 103 54'E	DARWIN 12 26'S 130 52'E	700	-1	1	5	9	-3	3	5	9
		500	-5	5	7	-6	-6	6	5	-6
		300	-5	4	7	-32	-5	4	7	-32
		200	-11	9	10	-55	-1	0	7	-55
		150	-15	14	10	-69	-5	5	9	-70
1803NM	100	-7	5	9	-79	-8	7	9	-80	
SINGAPORE 01 21'N 103 54'E	HONG KONG 22 19'N 114 12'E	700	7	-7	6	10	-1	0	6	9
		500	0	0	6	-5	-2	2	6	-5
		300	-7	6	6	-30	-3	2	8	-31
		200	-16	14	8	-54	-7	7	9	-54
		150	-19	16	10	-67	-10	8	10	-67
1391NM	100	-23	19	10	-78	-17	15	9	-78	
SINGAPORE 01 21'N 103 54'E	SYDNEY 33 56'S 151 10'E	700	2	-4	7	4.0	2	-4	7	5.9
		500	6	-8	9	-11.0	7	-8	8	-9.6
		300	17	-21	13	-35.3	16	-19	12	-34.9
		200	21	-25	14	-53.8	19	-21	13	-53.6
		150	-19	16	10	-67	-10	8	10	-67
3396NM	100	-23	19	10	-78	-17	15	9	-78	
SYDNEY 33 56'S 151 10'E	AUCKLAND 37 01'S 174 47'E	700	13	-15	14	-5.3	10	-12	15	-1.5
		500	21	-23	19	-22.3	23	-25	20	-17.9
		300	45	-47	27	-46.7	36	-38	27	-44.2
		200	64	-67	29	-51.9	36	-38	27	-52.6
		150	41	-42	14	-57.8	19	-20	13	-58.4
1166NM	100	41	-42	14	-57.8	19	-20	13	-58.4	
SYDNEY 33 56'S 151 10'E	DARWIN 12 25'S 130 53'E	700	-6	4	10	2.3	-3	2	10	4.3
		500	-19	16	14	-13.0	-17	14	13	-11.2
		300	-43	37	20	-36.7	-34	30	18	-36.6
		200	-51	46	21	-53.3	-39	35	19	-53.3
		150	-31	29	13	-70.0	-17	15	12	-71.1
1701NM	100	-31	29	13	-70.0	-17	15	12	-71.1	
SYDNEY 33 56'S 151 10'E	TOWNSVILLE 19 15'S 146 46'E	700	0	-3	13	-0.5	-1	0	14	2.6
		500	-8	2	18	-15.9	-8	3	17	-13.3
		300	-25	7	28	-38.7	-18	7	24	-38.8
		200	-29	9	29	-52.9	-21	8	25	-53.1
		150	-16	11	17	-66.5	-10	7	16	-67.3
912NM	100	-16	11	17	-66.5	-10	7	16	-67.3	

GEN 3.5

ROUTE			JUN - AUG				SEP - NOV			
A	B	HPA	O	H	SD	T	O	H	SD	T
TOWNSVILLE 19 15'S 146 46'E 1229NM	BAUERFILED 17 42'S 168 19'E	700	5	-6	7	7	6	-7	7	7
		500	23	-23	10	-8	15	-16	9	-9
		300	49	-50	14	-34	41	-42	14	-34
		200	52	-53	14	-55	51	-53	17	-55
		150	52	-52	14	-67	43	-44	14	-66
100	33	-33	11	-75	19	-20	11	-75		
TOWNSVILLE 19 15'S 146 46'E 970NM	HONIARA 09 25'S 160 02'E	700	-1	0	7	8	2	-2	6	8
		500	8	-9	9	-7	4	-5	9	-7
		300	20	-22	12	-33	18	-20	12	-32
		200	25	-26	14	-55	24	-26	15	-55
		150	22	-23	14	-68	21	-22	13	-67
100	21	-23	11	-77	11	-11	12	-78		
TOWNSVILLE 19 15'S 146 46'E 590NM	PORT MORESBY 09 26'S 147 13'E	700	0	-1	8	8	0	-1	7	8
		500	0	-1	9-	7	0	-1	10	-7
		300	0	-3	14	-33	0	-3	13	-32
		200	1	-4	15	-55	2	-5	16	-55
		150	1	-4	15	-68	3	-4	14	-67
100	-1	-1	13	-77	2	-3	14	-78		
WILLIAMTOWN 32 48'S 151 50'E 1088NM	ALICE SPRINGS 23 49'S 133 54'E	700	-14	12	13	-2.4	-15	13	14	1.6
		500	-28	25	18	-18.0	-26	24	17	-15.0
		300	-67	60	28	-40.6	-51	46	25	-40.4
		200	-82	74	29	-52.5	-61	56	26	-53.0
		100	-45	43	16	-63.6	-26	24	15	-64.8
WILLIAMTOWN 32 48'S 151 50'E 392NM	EAST SALE 38 06'S 147 09'E	700	-11	9	17	-6.7	-11	8	18	-3.1
		500	-14	11	23	-23.7	-17	13	23	-19.4
		300	-26	20	31	-48.7	-24	19	31	-45.1
		200	-33	26	31	-52.9	-27	22	31	-52.5
		100	-23	20	16	-56.0	-14	11	15	-56.1
WILLIAMTOWN 32 48'S 151 50'E 669NM	EDINBURGH 34 42'S 138 37'E	700	-17	15	15	-5.8	-18	16	17	-1.6
		500	-24	23	20	-22.6	-30	28	22	-18.2
		300	-52	50	29	-46.6	-46	44	29	-44.1
		200	-70	68	32	-52.1	-52	50	29	-52.6
		100	-44	42	15	-57.6	-24	23	14	-58.3
WILLIAMTOWN 32 48'S 151 50'E 982NM	MOUNT ISA 20 40'S 139 29'E	700	-8	6	13	-0.5	-8	6	13	2.7
		500	-23	19	17	-15.9	-20	17	17	-13.3
		300	-56	45	27	-38.6	-43	35	24	-38.8
		200	-66	54	28	-52.9	-51	43	25	-53.1
		100	-38	34	16	-66	-23	21	15	-67.4
WILLIAMTOWN 32 48'S 151 50'E 770NM	WOOMERA 31 09'S 136 49'E	700	-17	15	14	-4.4	-19	17	16	-0.1
		500	-29	27	19	-20.7	-31	29	20	-16.8
		300	-66	63	30	-43.8	-53	51	27	-42.5
		200	-85	82	32	-52.2	-62	59	28	-52.8
		100	-47	46	16	-60.2	-27	26	15	-61.2



GEN 3.6 SEARCH AND RESCUE

1. PURPOSE

1.1 The purpose of the Search and Rescue (SAR) organisation is to provide assistance to aircraft in distress and to search for, provide aid to, and organise the rescue of survivors of aircraft accidents and forced landings.

2. RESPONSIBLE AUTHORITIES

2.1 Airservices Australia is responsible for the provision of a SAR alerting and in-flight emergency response service. Joint Rescue Coordination Centre (JRCC) Australia is responsible for the conduct of SAR for missing civil aircraft, civil aircraft reported crashed and ELT searches within the Search and Rescue Region (SRR) under Australian jurisdiction.

2.2 **ADF** - CJOPS is responsible for the direction and execution of all SAR operations. The Headquarters Joint Operations Command (HQJOC) Air and Space Operations Centre (AOC) Joint Personnel Recovery Officer (JPRO) represents CJOPS for coordination and tasking of ADF assets with all SAR agencies under the authority of a CJOPS appointed SAR Commander.

2.2.1 RAN is responsible for the provision of SAR in respect of ADF and visiting naval ships, submarines and ship-borne aircraft. This responsibility is exercised by HQJOC.

2.2.2 ARMY is responsible for the provision of SAR in respect of ADF and foreign military personnel in a land environment. This responsibility is exercised by HQJOC.

2.2.3 RAAF is responsible for SAR for all other ADF and visiting military aircraft. This responsibility is exercised by HQJOC.

3. ORGANISATION

3.1 The Australian Maritime Safety Authority (AMSA) have established a Joint Rescue Coordination Centre in Canberra (JRCC AUSTRALIA) which is responsible for the coordination of aviation and maritime SAR efforts within the Australian SRR. Refer to the chart at para 10.

3.2 **ADF** - In the event of a SAR for military aircraft or vessels, HQJOC will coordinate the SAR. Initial notification is to be through the HQJOC Joint Coordination Centre Watchkeeper (JCC WK).

4. ADF - RESCUE COORDINATION CENTRES

a. **ADF Urgent SAR Contact:**

Joint Coordination Centre - Watchkeeper

☎ +61 2 6128 4333

FAX: +61 2 6128 4307

Message: HQJOC

Email: hqjoccc.ops@defence.gov.au

b. **ADF Administrative SAR Requirements:**

SO2 Joint Personnel Recovery 1

HQJOC Air and Space Operations Centre

PO Box 7928

CANBERRA, ACT 2610

☎ +61 2 6128 4850

FAX: +61 2 6128 5175

Message: HQJOC AOC-OPS

c. **Australia RCC:**

JRCC Australia

82 Northbourne Avenue

BRADDON, ACT 2601

Postal Address:

GPO Box 2181

CANBERRA CITY, ACT 2601

☎ +61 1800 815 257

+61 2 6230 6899 (overseas)

+61 419 309 721 (text message)

FAX: +61 1800 622 153

Email: rccaus@amsa.gov.au

Website: www.amsa.gov.au/safety-navigation/search-and-rescue

AFTN: YSARYCYX

5. EMERGENCY ALERTING PROCEDURES

5.1 Pilot Notification

5.1.1 The efficacy of the SAR action by Airservices or JRCC Australia is directly related to the amount and accuracy of details notified in the flight notification or flight note, and to any position details reported in flight. When notifying of in-flight difficulties, early advice and the degree of apprehension felt by the pilot will enhance the assistance which can be provided by the ground organisation.

5.1.2 When a pilot lands at a place other than an aerodrome included in the flight notification, the pilot should report the fact to ATS, JRCC Australia or the Police as soon as possible.

5.1.3 **Flight Notes.** Persons maintaining a SARWATCH by means of a Flight Note must contact JRCC Australia in the event that the flight becomes overdue.

5.2 Advice to Aircraft Operators

5.2.1 If an emergency phase is declared, where practicable, the aircraft operator will be advised as follows:

- a. **Uncertainty or Alert phase** - the ATS unit will advise the operator of all relevant information passed to JRCC Australia; or
- b. **Distress phase** - JRCC Australia will advise the operator of all SAR response actions.

5.3 In-Flight Emergency Response Action

5.3.1 **Radio Failure or Failure to Report.** On the basis that only the aircraft's transmitter may have failed and that ground transmissions can still be received, the following information may be broadcast from suitable stations, including some radio navigation aids:

- a. lowest safe altitudes;
- b. direction, bearings, DR position or headings to steer if practicable;
- c. emergency aerodromes;
- d. weather conditions at destination and alternates;
- e. ditching weather report; and
- f. separation action being taken by ATC.

5.3.2 **Navigational Assistance.** All available navigation aids, which may be of use to the aircraft, will be switched on and non-continuous aids may also be activated. Furthermore:

- a. ATS surveillance system equipped units will keep a lookout for the aircraft;
- b. aerodrome lighting may be activated; and
- c. if the aircraft can advise its last known position, and headings, speed and times flown since that position, an air plot can be made, actual winds added and a DR position and heading to steer passed to the aircraft on an advisory basis.

5.3.3 **Intercept and Escort.** Arrangements may be made to escort an aircraft experiencing abnormal operations.

5.3.4 **Ditching.** When a ditching is likely, the JRCC will obtain the positions of ships along the aircraft's route and advise the pilot, and:

- a. attempts will be made to arrange a direct speech link or a rapid relay system between the aircraft and a selected ship;
- b. weather reports, including sea conditions and a selected ditching heading will be passed to the aircraft; and
- c. arrangements may be made for ships to provide navigational assistance, lighting, and reduce the effects of the sea, swell or wind.

5.4 Medical Emergency

5.4.1 A pilot that is not engaged in the transport of patients under HOSP or MEDEVAC operations, should notify ATC of an on board medical emergency by declaring a PAN and appending the words 'MEDICAL PRIORITY REQUIRED'. The pilot should specify any service attendance requirements such as RFFS. ATC will provide the flight with MEDEVAC priority but will not arrange an ambulance or activate aerodrome emergency procedures unless requested. Declaring a medical emergency does not satisfy the biosecurity pre-reporting requirements specified in GEN 1.3.

5.4.2 The pilot of a medical flight should notify ATC of changes to priority requirements by changing the status of their flight e.g. by amending status from HOSP to MEDEVAC.

5.5 Participation In Searches

5.5.1 **ADF - General.** When requested by JRCC Australia to carry out a SAR operation, the aircraft and crew are deemed to be hired by JRCC Australia. ADF aircraft captains may elect to assist under the provisions of DACC Category 1.

5.5.2 **Briefing.** Whenever possible the pilot of a search aircraft should contact the JRCC to confirm the briefing prior to the search commencing.

5.5.3 **Debriefing.** Pilots should present a post-flight report to the JRCC as soon as possible after completion of the flight.

5.5.4 **Safety.** Civil aircraft engaged in SAR operations are required to comply with the Civil Aviation Regulations and Civil Aviation Safety Regulations.

6. EMERGENCY LOCATOR TRANSMITTER (ELT)

6.1 Procedures detailing the use of ELTs in an emergency are found in ERSA EMERG.

Note 1: While the installation and use of automatic ELTs saves lives, improper use will lead to false alarms and a resultant strain on scarce SAR resources.

Note 2: An ELT with GPS is able to transmit an accurate GPS location during an emergency. Search and rescue authorities will be able to locate the aircraft much faster if the ELT has GPS.

6.2 **Monitoring 121.5 MHz.** Distress beacons, including ELTs, transmit on 121.5, 243 and 406MHz. Pilots are requested to monitor 121.5MHz before engine start and after shutdown. Reception of a distress beacon transmission at any time is requested to be reported to ATS or the JRCC immediately.

6.3 **Inadvertent Activations.** If an ELT has been inadvertently activated, this must also be reported to ATS or JRCC Australia immediately.

6.4 **Testing ELTs.** Operational tests must be limited to 5 seconds, and the preferred procedure is that they be conducted within the first 5 minutes of the hour. JRCC Australia must be notified in advance of the test and, where the beacon is operated on 406 MHz, its HexID must be provided. Detailed ELT testing procedures can be found on the AMSA website at www.amsa.gov.au/beacons

6.5 **ELT Registration.** All ELTs must be registered on the Australian Beacon Register. See www.amsa.gov.au/beacons for further details.

Registration allows the JRCC Australia to respond more quickly and effectively to real distress activations of an ELT, and also helps the JRCC Australia respond appropriately to inadvertent activations.

7. COSPAS-SARSAT

7.1 COSPAS (from the Russian acronym for "Space System for Search of Vessels in Distress") and SARSAT (from "Search and Rescue Satellite Aided Tracking") is an international distress beacon detection system. The system has the capability to detect and provide locations for Emergency Locator Transmitters (ELTs), Personal Locator Beacons (PLBs) and Emergency Position Indicating Radio Beacons (EPIRBs).

The Australian Mission Control Centre (AUMCC) operated by the JRCC Australia in Canberra receives beacon data from satellite tracking stations in Australia and New Zealand, and from other Mission Control Centres (MCCs) around the world.

The COSPAS-SARSAT system detects and locates 406MHz ELTs, PLBs and EPIRBs all over the world. The system uses three satellite constellations to provide continuous, global coverage.

COSPAS-SARSAT compatible beacons also transmit a local homing signal on 121.5MHz. Some defence force beacons transmit an additional homing signal on 243MHz.

8. SEARCH AND RESCUE TRANSPONDER (SART)

8.1 The International Maritime Organisation has introduced a requirement for all vessels over 300 tonnes gross weight, engaged in international trade, to be equipped with SARTs. These devices are intended to enhance the probability of location and rescue of survivors.

8.2 SARTs work by responding to RADAR transmissions in the 9 Gigahertz (GHZ) range, the frequencies used by most maritime and aviation navigation and weather RADARs (aircraft RADARs would need to be used in the mapping mode).

8.3 When a SART receives a RADAR pulse, it will transmit 10 - 20 pulses in reply. This will show on the RADAR screen as a series of "returns" leading the way from the SART's position. SART transmissions will not interfere with the primary role of aircraft RADARs, i.e. weather detection.

8.4 ICAO and Airservices Australia do not intend to introduce SARTs to the aviation industry. However, pilots who detect SART transmissions should report them, with the position, to ATS, who will alert SAR authorities.

8.5 Example of SART 40° left at 19NM.

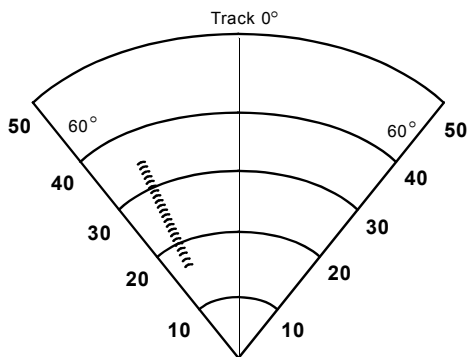

9. SAR ACTION

9.1 Events that will initiate SAR action include, but are not limited to: failure to cancel SARTIME, failure to cancel SARWATCH, aircraft declared overdue by Flight Note or concern from ATS, company, family or friends, an ELT activation, or other electronic distress notification device. As such, following safe arrival at destination, pilots are strongly encouraged to notify whomever is holding their SARWATCH as soon as practical after landing to avoid unnecessary SAR action.

10. SRR BOUNDARY

Australian SRR

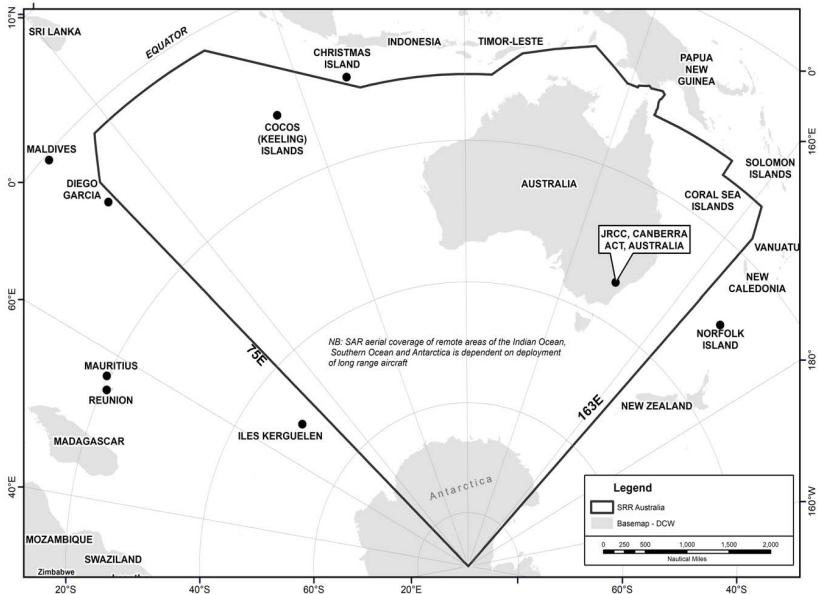

11. ADF - SAR AGREEMENTS

11.1 Provision for Entry of Foreign Aircraft

11.1.1 The following provisions cover the entry into and departure from Australian territory of foreign aircraft engaged in SAR operations.

11.2 Foreign Civil Aircraft

11.2.1 Foreign civil aircraft with the nationality of a Contracting State of ICAO may enter Australian territory for SAR operations upon ATC notification only.

11.3 Foreign State Aircraft

11.3.1 Under CASR 91.975, foreign State aircraft may not fly over or land in Australian territory except with the express permission of CASA.

11.3.2 As delays in obtaining approval could seriously compromise the success of a search, the SAR Mission Coordinator (SMC) may anticipate approval for the immediate entry of foreign State aircraft of contracting States of ICAO engaged in SAR, in such cases where the emergency nature of the operation justifies such action.

11.3.3 If a foreign State aircraft intends to fly over or land in Australian territory the SMC shall consult with HQJOC AOC (in the case of military aircraft) and obtain the permission/invitation of the Authorised Delegate, Head Office. The delegate will advise the SMC of any conditions pertaining to the permission/invitation, including security arrangements. The SMC will pass the approval and any conditions to the requesting authorities. For further information or to request approval for a foreign state aircraft to conduct operations in Australian territory, contact the AOC Diplomatic Clearance Administration section (DIPA): dipa.hqac@defence.gov.au or 02 6128 4819.

11.4 Aircraft of Non-Contracting States

11.4.1 When either civil or state aircraft of a non-contracting state are to be used for SAR operations, the approval of the Minister for Infrastructure and Transport is required for any operations over Australian territory. In giving their approval the Minister may specify conditions to be met by the operator.

11.4.2 In the case of foreign State aircraft of non-contracting states, the Minister's approval should also include instructions regarding security measures.

11.5 Airports

11.5.1 In the case of all foreign aircraft operating into Australian territory on SAR operations, both entry into and departure from Australian territory should, if practicable, be made at an international airport. As much notice as possible should be given to the local customs, immigration and biosecurity authorities to facilitate clearance procedure.

11.5.2 When the use of international airports for entry into and departure from Australian territory is not practicable, due to the nature of the SAR operation, the use of other airports may be approved subject to the following conditions:

- a. CIQ authorities are notified as soon as possible so that, if practicable, clearance formalities may be arranged.
- b. In the case of foreign military aircraft of Contracting States of ICAO, the senior RAAF Officer in the area is advised and consulted regarding any security arrangements which may be necessary.
- c. The aircraft crews, whether State or civil, are kept under surveillance of the officer-in-charge with respect to CIQ requirements, as well as from the viewpoint of security requirements in the case of military aircraft, until instructions are received from Head Office, or until the departure of the aircraft.

12. ADF - ADF SAR ORGANISATION

12.1 Unit Responsibilities

12.1.1 CJOPS is responsible for the direction and execution of all SAR operations. The Headquarters Joint Operations Command (HQJOC) Air and Space Operations Centre (AOC) Joint Personnel Recovery Officer (JPRO) represents CJOPS for coordination and tasking of ADF assets with all SAR agencies under the authority of a CJOPS appointed SAR Commander.

12.1.2 RAAF is responsible for SAR for all military and visiting foreign military aircraft except ship-borne aircraft in the Australian SRR. This responsibility is exercised for HQAC through HQJOC AOC JPRO.

12.1.3 Airbase Executive Officers (ABXO) are responsible for appointing an officer to be the Base Search and Rescue Officer (BSARO), and provide provisions for coordination of military aircraft SAR operations within a 50NM radius of their respective bases. To fulfil this requirement dedicated SAR resources are required for RAAF Bases Amberley, East Sale, Edinburgh, Pearce, Richmond, Tindal and Townsville. Local SAR reaction outside of 50NM is at the discretion of the BSARO and BSAROs should seek assistance from the HQJOC AOC JPRO. The type of support and level of coordination provided will be determined by the resources available at each base. In all cases the HQJOC AOC JPRO is to be notified immediately, through the AOC Watchkeeper, when a SAR operation is initiated.

12.1.4 If the BSARO determines that the provision of extra resources are required or coordination of the mission is beyond local capabilities the HQJOC AOC JPRO will assume SAR Mission Coordinator (SMC) responsibility for the operation and retain SMC authority of SAR operations until they are completed. In this situation the BSARO will act as a forward SAR controller and assist the HQJOC AOC JPRO as required.

12.1.5 Base Search and Rescue Officers (BSARO) at RAAF bases are responsible for:

- a. primary coordination of land, sea and air SAR operations within 50NM of their bases;
- b. keeping HQJOC AOC JPRO informed of the progress of all base SAR matters;
- c. ensuring appropriate base personnel are trained in SAR procedures and techniques;
- d. developing local SAR communication plans;
- e. informing the HQJOC AOC JPRO of relevant telephone numbers for SAR personnel, including those who may be deployed;
- f. ensuring that adequate SAR and communications equipment is stocked, stored and maintained correctly and submitting reports on SAR operations to the HQJOC AOC JPRO; and
- g. ensuring that the SAR helicopter is managed (where applicable) in accordance with AC SI(OPS) 04-16 *Contract Management – SAR Helicopter Support to RAAF Bases*.

12.2 Callsigns

12.2.1 ADF aircraft tasked for SAR will be assigned a "Rescue" callsign with a numerical suffix, allocated according to the origin of the aircraft as follows:

- a. JTF/CTF Force Assigned RAAF Aircraft 101-110
- b. AFTW 111-120
- c. 82WG 141-150
- d. 81WG 151-160
- e. 86WG 161-200
- f. 42WG 201-210
- g. 84WG 211-230
- h. CFS 231-240
- i. ARDU 241-250
- j. 92WG 251-270
- k. 2FTS 271-280
- l. Reserved 281-300

12.2.2 When multiple SAR aircraft are required for a major search, tasking authorities are to coordinate with RCC Australia or the AOC WK ((02) 6128 4810) to avoid duplicate callsigns.

12.3 Publicity

12.3.1 To minimise distress to relatives and others associated with SAR incidents, and to reflect the professionalism and competence of the ADF; release of appropriate information to the media must be properly controlled by the local Public Affairs Officer.

12.4 Distress Frequencies

12.4.1 International and regional distress frequencies used in the Australian SRR include:

- a. 2182 KHz - International distress (AM)
- b. 2524 KHz - Pleasure boat safety
- c. 3023 KHz - Scene of Action SAR (AM)
- d. 4125 KHz - Distress for small craft
- e. 5680 KHz - International distress
- f. 5696 KHz - Military aeronautical distress
- g. 27.88 MHz - Marine HF Distress
- h. 121.5 MHz - International aeronautical distress
- i. 123.1 MHz - SAR Scene of Action
- j. 123.2 MHz - Secondary Scene of Action
- k. 156.8 MHz - International Distress (Marine)
- l. 243.0 MHz - International Military Distress
- m. 282.8 MHz - Joint Scene of action common

12.5 Civilian SAR

12.5.1 Normally, liaison between Air Command Bases and civilian SAR authorities is to be directed through the HQJOC AOC JPRO. However, local Service Commanders may action requests for localised immediate assistance from any source (DACC). If a local commander does not consider that urgent action is necessary, or if they are unable to provide effective assistance, the request is to be referred to the appropriate SAR authority or the HQJOC AOC JPRO. In this context the captain of an ADF aircraft away from base is considered a local commander.

12.5.2 SAR equipped aircraft on stand-by may be used for DACC Category 1 and 2 tasks. When practicable, RAAF assistance, particularly for long range oceanic searches, will be provided to other SAR authorities, in particular:

- a. RCC Australia,
- b. Police Operation Centres, and
- c. Foreign RCCs.

12.6 Communications

12.6.1 Agreed forms of distress and SAR communications procedures are contained in FLIP, MATS and the NATSARMAN.

12.6.2 The operating wing or FEG will normally task the aircraft on request from HQJOC AOC. The SAR briefing will be provided by the RCC controlling the SAR operation. In the case of DACC, this will normally be provided by RCC Australia.

12.7 Reports

12.7.1 The following reports are to be passed by ADF aircraft involved in SAR actions:

- a. In-flight. On scene reports are required via SAR nets, or if the information is of an urgent nature; e.g., sighting reports; via phone patch to the appropriate RCC.
- b. Post-flight. Telephone reports to the RCC advising all pertinent details such as areas covered, degree of coverage and weather are required after landing.
- c. Post-mission. Post-mission reports (e.g. Purple) are to be submitted after each flight with at least "PRIORITY" precedence.
- d. Costing message. A Costing Message is to be completed for all SAR Operations other than those for the ADF, within seven days of completion of task.

12.7.2 For missions in support of RCC Australia, post-mission reporting is to include "RCC AUSTRALIA" as an addressee, with "PRIORITY" precedence. If survivors or wreckage are found and photographs taken, the RCC is to be provided with copies.

12.8 Conditions of Availability

12.8.1 The ADF has no units dedicated for civil SAR. There are, however, several assets throughout Australia which are dedicated to military SAR. When ADF assets are required in civil SAR, RCC Australia will contact HQJOC who will then coordinate the response on behalf of CJOPS with the assistance of the HQJOC AOC JPRO.

12.8.2 Naval units are all capable of rendering SAR assistance to some degree. Naval vessels are very manoeuvrable, fitted with sophisticated RADAR and communications equipment and carry liferafts and medical facilities on board.

12.8.3 RAAF maintains aircraft on military SAR standby around the country. These aircraft include C130 and AP-3C. C130 and AP-3C aircraft in particular are very capable long-range platforms, while they all may carry various types of air-droppable SAR stores. Chartered S76 SAR helicopters are based at RAAF Bases Amberley (QLD), East Sale (VIC), Pearce (WA), Tindal (NT) and Williamtown (NSW).

12.8.4 Army has no dedicated SAR units, however they do have helicopters and fixed wing aircraft which can provide assistance, subject to other commitments. Army helicopters do not normally carry droppable equipment, but may be fitted with a hoist and other associated rescue equipment.

12.8.5 RAN helicopters are based at NAS Nowra, may be deployed on shore around the country, and are carried on board many of the larger vessels. RAN helicopters do not normally carry droppable equipment, but may be fitted with a hoist and other associated rescue equipment.

GEN 4.1 AERODROME/HELIPORT CHARGES**1. LANDING CHARGES**

1.1 Most aerodromes will have airport specific conditions of use (including access agreements) and landing charge regimes. Aircraft operators should use the contact details listed in ERSA FAC to obtain specific information and/or obtain copies of appropriate documents.

2. PASSENGER MOVEMENT CHARGE

2.1 This section from Airservices Australia AIP not applicable to ADF.

GEN 4.2 AIR NAVIGATION SERVICES CHARGES

1. This section from Airservices Australia AIP not applicable to ADF.



INDEX

A

abbreviations	GEN 2.2 - 27
ADF	
ADF AIP	GEN 3.1 - 1
ADF SAR organisation	GEN 3.6 - 6
aeronautical information service (AIS-AF)	GEN 3.1 - 1
aviation security identification card	GEN 1.2 - 5
civil SAR assistance procedure	GEN 3.6 - 8
defence force cargo	GEN 1.4 - 4
defence meteorological services	GEN 3.5 - 2
DEFLOGMAN biosecurity provisions	GEN 1.3 - 16
foreign aircraft RNP-AR	GEN 1.5 - 4
formation call-signs	GEN 3.4 - 12
helicopter destination safety height	GEN 3.3 - 5
immigration breach prosecution	GEN 1.3 - 5
immigration, commander responsibility	GEN 1.3 - 5
LSALT calculation	GEN 3.3 - 4
meteorological briefing contact numbers	GEN 3.5 - 3
military bases	GEN 1.2 - 9
operations below LSALT	GEN 3.4 - 22
response to civil SAR request	GEN 3.6 - 3
SAR action reports	GEN 3.6 - 8
SAR responsibility and coordination	GEN 3.6 - 1
TCAS occurrence notifications	GEN 1.5 - 3
TCAS operation guidance	GEN 1.5 - 3
units responsible for SAR	GEN 3.6 - 1
ADS-C	
aircraft system functionality	GEN 3.4 - 57
emergency mode	GEN 3.4 - 62
aerodrome forecast	
see TAF	
aerodrome frequency response unit (AFRU)	GEN 3.4 - 5
aerodrome weather information service	
see AWIS	
aerodrome weather reports	GEN 3.5 - 7
aeronautical fixed telecommunication network	
see AFTN	
aeronautical information	
AIS-AF area of coverage	GEN 3.1 - 1
aeronautical information regulation and control	
see AIRAC	
aeronautical information service (AIS)	
responsibility for	GEN 3.1 - 1
AFTN	GEN 3.4 - 6
air traffic services	
see ATS	
AIRAC	
effective dates	GEN 3.1 - 3
airborne collision avoidance system	
see TCAS	
AIRMET	GEN 3.5 - 18
airport warning	
for military aerodromes	GEN 3.5 - 7
AIS-AF	
area of responsibility	GEN 3.1 - 1
provision of AIP to foreign aircrew	GEN 1.2 - 6
area navigation	

LSALT calculationGEN 3.3 - 5
 malfunction, advice to ATCGEN 1.5 - 4
 system approval and operationGEN 1.5 - 4

Army
 see also ADF, Military

aircraft markingsGEN 2.1 - 2
 biosecurity restrictionsGEN 1.4 - 3
 SAR availabilityGEN 3.6 - 8

ATC
 descriptionGEN 3.3 - 1

ATC initiated FISGEN 3.3 - 2

ATISGEN 3.4 - 6

Australia RCC
 contact detailsGEN 3.6 - 1

aviation security identification cardGEN 1.2 - 5

AWISGEN 3.4 - 6

B

biosecurity

airports of entry/departureGEN 1.2 - 6
 army restrictionsGEN 1.4 - 3
 documents required on entryGEN 1.3 - 4
 in-flight announcementGEN 1.3 - 4
 international arrivalsGEN 1.3 - 1
 international non-scheduled flight airportsGEN 1.2 - 8
 pre-arrival reporting requirementsGEN 1.3 - 2
 prohibited importsGEN 1.3 - 4

C

CA/GRS
 available operational informationGEN 3.4 - 4
 emergency responseGEN 3.4 - 5
 SARWATCH capabilityGEN 3.4 - 5
 service parametersGEN 3.4 - 4

call-sign
 ATS unitsGEN 3.4 - 11
 flight number and group formGEN 3.4 - 12
 full and abbreviated formatsGEN 3.4 - 13
 ground vehiclesGEN 3.4 - 12
 special task operationsGEN 3.4 - 14

cargo
 ADF returned, used equipmentGEN 1.4 - 4
 departure reportGEN 1.4 - 2
 foreign military manifestGEN 1.4 - 4
 outwards manifestGEN 1.4 - 2
 personal effects clearanceGEN 1.4 - 4

certified air/ground radio service
 see CA/GRS

charts
 AIREP reporting symbolsGEN 3.5 - 11
 aircservices chart listGEN 3.2 - 1
 for IFR operationsGEN 3.2 - 1
 military chart listGEN 3.2 - 1
 SAR regional boundariesGEN 3.6 - 5
 symbols listGEN 2.3 - 1
 terrain data availabilityGEN 3.1 - 4
 VNCGEN 3.2 - 1
 VTCGEN 3.2 - 1

Christmas Island

customs and immigration	GEN 1.3 - 15
required documents	GEN 1.3 - 14
clearance	
conditional	GEN 3.4 - 7
read-back requirements	GEN 3.4 - 7
Cocos (Keeling) Islands	
customs and immigration	GEN 1.3 - 15
codes	
location indicators, publication details	GEN 2.4 - 1
collocation	
VOR/DME	GEN 3.4 - 2
communications	
alternative language requirements	GEN 3.4 - 8
Australian FIR facilities	GEN 3.4 - 3
continental Australia	GEN 3.4 - 58
distress frequencies	GEN 3.6 - 7
HF use	GEN 3.4 - 3
inter-pilot air to air	GEN 3.4 - 4
language in Australian FIRs	GEN 3.4 - 8
misuse of roger	GEN 3.4 - 16
planning chart Australia details	GEN 1.5 - 1
SELCAL	GEN 3.4 - 4
standard words and phrases	GEN 3.4 - 15
UHF use	GEN 3.4 - 3
VHF primary frequency band	GEN 3.4 - 3
conditional clearance	
criteria for use	GEN 3.4 - 7
format	GEN 3.4 - 7
controller pilot data link communication	
see CPDLC	
conversion	
arc to time table	GEN 2.7 - 2
COSPAS-SARSAT	GEN 3.6 - 4
CPDLC	
connection failure	GEN 3.4 - 61
continental Australia	GEN 3.4 - 58
emergency notification	GEN 3.4 - 62
estimate revision	GEN 3.4 - 61
level reporting	GEN 3.4 - 60
logon procedures	GEN 3.4 - 59
logon rejection	GEN 3.4 - 59
logon request	GEN 3.4 - 57
message elements	GEN 3.4 - 63
message restrictions	GEN 3.4 - 61
position reporting requirements	GEN 3.4 - 60
customs	
ADF computers and cameras	GEN 1.4 - 4
airports of entry/departure	GEN 1.2 - 6
baggage examination	GEN 1.3 - 10
declaration other articles	GEN 1.3 - 11
departure documentation	GEN 1.3 - 10
departure report	GEN 1.3 - 10
departure report cargo	GEN 1.4 - 2
duty & tax payments	GEN 1.3 - 10
entry control point	GEN 1.3 - 4
export permits	GEN 1.3 - 10
general declaration departing flights	GEN 1.3 - 10
incoming passenger documents	GEN 1.3 - 9
military exercise exemptions	GEN 1.4 - 4
outwards manifest cargo	GEN 1.4 - 2
personal effects	GEN 1.4 - 4

D

data link
 Australian ATC coverage GEN 3.4 - 57
 date and time system GEN 2.1 - 1
 daylight and darkness graphs
 graph GEN 2.7 - 3
 graph limitations GEN 2.7 - 1
 defence weather service office
 see DWSO
 definitions of aeronautical terms GEN 2.2 - 1
 DEFLOGMAN
 ADF biosecurity provisions GEN 1.3 - 16
 distance measuring equipment
 see DME
 distress frequencies GEN 3.6 - 7
 ditching GEN 3.6 - 2
 DME
 associated VOR GEN 3.4 - 2
 not associated with VOR GEN 3.4 - 2
 pairing GEN 3.4 - 2
 rated coverage GEN 1.5 - 1
 document presentation
 DME GEN 3.4 - 2
 documents
 foreign military request process GEN 1.2 - 6
 radio telephony procedures GEN 3.4 - 6
 DWSO
 service scope, locations GEN 3.5 - 4

E

east coast SSR coverage GEN 2.2 - 8
 electronic travel authorities GEN 1.3 - 6
 ELT GEN 3.6 - 3
 emergency locator transmitter
 see ELT
 emergency notification
 CPDLC GEN 3.4 - 62
 emergency phases
 advice to operator GEN 3.6 - 2
 ATS relay of advice GEN 3.6 - 2
 emergency response
 aircraft intercept and escort GEN 3.6 - 2
 ditching GEN 3.6 - 2
 failure to report GEN 3.6 - 2
 navigation assistance GEN 3.6 - 2
 radio failure GEN 3.6 - 2

F

first light
 NAIPS computations GEN 2.7 - 1
 FIS
 criteria for ATC initiated GEN 3.3 - 2
 fleet weather and oceanographic centre GEN 3.5 - 4
 flight note
 JRCC contact when overdue GEN 3.6 - 2
 flight planned route GEN 3.4 - 8
 forecast
 amendment timing GEN 3.5 - 7

limitations	GEN 3.5 - 4
mercy and SAR flight provision	GEN 3.5 - 10
notification for international operations	GEN 3.5 - 10
notification GAF not available	GEN 3.5 - 10
operations above 10000ft	GEN 3.5 - 5
foreign aircraft	
SAR operations	GEN 3.6 - 5
foreign military	
AIS-AF document provision to	GEN 1.2 - 6
customs inspection of cargo	GEN 1.4 - 4
customs, immigration and biosecurity facilities at ADF bases	GEN 1.2 - 9
entry approval for SAR	GEN 3.6 - 5
foreign state aircraft	
diplomatic clearance	GEN 1.2 - 3
diversion within Australia	GEN 1.2 - 5
entry for SAR	GEN 3.6 - 5
entry requirements	GEN 1.2 - 4
exercise participation	GEN 1.2 - 4
formation flight	
civil formation call-signs	GEN 3.4 - 13
military group form	GEN 3.4 - 12
frequency	
coverage publication details	GEN 3.4 - 3
interpilot air-to-air	GEN 3.4 - 4
NDB range	GEN 3.4 - 2
VOR band	GEN 3.4 - 2
frequency band	
VOR	GEN 3.4 - 2
G	
GAF	
operations at or below 10000ft	GEN 3.5 - 6
GBAS	
rated coverage	GEN 1.5 - 1
global positioning system	
see GPS	
GNSS	
LSALT calculation	GEN 3.3 - 5
GPS	GEN 3.4 - 3
graph	
beginning and end of daylight calculations	GEN 2.7 - 1
grid LSALT	
application of navigation error	GEN 3.3 - 4
display format	GEN 3.3 - 4
grid point wind and temperature forecasts	GEN 3.5 - 5
H	
helicopter	
RAN SAR equipment	GEN 3.6 - 8
helicopter destination safety height	GEN 3.3 - 5
high vertical rate encounters	
see TCAS	
I	
I	GEN 3.1 - 2
ICAO standards	
Australian differences	GEN 1.7 - 1
identification	

corrupt or not received	GEN 3.4 - 3
ILS and localiser	GEN 3.4 - 2
radio NAVAID prior to use	GEN 3.4 - 3
radio navigation aids	GEN 3.4 - 2
IFR	
charts	GEN 3.2 - 1
GPS limitations	GEN 3.4 - 3
ILS	
identification	GEN 3.4 - 2
immigration	
airports of entry/departure	GEN 1.2 - 6
certificate of identity	GEN 1.3 - 6
crew documents	GEN 1.3 - 9
entry visa to Australia	GEN 1.3 - 5
examination of passengers	GEN 1.3 - 9
incoming passenger documents	GEN 1.3 - 9
passenger documents	GEN 1.3 - 9
pilot responsible for non-citizen entry	GEN 1.3 - 5
in-flight information service	
scope	GEN 3.3 - 2
international agreement and conventions	GEN 1.6 - 1
international airport	
Australian external territories, pavement strengths	GEN 1.3 - 14
international flights	
arrival and departure airport requirements	GEN 1.2 - 1
customs outward clearance	GEN 1.3 - 10
emergency landing en-route	GEN 1.3 - 12
migration regulations	GEN 1.3 - 5
notification for forecasts	GEN 3.5 - 10
pavement concessions in Australia	GEN 1.2 - 6
J	
JRCC Australia	
responsibilities	GEN 3.6 - 1
L	
language	
Australian FIRs communications	GEN 3.4 - 8
last light	
NAIPS computations	GEN 2.7 - 1
level reporting	
accuracy	GEN 3.4 - 46
CPDLC	GEN 3.4 - 60
levels	
RVSM airspace	GEN 1.5 - 4
localiser	
identification	GEN 3.4 - 2
rated coverage	GEN 1.5 - 1
location indicators	GEN 2.4 - 1
logon procedures	
CPDLC	GEN 3.4 - 59
LSALT	
calculation for routes defined by radio aid	GEN 3.3 - 4
calculation of	GEN 3.3 - 4
effective area explanatory figures	GEN 3.3 - 6
IFR flight limitations	GEN 3.3 - 4
operations below	GEN 3.4 - 22
route segments not on ERC or TAC	GEN 3.3 - 4

M

M	GEN 3.1 - 2
major international airports	
customs, immigration and biosecurity services	GEN 1.2 - 6
marshalling signals	GEN 3.4 - 67
cable operations	GEN 3.4 - 72
day	GEN 3.4 - 67
general	GEN 3.4 - 67
marshaller position	GEN 3.4 - 67
night	GEN 3.4 - 67
rotary wing aircraft	GEN 3.4 - 72
used by pilot	GEN 3.4 - 67
VTOL aircraft	GEN 3.4 - 72
mean equivalent wind components	GEN 3.5 - 19
calculation method and example	GEN 3.5 - 19
K factor table	GEN 3.5 - 19
route and distance datum	GEN 3.5 - 19
mean equivalent wind table	
DEC-MAY	GEN 3.5 - 20
JUN-NOV	GEN 3.5 - 34
mean seasonal ambient temperatures	GEN 3.5 - 19
measurement	
units	GEN 2.1 - 1
message elements	
CPDLC	GEN 3.4 - 63
message restrictions	
CPDLC	GEN 3.4 - 61
meteorological briefing	
telephone contact	GEN 3.5 - 3
meteorological broadcasts	
automatic	GEN 3.5 - 12, GEN 3.5 - 18
meteorological reports	GEN 3.5 - 10
meteorology	
airborne weather radar	GEN 1.5 - 1
military	
see also ADF, Army, RAAF, RAN	
aeronautical information source	GEN 3.1 - 1
military aircraft	
communications facilities	GEN 3.4 - 3
military exercise	
customs exemption criteria	GEN 1.4 - 4

N

NAIPS	
first and last light computations	GEN 2.7 - 1
national regulations summary	GEN 1.6 - 1
navigation error	
application of grid LSALT	GEN 3.3 - 4
NDB	
bearing fluctuation range	GEN 3.4 - 2
rated coverage	GEN 1.5 - 1, GEN 3.4 - 2
night	
definition	GEN 2.7 - 1
noise abatement	
aircraft noise restrictions	GEN 1.2 - 6
non-contracting state	
SAR operations approval	GEN 3.6 - 6
security measures SAR aircraft	GEN 3.6 - 6
non-directional beacon	
see NDB	

Norfolk Island
 customs and immigration GEN 1.3 - 16
 required documents GEN 1.3 - 15

NOTAM
 register and series GEN 3.1 - 2

notification
 abnormal operation of radio NAVAID GEN 3.4 - 2
 aircraft unable to use measurement units GEN 2.1 - 1

numbers
 general pronunciation GEN 3.4 - 9
 phonetic pronunciation GEN 3.4 - 9

NVG
 phraseology GEN 3.4 - 22

P

pairing
 DME GEN 3.4 - 2
 VOR GEN 3.4 - 2

passenger
 customs baggage examination GEN 1.3 - 10
 entry documents required GEN 1.3 - 4
 immigration examination GEN 1.3 - 9
 in-transit change to disembarking GEN 1.3 - 11

passenger card GEN 1.3 - 11

passport
 domestic sectors GEN 1.3 - 6
 entry to Australia GEN 1.3 - 5
 exemptions GEN 1.3 - 5
 family groups GEN 1.3 - 5

pavement concession
 international flights GEN 1.2 - 6

phraseology
 ADS-C GEN 3.4 - 55
 aerodrome movements GEN 3.4 - 42
 after take-off GEN 3.4 - 46
 approach and area control services GEN 3.4 - 36
 approach radar services GEN 3.4 - 55
 arrival at aerodrome GEN 3.4 - 47
 ATS surveillance service GEN 3.4 - 50
 clearances GEN 3.4 - 29
 frequency management GEN 3.4 - 24
 general phrases GEN 3.4 - 21
 helicopter operations GEN 3.4 - 45
 meteorological information GEN 3.4 - 26
 pushback GEN 3.4 - 39
 reports and information GEN 3.4 - 27
 runway operations GEN 3.4 - 43
 safety alert and avoiding action GEN 3.4 - 18
 SARWATCH GEN 3.4 - 20
 speechless radar approach GEN 3.4 - 57
 speed control GEN 3.4 - 52
 SSR and ADS-B GEN 3.4 - 54
 STAR GEN 3.4 - 34
 starting and initial clearance GEN 3.4 - 38
 status of restricted areas GEN 3.4 - 20
 surveillance system manoeuvres GEN 3.4 - 51
 TCAS GEN 3.4 - 18
 traffic information GEN 3.4 - 25, GEN 3.4 - 53
 vicinity of aerodrome GEN 3.4 - 38

visual identification	GEN 3.4 - 38
wind shear escape manoeuvres	GEN 3.4 - 19
pilot actions	
speechless radar approach	GEN 3.4 - 57
pilot responsibility	
grid LSALT application to navigation error	GEN 3.3 - 4
landing at other than nominated AD	GEN 3.6 - 2
SAR debriefing	GEN 3.6 - 3
SAR search briefing	GEN 3.6 - 3
plain language	
circumstances for use	GEN 3.4 - 6
planning chart Australia	
communications details	GEN 3.2 - 1
planning chart Australia (PCA)	GEN 3.2 - 1
position report	
format	GEN 3.4 - 27
position reporting requirements	
CPDLC	GEN 3.4 - 60
pratique	
definition	GEN 1.3 - 3
preflight briefing	
provision details	GEN 3.3 - 2
preflight information service	
contact details	GEN 3.1 - 4
location and contacts	GEN 3.1 - 4
prohibited	
imports	GEN 1.3 - 4
public holidays	
airspace activation status	GEN 2.1 - 2
national public holidays	GEN 2.1 - 2

R

RAAF

see also ADF, Military.

long range oceanic SAR	GEN 3.6 - 8
SAR responsibility	GEN 3.6 - 1
radio	
transmission format	GEN 3.4 - 7
radio failure	
response action	GEN 3.6 - 2
radio navigation aid	
abnormal operation notification	GEN 3.4 - 2
broadcast station as supplementary aid	GEN 3.4 - 2
GPS	GEN 3.4 - 3
identification	GEN 3.4 - 2
identification prior to use	GEN 3.4 - 3
identifier function when aid not usable	GEN 3.4 - 3
not available for navigation	GEN 3.4 - 3
signal corrupt or not received	GEN 3.4 - 3
types	GEN 3.4 - 1
radio navigation aids	
format for listing	GEN 2.5 - 1
publication details	GEN 2.5 - 1
radio navigation systems	
rated coverage	GEN 1.5 - 1
radio telephony	
document details	GEN 3.4 - 6
general phrases	GEN 3.4 - 21
phonetic alphabet	GEN 3.4 - 8

phonetic numbersGEN 3.4 - 9

standard words and phrasesGEN 3.4 - 15

standardisationGEN 3.4 - 6

RAN

see also ADF, Military

Fleet Weather & Oceanographic CentreGEN 3.5 - 4

helicopter SAR equipmentGEN 3.6 - 8

SAR facilitiesGEN 3.6 - 8

SAR responsibilityGEN 3.6 - 1

rated coverage

radio navigation systemsGEN 1.5 - 1

read-back

complianceGEN 3.4 - 7

formatGEN 3.4 - 7

level informationGEN 3.4 - 7

runway expectationGEN 3.4 - 7

rescue coordination centresGEN 3.6 - 1

rotary wing

marshalling signalsGEN 3.4 - 72

route clearance

read-backGEN 3.4 - 7

RVSMGEN 1.5 - 4

operating levelsGEN 1.5 - 4

S

SAR

ABXO responsibilitiesGEN 3.6 - 6

ADF admin contact detailsGEN 3.6 - 1

ADF availabilityGEN 3.6 - 8

airservices australia responsibilityGEN 3.6 - 1

ArmyGEN 3.6 - 8

briefing responsibilityGEN 3.6 - 8

BSARO responsibilitiesGEN 3.6 - 7

callsigns for ADF aircraftGEN 3.6 - 7

civil assistance requestGEN 3.6 - 3

communications proceduresGEN 3.6 - 8

defence aid to civilian communityGEN 3.6 - 8

description of assistance providedGEN 3.6 - 1

distress frequencies listGEN 3.6 - 7

entry of foreign aircraftGEN 3.6 - 5

flight notification implicationsGEN 3.6 - 2

foreign civil operationsGEN 3.6 - 5

foreign state aircraft operations criteriaGEN 3.6 - 5

in-flight reportsGEN 3.6 - 8

JRCC AustraliaGEN 3.6 - 1

liaison civil authoritiesGEN 3.6 - 8

local commander authorityGEN 3.6 - 8

media releaseGEN 3.6 - 7

military command structureGEN 3.6 - 6

military standby aircraftGEN 3.6 - 8

non-contracting state operationsGEN 3.6 - 6

non-international airport entryGEN 3.6 - 6

photographsGEN 3.6 - 8

post flight reportsGEN 3.6 - 8

post mission reportsGEN 3.6 - 8

public affairs officerGEN 3.6 - 7

RAAFGEN 3.6 - 1

RANGEN 3.6 - 1

RCC Australia post mission reportGEN 3.6 - 8

regional boundariesGEN 3.6 - 5

request for military assistance	GEN 3.6 - 3
rescue coordination centre contact details	GEN 3.6 - 1
search briefing	GEN 3.6 - 3
search debriefing	GEN 3.6 - 3
SMC responsibilities	GEN 3.6 - 6
task costing message	GEN 3.6 - 8
SART	
action on receipt of transmission	GEN 3.6 - 4
carriage requirement	GEN 3.6 - 4
interference	GEN 3.6 - 4
operating details	GEN 3.6 - 4
response transmission rate	GEN 3.6 - 4
visual presentation example	GEN 3.6 - 4
SARWATCH	
CA/GRS authority	GEN 3.4 - 5
flight note notification	GEN 3.6 - 2
search and rescue - see SAR	
search and rescue transponder	
- see SART	
secondary surveillance radar - see SSR	
SELCAL	
frequency publication details	GEN 3.4 - 4
SIGMET	
ATC initiated FIS	GEN 3.3 - 2
dissemination by ATS	GEN 3.5 - 17
signals	
marshalling	GEN 3.4 - 67
speed measurement units	GEN 3.4 - 52
SSR transponder	
aircraft requirements	GEN 1.5 - 2
standard words and phrases	GEN 3.4 - 15
stop bars	
vehicle and pedestrian control	GEN 3.3 - 12
symbols	
aeronautical charts	GEN 2.3 - 1
T	
TACAN	GEN 3.4 - 2
at joint-user aerodromes	GEN 3.4 - 2
frequency display on chart	GEN 3.4 - 2
paired DME & VOR	GEN 3.4 - 2
rated coverage	GEN 1.5 - 1
tactical air navigation aid	
see TACAN	
TCAS	
actions following RA	GEN 1.5 - 3
conditions for use	GEN 1.5 - 3
high vertical rate encounters	GEN 1.5 - 4
resolution advisory actions	GEN 1.5 - 3
traffic advisory actions	GEN 1.5 - 3
telephone briefing	
first and last light	GEN 2.7 - 1
time	
conversion from arc table	GEN 2.7 - 2
system	GEN 2.1 - 1
time zones	
Australian zones	GEN 2.7 - 1
tolerance	
level report	GEN 3.4 - 46
traffic information	
CA/GRS	GEN 3.4 - 4

transmission
 format of messageGEN 3.4 - 7
 read-back formatGEN 3.4 - 7

U

UAV
 call-signsGEN 3.4 - 13
 unicomGEN 3.4 - 5
 availabilityGEN 3.4 - 5
 licence requirementGEN 3.4 - 5
 message typesGEN 3.4 - 5
 operator and pilot responsibilityGEN 3.4 - 5
 weather reportsGEN 3.4 - 5
 unit badges
 application to army aircraftGEN 2.1 - 2
 units
 speedGEN 3.4 - 52
 units of measurementGEN 2.1 - 1
 UTCGEN 2.1 - 1
 aviation standardGEN 2.1 - 1

V

VHF
 estimated coverage depictionGEN 3.4 - 3
 planning chart Australia useGEN 3.2 - 1
 VHF omni-directional radio range - see VOR
 visa
 requirementsGEN 1.3 - 6
 special category visaGEN 1.3 - 8
 special purpose visaGEN 1.3 - 7
 visual chartsGEN 3.2 - 1
 VNCGEN 3.2 - 1
 VOR
 associated DMEGEN 3.4 - 2
 frequency bandGEN 3.4 - 2
 rated coverageGEN 1.5 - 1
 track radial designationGEN 3.4 - 2
 VTCGEN 3.2 - 1
 operating level coverageGEN 3.2 - 1
 PRD detailsGEN 3.2 - 2
 VTOL aircraft
 marshalling signalsGEN 3.4 - 72

W

WATIRGEN 3.5 - 18
 weather reports
 unicomGEN 3.4 - 5
 wind shear
 warningsGEN 3.5 - 8
 world area forecast systemGEN 2.2 - 26

GPA - AREA OF COVERAGE

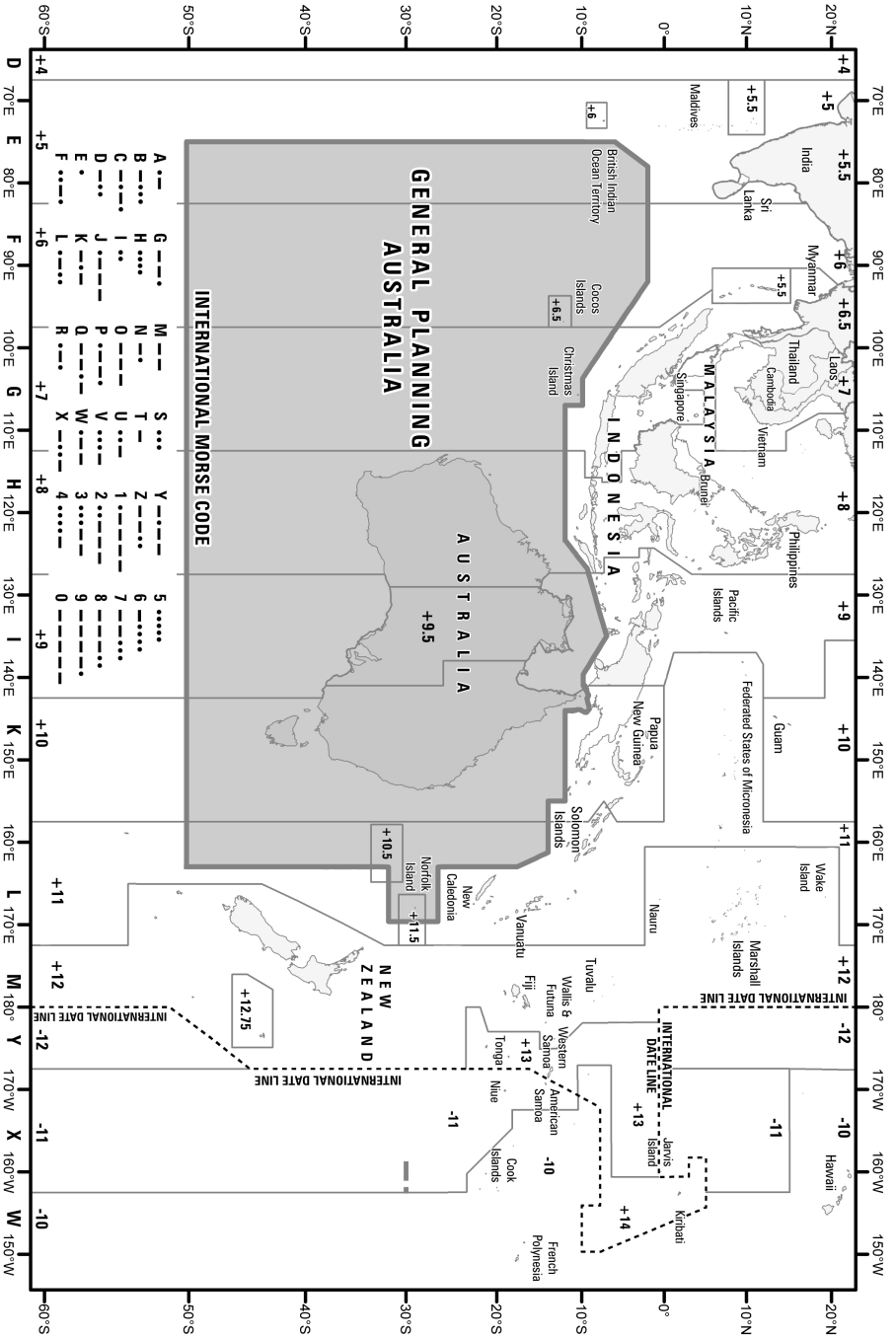

GPA - AREA OF COVERAGE